

Passionate about Particulate

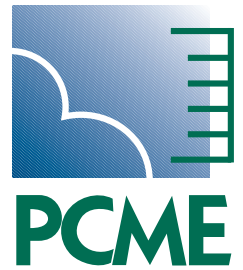

PCME STACK 990

ELECTRODYNAMIC™
INSIDE

Particulate

Measurement

System

TUV and MCERTS
Approved
Particulate CEM



- Extensively used for measurement (mg/m^3) and leak location in bagfilter stack applications
- Upgradeable to include control for up to 16 sensors plus additional 16 calculated channels (eg Mass or normalised concentration)
- Advanced sensor design includes zero, span and unique contamination checks



Certificate No: 9389

technology/applications

System Description

The **PCME STACK 990** is an approved particulate measurement system for continuously monitoring emissions from industrial sources. It is predominantly used to monitor particulate emissions in stacks after bag filters, cartridge filters, cyclones and process driers. The instrument combines regulatory approvals (MCERTS and TUV BlmSchV 17 and 13) for both dust measurement and leak monitoring, with reliable automatic quality assurance features, rugged operation and advanced diagnostics capability for managing and improving the operation of bagfilter arrestment plant. The **PCME STACK 990 PLUS** is a multi-sensor networked system (up to 16) for multi-stack and plant wide monitoring.

The standard and **PLUS** versions of the instrument also include internal data logging suitable for emission recording and data archiving and support the following capability:

- Normalisation for T and O₂ (assumes inputs from other analysers).
- Mass calculation (kg/year) capability for both fixed and varying velocity applications (varying velocity requires velocity input).
- Emission reporting and data analysis via optional PC software.
- Advanced graphic and user interface screens.

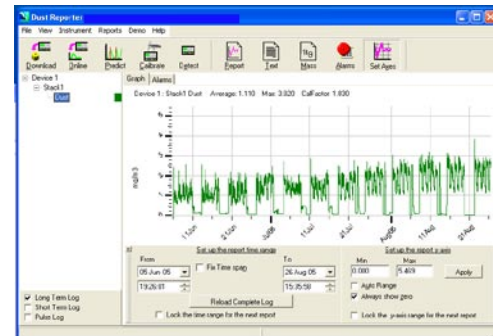

Graph showing increasing dust emissions from fabric filter deteriorating over time

ATEX compliance

An EX (Category 1, 2 and 3 ATEX and IECEx) version of the instrument is optionally available for EX Dust Zones 20, 21 and 22. This system is approved by an independent notified body and uses intrinsic safety (sensor rod) and energy limitation as its protection method. The system is provided with a sensor earth strap (must be connected to stack) and an isolating spur which connects between the sensor rod and control unit. Note: For EX gas zones, the intrinsically safe PCME View 800 series instruments with Category 1, 2 and 3 approval is available.

Process and Application Conditions



- Certification range: 0-15mg/m³ (TUV).
- Long term zero drift: <0.1mg/m³.
- Measurement capability: 0-500mg/m³.
- For measurement in non-condensing flue gases.
- For stack measurement but not suitable for Electrostatic precipitators or applications with water droplets.
- For use in processes with flow of 8m/s-20m/s with no restrictions. Constant velocity required outside this range.
- For stack diameters: 100mm to 6m (flow profile dependent on larger stacks).

Principles of Operation

The instrument uses PCME's unique and patented *ElectroDynamic*TM Probe Electrification technology. The sensor electronics measures the current signature created by particles interacting with the grounded sensing rod which protrudes into the stack. The electronics extract a specific frequency band of this signal and electronically filters out the dc current caused by particle collisions. This signal may be correlated to dust concentration by comparison to the results of an iso-kinetic sample for those types of industrial stack applications for which the instrument is designed (see application conditions).

Core features of the *ElectroDynamic*TM Probe Electrification technology are that the signal generated is:

- Unaffected by contamination on the sensor rod (which may cause signal drift issues for other systems).
- Not affected by velocity variations within typical bagfilter velocity ranges (see separate TUV approvals for PCME Ltd technology).
- Reliable and stable in the target applications for the instrument (see Process Conditions). Identical PCME technology to this is used in the PCME QAL 991 instrument which was the first ever probe electrification instrument to become TUV and MCERTS approved against the exacting standards of EN 15267-3 for QALI.

Technology Comparisons and Benefits

Compared to other types of AC systems, *ElectroDynamic*TM Systems has the following added benefit:

- An optimised frequency spectrum to extend the velocity range over which the system has no cross sensitivity to changing velocity (see TUV approvals).

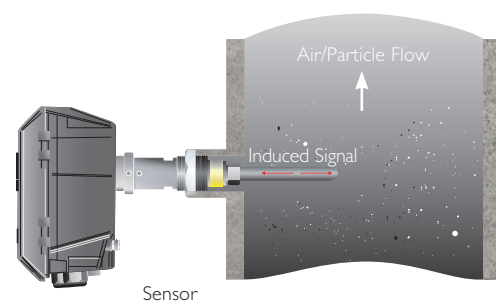

ELECTRODYNAMICTM

Compared to DC triboelectric systems and 'induction sensing and protected probe systems', *ElectroDynamic*TM systems have the following added benefits:

- Tolerance to contamination on the rod.
- Stable results and calibrations (protected probes are not necessary in dry applications and therefore drift caused by electrostatic charging effects is avoided).
- Reduced sensitivity to the effects of changing velocity.

product features

Added Value Features

The **PCME STACK 990** includes an advanced level of automatic functionality checks to provide high quality assurance:

- A probe rod short circuit check – enables the operator to know when the sensing rod may be electrically shorted to the stack and avoid associated errors.
- A patented probe rod contamination check provides the operator with a pre-warning check of possible probe short circuit enabling predictive sensor maintenance scheduling, lower down times and confidence of signal quality.
- Automatic electronic zero and drift checks - improves measurement reliability and ensures that the instrument is in compliance to regulatory standards (TUV, MCERTS, US EPA). These checks are done in the sensor to ensure the major part of the instrument is challenged during these tests.



Advanced probe contamination check

The system includes advanced signal processing and diagnostics to permit a plant operator to locate the position of leaking bags as well as improve the quality of emission measurement:

- Rapid dynamic ranging of 10,000:1 permitting bag cleaning pulses to be accurately monitored while maintaining high accuracy in background emission measurement. Sufficient dynamic range is provided to follow "on-line" and "off-line" bag cleaning cycles for predictive filter failure and faulty bag location detection.
- Rolling digital average calculations for accurate emission measurement.

A range of ruggedized sensor options for challenging stack applications are also available:

- A patented insulated sensing rod option for use in high humidity and condensing gas applications. This gives the instrument unrivalled performance in process drier applications.
- An active/passive design to eliminate any concerns or effects of condensation in the stack connection stub.
- Enhanced corrosion protection (wetted parts).

System Layout

The **PLUS** version of the instrument permits up to 16 sensors to be connected to a single central control unit. The control unit provides power for the sensors (additional Power Supply Units (PSU) required on larger systems) and industry standard outputs (4-20mA, RS232/RS485 Modbus) are provided for easy connection to plant control systems. The control unit also comprises a powerful data logging capability to permit process and regulatory reporting. In addition, other PCME modbus sensors can be connected to the control unit.

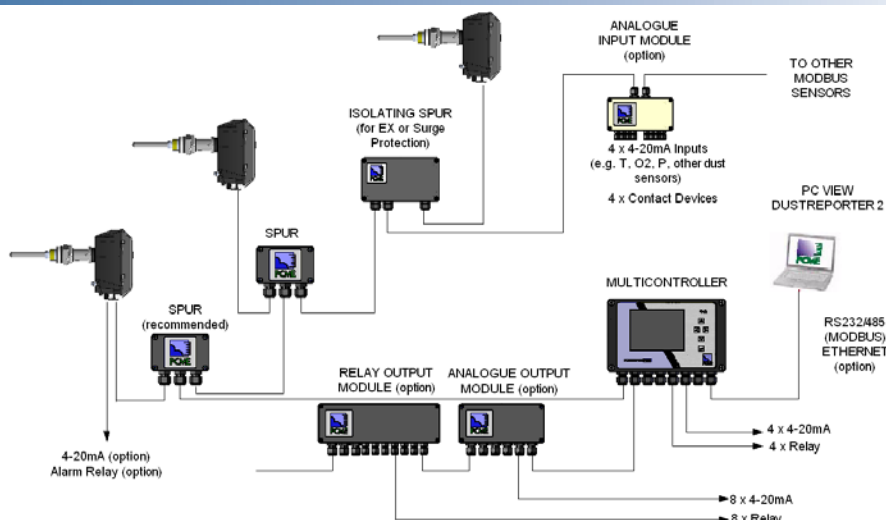

Control Unit Options

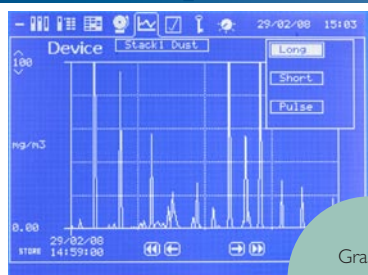

Graphics screen showing pulse cleaning

Calibration screen permits averaging of logged data

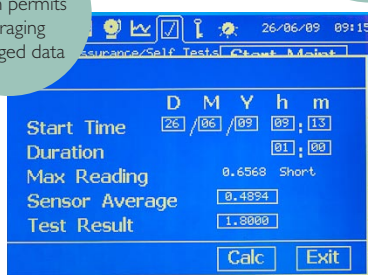

Standard System

PLUS System

	Standard System	PLUS System
Controller Type	Interface module	MultiController
No of Sensor Channels	1	1-16
ICON Driven Multilingual Menu	Emission and Alarm levels Quality Assurance results Calibration screens Review data logs Show graph and bar chart Set up and password Advanced calculations (Mass, normalisation)	Emission and Alarm levels Quality Assurance results Calibration screens Review data logs Show graphs and multi bar charts Set up and password Advanced calculations (Mass, normalisation)
Bagfilter Optimisation Diagnostics	Pulse log review for diagnosing location of leaking bags	Pulse log review for diagnosing location of leaking bags
Emission Data Logs	Capacity stated for 1 sensor 12 months @ 15 minutes 7 days @ 1 minute 2 hours @ 1 second 500 entries	Capacity stated for 4 sensors 12 months @ 15 minutes 7 days @ 1 minute 2 hour @ 1 second 500 entries
Ethernet Enabled Option	None	Ethernet (Modbus TCP) (optional)
Outputs	1 x RS-485 (Modbus RTU) 1 x 4-20mA (500 ohm) 2 x Relay (2A@250V, user selectable)	1 x RS-485 (Modbus RTU) 4 x 4-20mA (500 ohm) 4 x Relay (2A@250V, user selectable)
Inputs	1 input for plant off indication, bag cleaning reference and multiple calibrations	4 inputs for plant off indication, bag cleaning reference and multiple calibrations
Enclosure Size (mm)	220 W x 123 H x 80 D	263 W x 160 H x 91 D
Power Supply	90 to 260 VAC (50/60Hz), 1A	90 to 260 VAC (50/60Hz), 1A

Note: Local 4-20mA and Relay output also available from each sensor (option) and from optional accessory components (option).



specifications

Dimensions

Standard Sensor 0-250°C

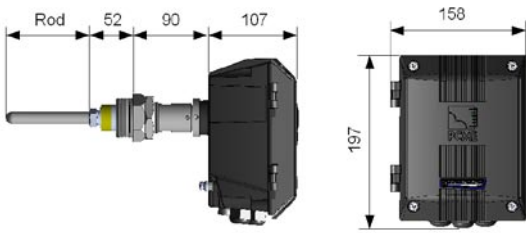

Passive/Active Sensor 0-250°C

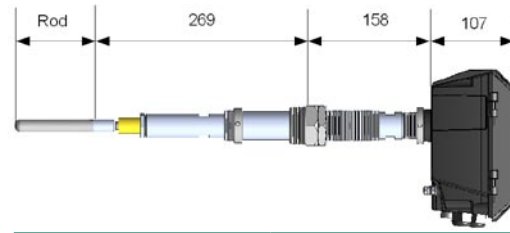

Standard Sensor 0-800°C

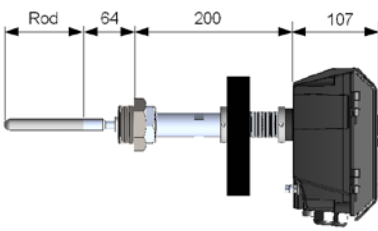

Insulated Sensor 0-250°C

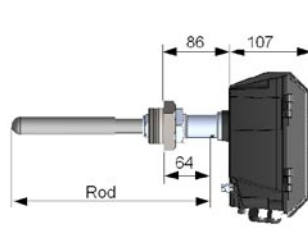

Enclosure Temperature Rating	-25°C to +55°C
Enclosure Rating	IP65
Enclosure Material	Die-cast aluminum (polyester powder coated)
Connection Required on Duct	1.5" BSP (female) Ensure opening/hole in stack wall is at least 45mm
Power Requirements	24V provided by the control unit
Cable Entries	3 x M20 gland/conduit entries
Air Purge Requirements	May be required on some applications (consult PCME). Requires optional air purge fitting and external supply of 5-10 litres/min of dry clean, oil free instrument air

Order Codes

PCME STACK 990 [single channel]
PCME STACK 990 PLUS [multi channel]

Control Unit Options

CON 990 – A B

A	Controller	PLUS version (MultiController) Standard version (Interface Module)	M I
B	Ethernet	None Ethernet fitted (PLUS version only)	0 ET

Example: CON 990

1	2
M	ET

System Options

4-core Cable	Specify length required (10m per sensor included as standard)	CAB4
Spur	Divides cable into 2 branches	SPR
Power Supply/Repeater	Voltage and signal boost for extended cabling runs with multiple sensors	PWR
Analogue Input Module (AIM)	4 x 4-20mA inputs 4 x Digital inputs	AIM
Analogue Output Module (AOM)	8 x 4-20mA (500 Ohm)	AOM
Alarm Output Module (ROM)	8 x Relay (1A @ 250V)	ROM
Isolating Spur	Provides Surge protection	SPR-X

PC Software Options (PC-ME Dust Tools)

Configuration Options	System Set
Real-time Data Options	On-line Predict
Historical Data Options	Data Downloader Data Viewer Data Reporter Predict View

Sensor Options

SEN 990 – 1 2 3 (4 5 6 7)

1	Sensor Type	Standard sensor 0-250°C Insulated sensor 0-250°C Passive/active sensor 0-250°C Standard sensor 0-400°C Passive/active sensor 0-400°C Standard sensor 0-800°C Passive/active sensor 0-800°C Standard sensor 0-400°C 0-10bar	250S 250I 250P 400S 400P 800S 800P 400SP
2	Rod Length	0100-1000mm *	RODxxxx
3	ATEX/IECEx Category	None ATEX: Category 3 dust (zone 22) ** ATEX: Category 1 dust (zone 20) *** IECEx: Category 1 dust (zone 20) ***	0 X22 X20 I20

*limited to 800mm on 400°C, 800°C and passive/active versions.

**standard 250°C and passive/active 250°C only.

***standard 250°C only. Isolating spur provided with sensor.

Sensor Accessories

4	Air Purge Fitting	None Air purge fitting	0 AP
5	Air Filter/Regulator	None Filter + regulator assembly	0 REG
6	Stack Connection	1.5" BSP (standard) Flange Flanged air purge adapter Wetted parts (Hastelloy ®) (up to 250°C) Wetted parts (Hastelloy ®) (up to 600°C)	0 FL FAPA H250 H600
7	Local 4-20mA and Relay	None Local 4-20mA and Alarm Relays	0 420L

Example: SEN 990

1	2	3	4	5	6	7
250S	ROD0500	X20	AP	REG	0	420L

About PCME Ltd

As a progressive environmental Company, PCME specialises in particulate measurement for industrial processes. With a worldwide reputation for reliability, innovation and technological excellence, the Company produces equipment for concentration and mass monitoring for regulatory, environmental and process control requirements. A dedicated team of qualified application and sales engineers is always on hand and should be consulted in the selection and usage of the most suitable equipment for any particulate application.

PCME Ltd
 Clearview Building
 60 Edison Road
 St Ives Cambs UK
 PE27 3GH

Contact your national or area sales and service office



Tel: +44 (0)1480 468200
 Fax: +44 (0)1480 463400
 E-mail: contact@pcme.co.uk
www.pcme.co.uk