



testo 340  
Flue gas analyser

Instruction manual

en









# General notes

Please read this documentation through carefully and familiarise yourself with the operation of the product before putting it to use. Keep this document to hand so that you can refer to it when necessary.

This document describes the country-specific version **GB** of the testo 340 measuring instrument.

## Identification

Symbol	Meaning	Comments
 Warning!	Warning advice: Warning! Serious physical injury could be caused if the specified precautionary measures are not taken.	Read the warning advice carefully and take the specified precautionary measures!
 Caution!	Warning advice: Caution! Slight physical injury or damage to equipment could occur if the specified precautionary measures are not taken.	Read the warning advice carefully and take the specified precautionary measures!
	Important note.	Please take particular notice.
<b>Text</b>	Text appears on the instrument's display	-
	Key	Press the key.
	Function key with the function "OK".	Press function key.
 → xyz	Short form for operating steps.	See <i>Short form</i> , p. 3.







### Short form

This document uses a short form for describing steps (e.g. calling up a function).

Example: Calling up the **Flue gas** function

Short form:  → **Measurements** →  → **Flue gas** →   
(1)            (2)            (3)            (4)            (5)

Steps required:

- 1 Open the Main menu: .
- 2 Select **Measurements** menu: , .
- 3 Confirm selection: .
- 4 Select **Flue gas** menu: , .
- 5 Confirm selection: .

# Content

! See also *Functional overview*, p. 60.

General notes .....	2
Content .....	4
<b>A. Safety advice .....</b>	<b>7</b>
<b>B. Intended purpose .....</b>	<b>9</b>
<b>C. Product description .....</b>	<b>10</b>
C.1 Measuring instrument .....	10
C.1.1 Overview .....	10
C.1.2 Keypad .....	11
C.1.3 Display .....	11
C.1.4 Instrument connections .....	12
C.1.5 Interfaces .....	13
C.1.6 Components .....	13
C.1.7 Carrying strap .....	14
C.2 Modular flue gas probe .....	14
<b>D. Commissioning .....</b>	<b>14</b>
<b>E. Operation .....</b>	<b>15</b>
E.1 Mains unit/rechargeable battery .....	15
E.1.1 Changing the battery .....	15
E.1.2 Charging batteries .....	16
E.1.3 Operation with the mains unit .....	16
E.2 Probes/sensors .....	17
E.2.1 Connecting probes/sensors .....	17
E.2.2 Replacing the probe module .....	18
E.3 Regular care .....	18
E.3.1 Condensate trap .....	18
E.3.2 Checking/replacing the particle filter .....	19

E.4	Basic operating steps .....	19
E.4.1	Switching the measuring instrument on .....	19
E.4.2	Calling up the function .....	20
E.4.3	Entering values .....	20
E.4.4	Printing data .....	21
E.4.5	Saving data .....	21
E.4.6	Confirming an error message .....	21
E.4.7	Switching the measuring instrument off .....	21
E.5	Memory .....	22
E.5.1	Folders .....	22
E.5.2	Location .....	23
E.5.3	Protocols .....	24
E.5.4	Extras Memory .....	25
E.6	Instrument diagnosis .....	26
<b>F.</b>	<b>Configuration .....</b>	<b>26</b>
F.1	Instrument settings .....	27
F.1.1	Display edit .....	27
F.1.2	Printer .....	28
F.1.3	Start keys edit .....	29
F.1.4	AutoOff .....	29
F.1.5	Communication .....	30
F.1.6	Date/Time .....	30
F.1.7	Language .....	30
F.2	Sensor settings .....	31
F.3	Fuels .....	35
<b>G.</b>	<b>Measuring .....</b>	<b>36</b>
G.1	Preparing measurements .....	36
G.1.1	Zeroing phases .....	36
G.1.2	Using the modular flue gas probe .....	37
G.1.3	Configuring the reading display .....	37
G.1.4	Set location/fuel .....	37
G.2.1	Flue gas, Flue gas + m/s, Flue gas + Dp2 .....	38
G.2.2	Program .....	39
G.2.3	Draught .....	40
G.2.4	Smoke#/HCT .....	40
G.2.5	Gas flow rate .....	41
G.2.6	Oil flow rate .....	42
G.2.7	m/s .....	42
G.2.8	Dp2 .....	43
G.2.9	Burner control .....	43



## 6 Content

<b>H.</b>	<b>Transferring data</b>	<b>45</b>
H.1	Protocol printer	45
<b>I.</b>	<b>Care and maintenance</b>	<b>46</b>
I.1	Cleaning the measuring instrument	46
I.2	Replacing sensors	46
I.3	Filter for CO, H <sub>2</sub> -comp., NO exchanging sensors	47
I.4	Recalibrating sensors	47
I.5	Cleaning the modular flue gas probe	48
I.6	Replacing probe preliminary filter	48
I.7	Replacing thermocouple	48
<b>J.</b>	<b>Questions and answers</b>	<b>49</b>
<b>K.</b>	<b>Technical data</b>	<b>50</b>
K.1	Standards and tests	50
K.2	Measuring ranges and accuracies	50
K.3	Other instrument data	52
K.4	EC declaration of conformity	53
K.5	Principles of calculation	53
K.5.1	Fuel parameters	54
K.5.2	Calculation formulae	54
K.6	Recommended rinsing times	57
<b>L.</b>	<b>Accessories/spare parts</b>	<b>58</b>
	<b>Functional overview</b>	<b>60</b>

# A. Safety advice

## Avoid electrical hazards:

- ▶ Never use the measuring instrument and probes to measure on or near live parts!

## Protect the measuring instrument:

- ▶ Never store the measuring instrument/sensors together with solvents (e.g. acetone). Do not use any desiccants.

## Product with **Bluetooth®** (Option)

Changes or modifications, which are not expressly approved by the responsible official body, can lead to a withdrawal of operating permission.

Interference with data transfer can be caused by instruments which transmit on the same ISM band, e.g. microwave ovens, ZigBee

The use of radio connections is not allowed in e.g. aeroplanes and hospitals. For this reason, the following point must be checked before entering:

- ▶ Deactivate Bluetooth function

 → **Inst' settings** → **OK** → **Communication** → **OK** → Select **IrDA** **OK**

## **Product safety/ preserving warranty claims:**

- ▶ Operate the measuring instrument only within the parameters specified in the Technical data.
- ▶ Handle the measuring instrument properly and according to its intended purpose.
- ▶ Never apply force!
- ▶ Temperatures given on probes/sensors relate only to the measuring range of the sensors. Do not expose handles and feed lines to any temperatures in excess of 70 °C unless they are expressly permitted for higher temperatures.
- ▶ Open the measuring instrument only when this is expressly described in the instruction manual for maintenance purposes.
- ▶ Carry out only the maintenance and repair work that is described in the instruction manual. Follow the prescribed steps exactly. For safety reasons, use only original spare parts from Testo.

## 8 A. Safety advice

Any additional work must only be carried out by authorised personnel. Testo will otherwise refuse to accept responsibility for the proper functioning of the measuring instrument after repair and for the validity of certifications.



### **Ensure correct disposal:**

- ▶ Dispose of defective rechargeable batteries and spent batteries at the collection points provided for that purpose.
- ▶ Send the measuring instrument directly to us at the end of its useful life. We will ensure that it is disposed of in an environmentally friendly manner.



## B. Intended purpose

*This chapter describes the areas of application for which the measuring instrument is intended.*

The testo 340 is a handheld measuring instrument used in professional flue gas analysis for:

- Engineers servicing/monitoring industrial combustion plants (process systems, power stations)
- Emissions inspectors
- Engine manufacturers and operators
- Service engineers/mechanics of burner/boiler manufacturers in the industrial sector

Typical measuring tasks and particular characteristics of the testo 340 include:

- Measurement on industrial engines (CO/NO dilution)
- Measurement on gas turbines (high precision CO and NO plus optional dilution)
- Emissions measurement (integrated flow speed and differential pressure measurement)

testo 340 should not be used:

- for continuous measurements > 2 h
- as a safety (alarm) instrument

**!** The testo 340 with the Bluetooth option may only be operated in countries in which it is type approved (see Technical Data).

# C. Product description

*This chapter provides an overview of the individual components of the product.*

## C.1 Measuring instrument

### C.1.1 Overview



① Infrared interface



Do not point infrared beam at people's eyes!

② Interfaces: USB, PS2

③ On/Off switch

④ Condensate trap (on rear)

⑤ Attachment for carrying strap (on rear)

⑥ Magnetic holders (on rear)



Strong magnets

**Damage to other instruments!**

► Keep well away from products which could be damaged through the effects of magnetism (e.g. monitors, computers, heart pacemakers, credit cards).









⑦ Display

⑧ Service cover (on rear)

⑨ Keypad

⑩ Instrument connections: flue gas probe, sensor, pressure probe, mains unit, gas outlet

## C.1.2 Keypad

Key	Functions
	Switch measuring instrument on/off
	Function key (orange, 3x), relevant function is shown on the display
	Scroll up, increase value
	Scroll down, reduce value
	Back, cancel function
	Open <b>Main menu</b> : press briefly (changed settings are stored, measurement values are carried over into the menu <b>Flue gas</b> ); open <b>Measurements</b> menu: press and hold down for 2s (changed settings are stored, measurement values are carried over into the menu <b>Flue gas</b> )
	Open <b>Inst' diagnosis</b> menu
	Change display light: display light stays on permanently or display light is switched on for 10s every time the key is pressed.







## C.1.3 Display

Depending on the menu that is active, the display shows a variety of elements.

### Header (active in all views)



- ① Warning symbol (only if there is a device error; device errors are displayed in the **Inst' diagnosis** menu).
- ② Active folder and location.
- ③ Power supply symbol:

Symbol	Characteristic	Symbol	Characteristic
	Mains operation		Rech. battery operation, capacity: 26-50%
	Rech. battery operation, capacity: 76-100%		Rech. battery operation, capacity: 6-25%
	Rech. battery operation, capacity: 51-75%		Rech. battery operation, capacity: 0-5%

### Function select view

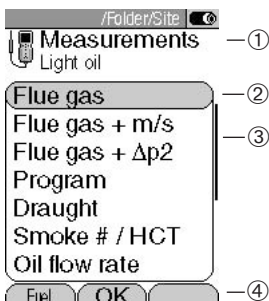

- ① Active menu, activated fuel
- ② Function selection field:  
The selected function has a grey background.  
Unavailable functions are written in grey type
- ③ Scroll bar
- ④ Function keys for entering commands

### Settings view

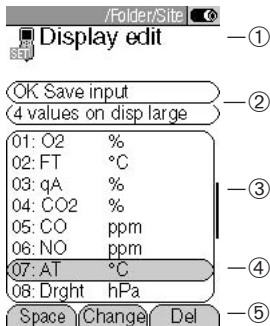

- ① Active menu
- ② Function fields for entering commands
- ③ Scroll bar
- ④ Selection field for adjustable values:  
The selected value is shown with a grey background. Unavailable values are written in grey type.
- ⑤ Function keys for entering commands

### Measuring view

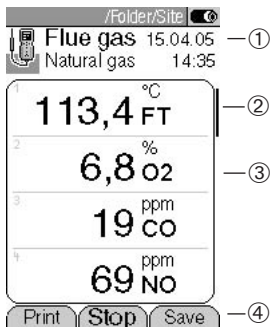

- ① Active menu, depending on the selected function:  
Additional information (e.g. activated fuel, date and time)
- ② Scroll bar
- ③ Display field for readings, parameters
- ④ Function keys for entering commands

## C.1.4 Instrument connections

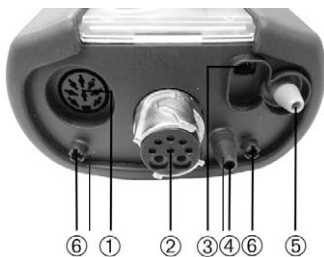

- ① Sensor socket
- ② Flue gas socket
- ③ Mains unit socket
- ④ Pressure socket p+
- ⑤ Pressure socket p-
- ⑥ Gas outlet

## C.1.5 Interfaces



- ① USB interface:  
connection to PC
- ② PS2 interface:  
Adapter for automatic furnaces
- ③ Ir/IrDA interface
- ④ Bluetooth interface

## C.1.6 Components

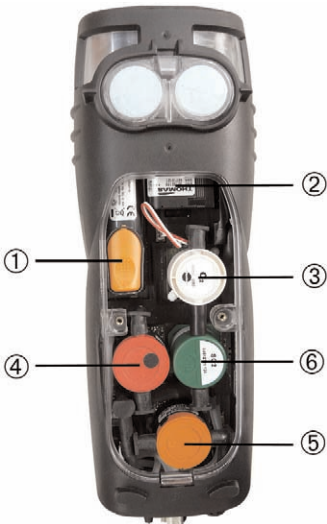

- ① Rechargeable battery
- ② Measuring gas pump
- ③ Sensor slot 1: O<sub>2</sub>
- ④ Sensor slot 2: CO, CO<sub>low</sub>, NO, NO<sub>low</sub>, SO<sub>2</sub>
- ⑤ Sensor slot 3: NO, NO<sub>low</sub>, NO<sub>2</sub>
- ⑥ Sensor slot 4: CO, CO<sub>low</sub>, SO<sub>2</sub>, NO<sub>2</sub>

## C.1.7 Carrying strap

To secure the carrying strap:



- 1 Place the measuring instrument on its front.
- 2 Attach carrying strap in the fixture (①).

## C.2 Modular flue gas probe

Place the  
Abgassonde

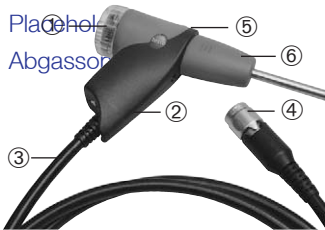

- ① Removable filter chamber with window and particle filter
- ② Probe handle
- ③ Connecting lead
- ④ Connecting plug for measuring instrument
- ⑤ Probe module release
- ⑥ Probe module

# D. Commissioning

*This chapter describes the steps required to commission the product.*

- ▶ Remove the protective film from the display.

The measuring instrument is supplied with a rechargeable battery already fitted.

- ▶ Charge the rechargeable battery up fully before using the measuring instrument (see *Charging batteries*, p. 16).

# E. Operation

*This chapter describes the steps that have to be executed frequently when using the product.*

**!** Please read this chapter carefully. The following chapters of this document will assume you are already familiar with the content of this chapter.

## E.1 Mains unit/rechargeable battery

If the mains unit is connected, the measuring instrument is automatically powered from the mains unit. It is not possible to charge the rechargeable battery in the measuring instrument during operation.

### E.1.1 Changing the battery

**!** The measuring instrument must not be connected to a mains socket via the mains unit. The measuring instrument must be switched off. Change the rechargeable battery within 60 minutes, otherwise instrument settings (e.g. date/time) will be lost.

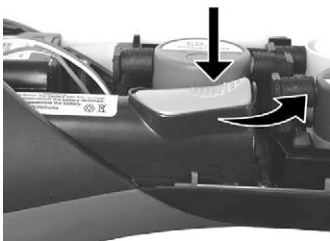

- 1 Place the measuring instrument on its front.
- 2 Loosen screws with a Phillips screwdriver, release clip in the direction of the arrow and remove service cover.
- 3 Open the rechargeable battery compartment: Press the orange key and push in the direction of the arrow.
- 4 Remove the rechargeable battery and insert a new one. Use only Testo 0515 0100 rechargeable batteries!
- 5 Close the rechargeable battery compartment: Press the orange key and push against the direction of the arrow until the rechargeable battery engages.
- 6 Replace and close service cover (clip must click in), fix with screws.

## E.1.2 Charging batteries

The rechargeable battery can only be charged at an ambient temperature of  $\pm 0...+35^{\circ}\text{C}$ . If the rechargeable battery has discharged completely, the charging time at room temperature is approx. 5-6 hrs.

### Charging in the measuring instrument

**!** The measuring instrument must be switched off.

- 1 Connect the plug of the mains unit to the mains unit socket on the measuring instrument.
- 2 Connect the mains plug of the mains unit to a mains socket.
  - The charging process will start. The charge status will be shown on the display. The charging process will stop automatically when the rechargeable battery is fully charged.

### Charging in the charger (0554 1103)

- ▶ Refer to the documentation that comes with the charger.

### Battery care

- ▶ If possible, always discharge the rechargeable battery and recharge it fully.
- ▶ Do not store the battery for long periods when discharged. (The best storage conditions are at 50-80 % charge level and 10-20 °C ambient temperature; charge fully before further use).

## E.1.3 Operation with the mains unit

- 1 Connect the plug of the mains unit to the mains unit socket on the measuring instrument.
- 2 Connect the mains plug of the mains unit to a mains socket.
  - The measuring instrument is powered via the mains unit.
  - If the measuring instrument is switched off and a rechargeable battery is inserted, the charging process will start automatically. Switching the measuring instrument on has the effect of stopping rechargeable battery charging and the measuring instrument is then powered via the mains unit.



## E.2 Probes/sensors

### E.2.1 Connecting probes/sensors

#### ! Sensor socket:

Sensor detection is carried out at the sensor socket during the activation process: Always connect the sensors you need to the measuring instrument before switching it on or switch the device on and then off again after a change of sensor so that the correct sensor data are read into the measuring instrument.

#### Flue gas socket:

Probe/sensor detection at the flue gas socket is carried out continuously. It is possible to change the probe/sensor even while the measuring instrument is switched on.

#### Connecting flue gas probes



- ▶ Plug the connector onto the flue gas socket and lock by turning it clockwise gently (bayonet lock).

- ! There must be no more than two extension leads (0554 1202) between the measuring instrument and the flue gas probe.

#### Connecting other sensors



- ▶ Insert the connector of the sensor into the sensor socket.

#### Connecting the pressure tube

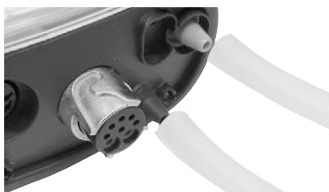

- ▶ Connect the pressure tube/tubes to the connecting nipple/nipples of the pressure socket(s).

## E.2.2 Replacing the probe module

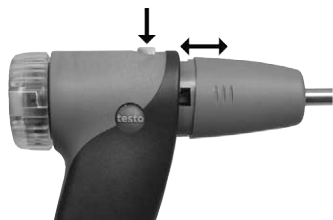

- 1 Press the key on the top of the probe handle and remove the probe module.
- 2 Fit a new probe module and engage it in place.

## E.3 Regular care

### E.3.1 Condensate trap

The fill level of the condensate trap can be read from the markings on the trap. A warning message is displayed if the level in the condensate trap reaches 90% (⚠, red flashing light).

#### Emptying the condensate trap

**!** The condensate consists of a weak mix of acids. Avoid contact with the skin. Make sure that the condensate does not run over the housing.



Caution!

Condensate entering the gas path.

#### Damage to the sensors and flue gas pump!

- ▶ Do not empty the condensate trap while the flue gas pump is in operation.



- 1 Hold the measuring instrument so that the condensate outlet points up.
- 2 Open the condensate outlet of the condensate trap: Push out approx. 7 mm to the stop).
- 3 Let the condensate run out into a sink .
- 4 Mop up any remaining drops on the condensate outlet using a cloth.
- 5 Close the condensate outlet.

**!** The condensate outlet must be completely closed (marking), otherwise measuring errors could occur if external air gets in.

## E.3.2 Checking/replacing the particle filter

### Checking the particle filter:



- ▶ Check the particle filter of the modular flue gas probe for contamination at regular intervals: Check visually by looking through the window of the filter chamber. Replace the filter if there are signs of contamination

### Replacing the particle filter:

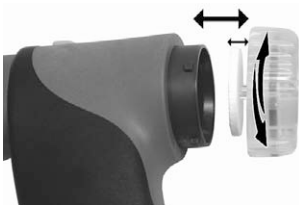

! The filter chamber may contain condensate

- 1 Open the filter chamber by turning it gently anticlockwise.
- 2 Remove the filter plate and replace it with a new one (0554 3385).
- 3 Fit the filter chamber again and close it by turning it gently clockwise.

## E.4 Basic operating steps

### E.4.1 Switching the measuring instrument on

#### ▶

- The start screen is displayed (for about 5 s).
- Display light is switched on for 10 s.

#### Option:

- ▶ To go directly to a measurement while the start screen is being displayed, press the function key for the desired measurement. See also *Start keys edit*, p. 29.

- The **Measurements** menu is opened.

-or-



- If the power supply was interrupted for a longer period: the **Date/Time** menu is opened.

-or-

- There is a device error: The **Error diagnosis** is displayed.

## E.4.2 Calling up the function

! Functions which cannot be selected because the required sensor/probe is not connected are shown in grey type.







- 1 Select function: , .
  - The selected function is shown with a grey background.
- 2 Confirm selection: .
  - The selected function is opened.

## E.4.3 Entering values

Some functions require values (numbers, units, characters) to be entered. Depending on the function that is selected, the values are entered via either a list field or an input editor.





### List field



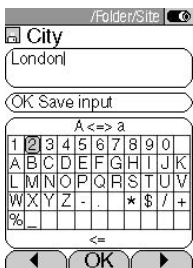



- 1 Select the value to be changed (number, unit): , .
- 2 Adjust the value: , .
- 3 Repeat steps 1 and 2 as required.
- 4 Confirm the input: .
- 5 Save the input: **OK Save input** → .

### Input editor



- 1 Select value (character): , , , .
- 2 Accept the value: .

#### Options:

- ▶ Switch between uppercase/lowercase letters: **A <=> a** (not always available).
- ▶ Delete character: **<=**.
- ▶ To position the cursor in the text: Select the text input field: ,  and position the cursor: , .
  - ▶ To delete character in front of the cursor: .

- 3 Repeat steps 1 and 2 as required.
- 4 Save the input: **OK Save input** → **OK**.

### E.4.4 Printing data

Data are printed out via the function key **Print**. The function is only available if a printout is possible.

If data are to be transferred to a protocol printer via the infrared or Bluetooth interface, the printer that is to be used must be activated, see *Printer*, p. 28.

### E.4.5 Saving data

Data are saved either via the function key **Save** or the function field **OK Save input**. The functions are only available if saving is possible.

See also *Memory*, p. 22.

### E.4.6 Confirming an error message

If an error occurs, an error message is shown in the display.

- ▶ To confirm an error message: **OK**.

Errors which have occurred and have not yet been rectified are shown by a warning symbol in the header (⚠).

Messages for errors which have not yet been rectified can be viewed in the **Error diagnosis** menu, see *Instrument diagnosis*, p. 26.

### E.4.7 Switching the measuring instrument off

! Unsaved readings are lost when the measuring instrument is switched off.

- ▶ .

- Possibly: The pump starts and the sensors are rinsed until the shutoff thresholds ( $O_2 > 20\%$ , other parameters  $< 50\text{ppm}$ ) are reached. Rinsing lasts no more than 2 minutes.
- The measuring instrument switches off.

## E.5 Memory

All readings are allocated to the location that is activated at the time and can be saved in the Flue gas menus. Unsaved readings are lost when the measuring instrument is switched off.

Folders and locations can be created (max. 100 folders, max. 10 locations per folder), edited and activated and measurement protocols can be printed.

The special function **Extras memory** can be used to display the remaining free memory space. All protocols can be printed or deleted. The entire memory (folders and locations incl. protocols) can also be cleared.

### Calling up the function:

 → **Memory** → .

### E.5.1 Folders

#### Creating a new folder:

Folders are given a unique identification via the folder number. A folder number can only be allocated once. The folder number cannot be changed afterwards.

- 1 **New Folder** → .
- 2 Select **Folder Number** → .
- 3 Enter values → **OK Save input** → .
- 4 Repeat steps 2 and 3 for the other criteria as required.
- 5 .

#### Ordering the folders list:

- 1 **Folders list**.
- 2 Select the order criterion: , , .

#### Restoring the folders list:

- ▶ Order the list in the sequence in which the folders were created:  
**Restore list** → .

#### Editing folders:

- ▶ Select the folder.

##### Options:

- ▶ Delete the folder: .
- ▶ Edit the folder: .

## E.5.2 Location

### Creating a new location:

A location is always created in a folder.

- 1 Select the folder →  → **New location** → .
- 2 Select the **Location name** → .
- 3 Enter values → **OK Save input** → .
- 4 Repeat steps 2 and 3 for the other criteria accordingly.
- 5 **OK Go to measurement** or **OK To location** → .

### Ordering the locations list:

- 1 Select the folder → .
- 2 **Locations list** → .

### Activating a location:

- ▶ Select the folder →  → Select location → .
- The location is activated and the **Measurements** menu is opened.

### Restoring the locations list:

- ▶ To arrange the list in the order in which the folders were created:  
Select the folder →  → **Restore list** → .

### Delete a location:

- 1 Select the folder → .
- 2 Select the location → .
- 3 Select **Delete site with data** → .

### Performing location settings:

For flow speed, air flow and mass flow to be measured correctly, the shape and surface area of the cross-section must be set.

The parameters **Pitot factor** and **Offset factor** influence the measurement of flow speed, air flow and mass flow. The pitot factor depends on the type of pitot tube that is used.

The offset factor should be set at 1.00 for all standard applications.

The parameters **Temp./amb.** (ambient air temperature), **Hum/amb.** (ambient air humidity) and **Dew p./amb.** (ambient air dew point) influence calculation of the q<sub>A</sub> (Flue gas loss) and DP (Flue gas dew point temperature). The parameters should be set to the factory settings for all standard applications (Temp./amb.: 20.0 °C, Hum/amb.: 80.0 %, Dew p./amb.: 16.4 °C). To achieve greater accuracy, the values can be adjusted to the actual ambient conditions.

If the ambient air temperature sensor is plugged in, the value for Temp./amb. is accepted automatically. The parameter **Dew p./amb.** can be calculated from the values of **Temp./amb.** and **Hum/amb.** via the function key .

1 Select the folder → .

2 Select the location → .

#### Options:

▶ To set the shape of the cross-section:

**Cross section** →  → Select the cross-section → .

▶ To set the surface area of the cross-section:

**Cross section** →  → Select the cross-section →  → Set the values → .

▶ To set parameters:

Select the parameter →  → Set the values → .

3 **OK To location** → .

## E.5.3 Protocols

### Printing/deleting all protocols:

▶ Select the folder →  → Select a location → .

- The saved protocols are displayed. Protocols of measurement programs are marked with a vertical line and the number of individual measurements (e.g. **I245**), for more than 999 measurements dots are used (**I...**). If automatic furnace data are stored with a measurement protocol the following symbol is displayed next to the protocol name: . The data are printed with the protocol printout.

#### Options:

▶ To print all data: Print all → .

▶ To delete all data: Delete all → .



**Displaying/printing/deleting an individual protocol:**

- 1 Select the folder → **OK** → Select a location → **Data**.
  - The saved protocols are displayed. Protocols of measurement programs are marked with a vertical line and the number of individual measurements (e.g. **I245**), for more than 999 measurements dots are used (**I...**). If automatic furnace data are stored with a measurement protocol the following symbol is displayed next to the protocol name: . The data are printed with the protocol printout.
- 2 Select the protocol → **Value**.

**Options:**

  - ▶ To print the data: **Print**.
  - ▶ To delete the data: **Del**.

## E.5.4 Extras Memory

**Calling up the function:**

- ▶  → **Memory** → **Extra**.
  - The remaining free memory space is displayed.
- Options:**
- ▶ **Print all data** → **OK**.
  - ▶ **Delete all data** → **OK**.
  - ▶ **Delete memory** → **OK**.

## E.6 Instrument diagnosis

Important operating values and instrument data are displayed. A gas path check can be carried out. The status of the sensors and any device errors not yet rectified can be displayed.

### Calling up the function:

▶  → Inst' diagnosis.

-or-

▶ .

### Performing a gas path check:

1 **Gas path check** → .

2 Place the black sealing cap on the tip of the flue gas probe.

- The pump flow is displayed. If the flow rate  $\leq 0.02$  l/min, the gas paths are not leaking.

3 End the check: .

### Viewing device errors:

▶ **Error diagnosis** → .

- Unrectified errors are displayed.

▶ View next/previous error: , .

### Viewing the sensor diagnosis:

1 **Sensor check** → .

- Possibly: Gas zeroing (30 s).

2 Select the sensor: , .

- The status of the sensor is displayed.

## F. Configuration

*This chapter describes the possible steps for adapting the product to the particular measurement task or the requirements of the user.*

**!** Familiarity with the contents of the chapter *Operation* (see p. 15) is assumed.

## F.1 Instrument settings

### F.1.1 Display edit

The parameters/units and the display representation (number of readings displayed per display page) can be set.

Available parameters and units (may vary from one instrument to another):

Display	Parameter	Units
<b>FT</b>	Flue gas temperature	°C, °F
<b>AT</b>	Ambient temperature	°C, °F
<b>CO2</b>	Carbon dioxide	%
<b>O2</b>	Oxygen	%
<b>CO</b>	Carbon monoxide	ppm, %, g/GJ mg/m <sup>3</sup> , mg/kW
<b>uCO</b>	Carbon monoxide undiluted	ppm
<b>NO</b>	Nitrogen monoxide	ppm, %, g/GJ, mg/m <sup>3</sup> , mg/kW
<b>NOx</b>	Nitrogen oxide	ppm, %, g/GJ, mg/m <sup>3</sup> , mg/kW
<b>AT</b>	Ambient temperature	°C, °F
<b>DrghT</b>	Flue draught	mbar, hPa, mmWS, inW, Pa, psi, inHG
<b>S02</b>	Sulfur dioxide	ppm, %, g/GJ mg/m <sup>3</sup> , mg/kW
<b>NO2</b>	Nitrogen dioxide	ppm, %, g/GJ mg/m <sup>3</sup> , mg/kW
<b>Itemp</b>	Instrument temperature	°C, °F
<b>DP</b>	Flue gas dew point temperature	°C, °F
Effn	Effency referred to net calorific value	%
Effg	Effency referred to gross calorific value	%
ratio	Poison index	-
ExAir	Air ratio	%

Display	Parameter	Units
<b>ΔP2</b>	Differential pressure (200hPa)	mbar, hPa, Pa mmWS, inW psi, inHG
<b>Gasfl</b>	Gas flow rate	m <sup>3</sup> /h, l/min
<b>GasP</b>	Gas burner output	kW
<b>OilFI</b>	Oil flow rate	kg/h
<b>Oil p</b>	Oil pressure	bar
<b>OilP</b>	Oil burner output	kW
<b>Pabs</b>	Absolute pressure	hPa, mbar, Pa, mmWS, inW psi, inHG
<b>Pump</b>	Pump output	l/min
<b>ΔP1</b>	Differential pressure (40hPa)	mbar, hPa, Pa mmWS, inW psi, inHG
<b>Speed</b>	Flow speed	m/s, fpm
<b>Flow</b>	Airflow	m <sup>3</sup> /s, m <sup>3</sup> /m, m <sup>3</sup> /h, m <sup>3</sup> /d, m <sup>3</sup> /y, f <sup>3</sup> /s, f <sup>3</sup> /m, f <sup>3</sup> /h, f <sup>3</sup> /d, f <sup>3</sup> /y, l/min
<b>MCO, MNOx, MSO2</b>	Mass flow	kg/h, kg/d, t/d, t/y, lb/h
<b>H2</b>	Hydrogen	ppm

**Calling up the function:**

- ▶  → **Inst' settings** →  → **Display edit** → .

**Setting the display representation:**

- ▶ Select **4 values on disp large** or **8 values on disp small** → .

**Changing parameters and units:**

- 1 Select the display position.

**Options:**

- ▶ To insert a space: .
  - ▶ To delete a parameter: .
- 2  → Select parameter →  → Select unit → .

**Saving settings:**

- ▶ **OK Save input** → .

## F.1.2 Printer

The headers (lines 1-3) and the footer for the printout can be set. The printer that is used can be activated.

**Calling up the function:**

- ▶  → **Inst' settings** →  → **Printer** → .

**Setting the print text:**

- 1 **Print text** → .
- 2 Select **Line 1**, **Line 2**, **Line 3** or **Footnote** → .
- 3 Enter the values → **OK Save input** → .
- 4 Repeat steps 2 and 3 for the other lines in the same way.
- 5 **OK Save input** → .

**Printer selection:**

! The printer 0554 0543 can only be selected after activating bluetooth, see *Communication*, p. 30.

- ▶ **Select Printer** →  → Select Printer → .

## F.1.3 Start keys edit

The assignment of the function keys depends on the function that is selected. Only the function keys in the start screen (shown when the measuring instrument is switched on) can be assigned any function from the **Measurements** menu.

The function keys are only active if the required sensors are connected.

### Calling up the function:

▶  → **Inst' settings** → **OK** → **Start keys edit** → **OK**.

### Assigning functions to the start keys:

- 1 Select function → Press the function key that is to be assigned the selected function.
- 2 Repeat step 1 for the other function keys as required.

### Saving settings:

▶ **OK Save input** → **OK**.

## F.1.4 AutoOff

With the AutoOff function active, the instrument switches itself off automatically if no key is pressed after the set period of time.

### Calling up the function:

▶  → **Inst' settings** → **OK** → **AutoOff** → **OK**.

### Switching AutoOff on and off:

▶ Select **Auto Off** → **Change** → select **On** or **Off** → **OK**.

### Setting the AutoOff time:

▶ Select **Time** → **Change** → Set the value → **OK**.

## F.1.5 Communication

Select interface IR/IrDA/ interface Bluetooth.

Calling up the function:

- ▶  → **Inst' settings** →  → **Communication** →

Set interface IR/IrDA / interfaceBluetooth:

- ▶ Select **IrDA** oder **Bluetooth** →

## F.1.6 Date/Time

The date and the time can be set.

Calling up the function:

- ▶  → **Inst' settings** →  → **Date/Time** →

Setting the date/time:

- ▶ Select **Time** or **Date** →  → Set the values → .

Saving settings:

- ▶ **OK Save input** → .

## F.1.7 Language

The menu language can be set.

Calling up the function:

- ▶  → **GeräteEinst.** →  → **Sprache** → .

-or-

- ▶  → **Inst' settings** →  → **Language** → .

Setting the language:

- ▶ Select **Deutsch** or **Englisch** → .

-or-

- ▶ Select **German** or **English** → .

## F.2 Sensor settings

It is possible to set an NO<sub>2</sub> addition and thresholds for activating sensor protection (dilution/disconnect). The actual calibration data and the status of the sensors can be displayed. Recalibration can be carried out.

### Calling up the function:

►  → **Sensor settings** → **OK**.

### Setting the NO<sub>2</sub> addition (as long as no NO<sub>2</sub> sensor is plugged in):

#### 1 NO<sub>2</sub> addition.

##### Option:

► Reset NO<sub>2</sub> addition to default value: **Deflt**.

2 **Change** → Set the value → **OK**.

### Schematic presentation of gas path testo 340:

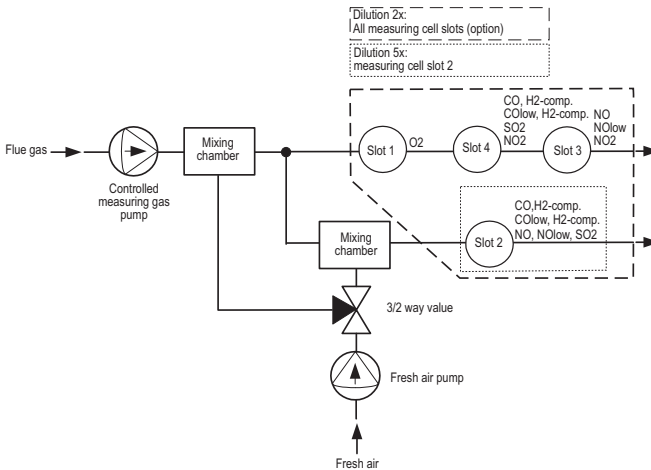

Slot 1	Slot 2	Slot 3	Slot 4
O <sub>2</sub>	CO, H <sub>2</sub> -comp.	NO	CO, H <sub>2</sub> -comp.
	CO <sub>low</sub> , H <sub>2</sub> -comp.	NO <sub>low</sub>	CO <sub>low</sub> , H <sub>2</sub> -comp.
	NO	NO <sub>2</sub>	SO <sub>2</sub>
	NO <sub>low</sub>		NO <sub>2</sub>
	SO <sub>2</sub>		

**Setting sensor protection:**

To extend the measuring range and protect the sensors against overloads, you can set thresholds which, when exceeded, activate sensor protection. Thresholds for a variety of parameters can be set, depending on the sensors that are connected.

For instruments without "Dilution of all sensors" option: If a threshold of the sensor in slot 2 is exceeded, the gas to sensor 2 is diluted by a factor of five.

There is switch-off if a sensor threshold value is exceeded in slot 3 or slot 4.

For devices with the "Dilute all sensors" option: If a sensor threshold value is exceeded in slot 2, the gas to sensor 2 is diluted by factor five. If a sensor threshold value is exceeded in slot 3 or slot 4, gas to all sensors is diluted by factor two.

With dilution active, the reading resolution and accuracies will change, see Technical data. Diluted values are represented inversely.

If the threshold is still exceeded despite dilution, the instrument is switched off. To deactivate sensor protection, set the thresholds to 0 ppm.

**1 Sensor protection** → .

**2** Select the parameter.

**Option:**

▶ Reset selected parameter to default value: .

**3 Change** → Set the values → .

**4** Repeat steps **2** and **3** for the other parameters accordingly.

▶ Saving settings: **OK Save input** → .

Measurement CO (H<sub>2</sub>-compensated) sensor:

**!** In order to protect the sensor and for a longer sensor life, we recommend that in measurements with unexpectedly high CO concentrations (more than 1,000ppm), the CO sensor is installed in slot 2, and that the threshold of the CO sensor protection is set to 1,000ppm. From a CO concentration of 1,000ppm, dilution with a factor of 5 is automatically activated.

This setting can also be made if H<sub>2</sub> concentrations of more than 1,000ppm are to be expected.



### Display ppm/hour counter (active only when sensors with exchangeable filters are used):

For those sensors which have an exchangeable chemical filter for neutralizing cross-gases, a ppm/hour counter is available.

this applies to:

CO, H2 comp. sensor (filter life approx. 170000 ppmh)

NO sensor (filter life approx. 120000 ppmh)

1 **ppm/hour counter** → .

2 Select sensors.

#### Options:

- ▶ Switch between the individual sensors: , .
- ▶ Display of max. filter life and current hour counter value
- ▶ When maximum filter life is reached, information is displayed: **Filter material spent. Please exchange filter.**
- ▶ Reset hour counter of a sensor: .

### Displaying actual calibration data/sensor status:

▶ **Calibrationdata** → .

#### Options:

- ▶ To change between the actual calibration data of the individual sensors: , .
- ▶ To print out the actual calibration data of all sensors: .
- ▶ To display the status of the sensor as a graphic: .
  - The status of the sensor is checked on every recalibration. Any deviation from the condition on delivery is indicated as a percentage.  
70%-threshold: "Gas cell reading unstable, replace item recommended."  
50%-threshold: "Replacement sensor."  
The last 25 recalibrations are shown.
- ▶ To return to the display of the actual calibration data: .

### Recalibration:

CO, H2-comp, SO2, NO2, NO sensors and the O2 reference value can be recalibrated. Measurement gas dilution in slot 2 can be recalibrated.

If obviously unrealistic readings are displayed, the sensors should be checked and recalibrated as required.



Dangerous gases

### Danger of poisoning!

- ▶ Observe safety regulations/accident prevention regulations when handling test gases.
- ▶ Use test gases in well ventilated rooms only.

**!** Recalibration with low gas concentrations can lead to deviations in accuracy in the upper measuring ranges.

Sensor protection is deactivated during recalibration. For this reason, test gas concentration should be lower than the maximum value of the sensors.

Recalibrating the sensor at slot 2 has an effect on the dilution: Always carry out a recalibration of measurement parameters before a recalibration of dilution.

The following conditions must be met when recalibrating:

- Use absorption-free tube material
- Switch the measuring instrument on at least 20 min before recalibration (warming-up)
- Use clean air for gas zeroing
- Charge the test gas via calibration adapter (0554 1205, recommended) or the tip of the probe
- Maximum overpressure of the test gas: 30 hPa (recommended: unpressurised via bypass)
- Charge the test gas for at least 3 min

Recommended test gas concentrations and compositions are given in Testo's field guide to test gases.

**1 Recalibration** → .

- Possibly: Gas zeroing (30 s).

**2** Select the parameter →  → Enter the test gas concentration (nominal value).

**3** Charge the analyzer with test gas.

**4** Start calibration: .

If the parameter of the sensor inserted in slot 2 has been selected:

- You will receive a query as to whether dilution should be initialised.

▶ Start recalibration of parameter:  → .

▶ Start recalibration of dilution:  → .

**5** Accept the nominal value as soon as the actual value is stable: .

## F.3 Fuels

The fuel can be selected. The fuel-specific coefficients can be set. Ten fuels can be set for each customer.

### Calling up the function:

▶  → Fuels → .

### Activating fuel:

▶ Select the fuel → .

### Setting coefficients:

1 .

#### Option:

- ▶ To reset all coefficients to default values: **Default values** → .
- ▶ To change the name of the fuel (only possible with customer-specific fuel): **Name** →  → Set the values → .

2 Select the coefficient

#### Option:

- ▶ To reset the chosen coefficients to default values: .

3  → Set the values → .

4 **OK Save input** → .

**!** The calculation of the fuel factors is carried out via the testo easyEmission software.

# G. Measuring

*This chapter describes the measuring tasks that can be carried out with the product.*

**!** Familiarity with the contents of the chapter *Operation* (see p. 15) is assumed.

## G.1 Preparing measurements

### G.1.1 Zeroing phases

#### Measuring the ambient air temperature (AT)

If no ambient air temperature sensor is connected, the temperature measured by the thermocouple of the flue gas probe during the zeroing phase is used as the ambient air temperature. All dependent parameters are calculated by this value. This method of measuring ambient air temperature is sufficient for systems dependent on ambient air. However, the flue gas probe must be near the intake duct of the burner during the zeroing phase!

If an ambient air temperature sensor is connected, the ambient air temperature is measured continuously via this sensor.

#### Gas zeroing

The first time a gas measuring function is called up after the instrument has been switched on, the sensors are zeroed.

**!** The flue gas probe may already be in the flue gas duct during zeroing if a separate AT sensor is connected.

#### Draught/pressure zeroing

The pressure sensors are zeroed when a pressure measuring function is called up.

**!** The pressure sockets of the instrument must be free (i.e. unpressurized, not closed) during zeroing.

## G.1.2 Using the modular flue gas probe

### Checking the thermocouple



The thermocouple of the flue gas probe must not lie against the probe cage.

- ▶ Check before use. Bend the thermocouple back if necessary.

### Aligning the flue gas probe



The flue gas must be able to flow freely past the thermocouple.

- ▶ Align the probe by turning it as required.

The tip of the probe must be in the centre of the flue gas flow.

- ▶ Align the flue gas probe in the flue gas duct so that the tip is in the centre of the flow (area of the highest flue gas temperature).

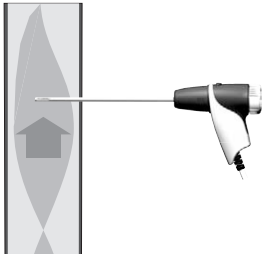

## G.1.3 Configuring the reading display

Only those parameters and units which are activated in the reading display appear in the reading display, the saved measurement protocols and the protocol printouts.

- ▶ Before beginning measurements, configure the reading display so that the required parameters and units are activated, see *Display edit*, p. 27.

## G.1.4 Set location/fuel

Before carrying out measurements, the measurement location and the fuel must be correctly selected see *Memory*, p. 22 and *Fuels*, p. 35.

## G.2 Measurements

### G.2.1 Flue gas, Flue gas + m/s, Flue gas + $\Delta p_2$

The flue gas menus are the central measurement menus in which - in addition to the readings measured with this function - the readings of all measurements carried out are displayed (if this is selected in the **Display edit** menu). All readings can also be saved in or printed out from these menus.

The flue gas menus are always available, regardless of which sensors are connected.

Measuring functions of the three flue gas menus:

- The **Flue gas** function enables flue gas to be measured.
- The **Flue gas + m/s** function enables flue gas to be measured in addition to flow speed (+ air/mass flow calculation) by means of a Pitot tube (the connection cable for the straight Pitot tube thermocouple should not be connected to the instrument probe socket).
- The **Flue gas +  $\Delta p_2$**  function enables flue gas to be measured in addition to differential pressure measurement.

! After measurements with high concentrations and longer measurements, the instrument should be rinsed with fresh air in order to enable the sensors to regenerate, see Chapter Recommended rinsing times, p. 57.

! For flow speed measurement. Before beginning measurement, configure the location settings (Pitot tube factor and correction factor), see chapter *Location*, p. 23.

Do not measure for longer than 5 min, as the drift of the pressure sensor means that the readings could be outside the tolerance limits.

#### Calling up the function:

▶  → **Measurements** →  → **Flue gas** → .

-or-

▶  → **Measurements** →  → **Flue gas + m/s** → .

-or-

▶  → **Measurements** →  → **Flue gas +  $\Delta p_2$**  → .

- Possibly: gas zeroing (32 s).

For the functions **Flue gas + m/s** and **Flue gas +  $\Delta p_2$** :

- ▶ Depressurise the pressure sensor and carry out pressure zeroing with .

**If no fuel has yet been selected:**

- ▶ Select the fuel → .

**Measuring:**

1 Start measuring: **Start**.

- The readings are displayed.

**Option:**

▶ Interrupt measurement and rinse sensors: **Air**,  
Continue measurement: **Gas**.

2 Stop measuring: **Stop**.

**Options:**

▶ To print readings: **Print**.  
▶ To save readings: **Save**.

- The readings from the flue gas measurement, as well as any readings taken over into the menu **Flue Gas** from other measurement functions are stored and/or printed in a measurement protocol (automatic furnace data are not printed).

## G.2.2 Program

Five flue gas measuring programs can be set, saved and run.

**Calling up the function:**

▶  → **Measurements** → **OK** → **Program** → **OK**.

**Changing a measuring program:**

1 Select the program → **Change**.

2 **Meas rate** → **Change** → Enter the values → **OK**.

3 Repeat step 2 for the other criteria accordingly.

4 **OK Save input** → **OK**.

**Running a measuring program:**

1 Select the program → **Start**.

2 Select **Start without zeroing** (only available if gas zeroing has already been carried out) or **Start with zeroing** and start the program with **OK**.

- If selected: Gas zeroing (32 s).

- Stabilisation phase (60 s).

- The program will run and then stop after the programmed time.

**Option:**

▶ To print readings: **Print**.

▶ To cancel the program: **Stop**, start again: **Start**.

## G.2.3 Draught

The **Draught** function is only available when a flue gas probe is connected.

**!** Do not measure for longer than 5 min, as the drift of the pressure sensor means that the readings could be outside the tolerance limits.

### Calling up the function:

▶  → **Measurements** → **OK** → **Draught** → **OK**.

### Measuring:

- 1 Start measuring: **Start**.
  - Draught zeroing (5 s).
- 2 Position the flue gas probe in the centre of the flow (area of the highest flue gas temperature). The display showing the maximum measured flue gas temperature (FT) helps when positioning the probe.
  - The reading is displayed.
- 3 Stop measuring **Stop**.
  - The reading is recorded.

### Option:

- ▶ To print the reading: **Print**.
- 4 To copy the reading to the **Flue gas** menu: **OK**.
    - The **Measurements** menu is opened.

## G.2.4 Smoke#/HCT

### Calling up the function:

▶  → **Measurements** → **OK** → **Smoke#/HCT** → **OK**.

### Recording smoke tester no./smoke numbers/oil derivative with the smoke pump and manual input:

The function is only available if the chosen fuel is an oil.

- 1 **Sm. tester no.** → **Change** → Enter the tester number → **OK**.
- 2 **Smoke # 1** → **Change** → Enter the value → **OK**.
- 3 Repeat step 2 for the other smoke # and the oil derivative accordingly.



### Recording smoke tester no./smoke numbers/oil derivative with the smoke tester testo 308 and wireless transfer:

- t308 must be in Data Mode ( **Data** ).
- 1 Press function key **t308** .
- The values recorded by the smoke tester are transferred.
- 2 Once all values have been transferred, select function key **OK** .

### Entering the heat carrier temperature:

- ▶ **Heat carrier** → **Change** → Enter the value → **OK** .

### Copying values to the Flue gas menu:

! The values are not shown on the instrument's display. In the menu **Flue Gas**, they can be stored and/or printed in a measurement protocol together with the readings from a flue gas measurement, or transferred to a PC

- ▶ **OK Copy readings** → **OK** .
- The **Measurements** menu is opened.

## G.2.5 Gas flow rate

The **Gas flow rate** function is only available if the activated fuel is a gas.

### Calling up the function:

- ▶ **Measurements** → **OK** → **Gas flow rate** → **OK** .

### Measuring:

- 1 Enter the measurement period: **Sample time** → **Change** → Enter the value (**18, 36, or 180** seconds) → **OK** .
- 2 Start measuring: **Start** . Note the counter status of the gas counter.
  - The remaining measurement period is displayed.
  - When the measurement period has lapsed, a long beep is emitted. The last 5 s are indicated by a short beep.
- 3 Enter the flow rate: **Gasflow** → Enter the value → **OK** .
  - The calculated gas burner output is displayed.
- 4 Copy the values to the **Flue gas** menu: **OK Copy readings** → **OK** .
  - The **Measurements** menu is opened.

## G.2.6 Oil flow rate

The **Oil flow rate** function is only available if the activated fuel is an oil.

### Calling up the function:

▶  → **Measurements** → **OK** → **Oil flow rate** → **OK**.

### Measuring:

- 1 Enter the flow rate: **Flowrate** → **Change** → Enter the value → **OK**.
- 2 Enter the oil pressure: **Oil pressure** → **Change** → Enter the value → **OK**.
  - The calculated oil burner output is displayed.
- 3 Copy the values to the **Flue gas** menu: **OK Copy readings** → **OK**.
  - The **Measurements** menu is opened.

## G.2.7 m/s

! A Pitot tube must be connected, the connection cable for the Pitot tube thermo-couple must be connected to the instrument probe socket.

To measure flow speed, air flow and mass flow the parameters of cross-section shape, cross-section surface area, Pitot factor and offset factor must be set, see *Location*, p. 23.

! Do not measure for longer than 5 min, as the drift of the pressure sensor means that the readings could be outside the tolerance limits.

### Calling up the function:

▶  → **Measurements** → **OK** → **m/s** → **OK**.

### Measuring:

- 1 Start measuring: **Start**.
  - Pressure zeroing (5 s).
- 2 Position the Pitot tube in the duct. The display showing the measured flow speed (Speed) helps when positioning the probe.
  - The reading is displayed.
- 3 Stop measuring: **Stop**.
  - The reading is recorded.

### Option:

- ▶ To print the reading: **Print**.
- 4 Accept the reading: **OK**.
    - The **Measurements** menu is opened.

## G.2.8 $\Delta p_2$

**!** Do not measure for longer than 5 min, as the drift of the pressure sensor means that the readings could be outside the tolerance limits.

When measuring the gas flow pressure of gas heaters:



Dangerous mixture of gases

### Danger of explosion!

- ▶ Make sure there are no leaks between the sampling point and the measuring instrument.
- ▶ Do not smoke or use naked flames during measurement.

### Calling up a function:

▶  → **Measurements** → **OK** →  $\Delta p_2$  → **OK**.

### Measuring:

- 1 Start measuring: **Start**.
  - Pressure zeroing (5 s).
- 2 Position the Pitot tube in the duct.
- 3 Stop measuring **Stop**.
  - The reading is recorded.

### Option:

- ▶ To print the reading: **Print**.
- 4 Accept the reading: **OK**.
    - The **Measurements** menu is opened.

## G.2.9 Burner control

With the help of the readout adapter for automatic furnaces (0554 1206), status data and malfunction reports can be read out from compatible automatic furnaces, see also documentation for readout adapter. The range of data which can be read out is dependent on the automatic furnace type.

### Calling up the function:

- 1 Connect readout adapter to the instrument (PS2 interface) and the automatic furnace (use adapter ring if necessary).
- 2  → **Measurements** → **OK** → **Burner Control**.

### Option:

- ▶ Display type and version of the adapter: **Adapt.**













## 44 G. Measuring

3 .

- The data are read from the automatic furnace. An update of the data takes place every 30s at the latest, this is dependent on the automatic furnace.

### Reading out current status data:

The current data are displayed when a connection to the automatic furnace exists. The following data are displayed with the help of symbols:

Component	Status ON	Status OFF	Component	Status ON	Status OFF
Air controller			Flame		Symbol not displayed
Motor			Ignition		
Valve1			Oil prewarmer		
Valve 2					

### Printing data:

▶ .

### Display identification data:

▶ **Info** → .

### Display failure statistic:

▶ **Failure statistic** → .

### Reading out failure store:

Automatic furnaces are equipped with circular buffer memories, i.e. failure reports are overwritten when the failure store is full.. The last failure occurring is at position 1 in the failure list.

▶ .

#### Option:

▶ Scroll through failure list: , .

### Taking readings over into the menu Flue Gas:

! The readings are not presented in the display, in the menu **Flue Gas** they can be stored with the readings from a flue gas measurement, stored in a measurement protocol or transferred to a PC.

For taking data over into the menu **Flue Gas** the function fields **Info** and **Failure statistic** must not be active (grey background).

▶ .

- The Menu **Measurements** is opened.

---

# H. Transferring data

## H.1 Protocol printer

If data are to be transferred to a Testo protocol printer via the infrared or Bluetooth interface, the printer that is to be used must be activated, see *Printer*, p. 28.

Data are printed out via the function key . The function is only available if a printout is possible.

# I. Care and maintenance

This chapter describes the steps and action required in order to keep the product functioning properly.

See also *Regular care*, p. 18.

## I.1 Cleaning the measuring instrument

- ▶ If the housing of the instrument is dirty, clean it with a damp cloth. Do not use any aggressive cleaning agents or solvents. Weak household cleaning agents and soap suds may be used.

## I.2 Replacing sensors

A slot bridge (0192 1552) must be inserted in slots which do not have a sensor. Used sensors must be disposed of as special waste!

The measuring instrument must be switched off and the mains unit disconnected from the mains supply.

- 1 Place the measuring instrument on its front.
- 2 Loosen screws with a screwdriver, release clip in the direction of the arrow, and remove service cover.
- 3 Pull tube connections from the faulty sensor/bridge.
- 4 Remove the faulty sensor/bridge from the slot.

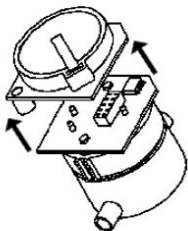

- ! Do not remove auxiliary circuit boards of the new sensors until immediately before installation. Do not leave the sensors without a auxiliary circuit boards for longer than 15 min.
- ▶ NO/NO<sub>low</sub> sensors:  
Remove the auxiliary circuit board.
- 5 Insert a new sensor/bridge in the slot.
- 6 Attach tube connections to the sensor/bridge.
- 7 Replace and close service cover (clip must click in), fix with screws.

- !** After replacing an O<sub>2</sub> sensor, wait 60 min before using the instrument again.  
**!** If retrofitting a sensor you must activate the relevant measuring parameter and unit, see *Display edit*, p. 27.

## I.3 Filter for CO, H<sub>2</sub>-comp., NO exchanging sensors

The measuring instrument must be switched off and the mains unit disconnected from the mains supply.

- 1 Place measuring instrument on its face.
- 2 Loosen screws with a screwdriver, release clip in the direction of the arrow, and remove service cover.
- 3 Remove hose connections from sensor.
- 4 Remove sensor from slot.

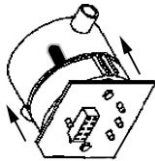

- 5 Remove spent filter from sensor.
- 6 Place new filter on sensor.
- !** Avoid touching the electronics of the sensor.
- !** Observe the markings on the filter and the sensor
- 7 Insert sensor into slot.
- 8 Replace hose connections on to sensor.
- 9 Replace and close service cover (clip must click in), fix with screws.
- 10 Reset ppm hour counter (see *Display ppm/hour counter*, p. 33).

## I.4 Recalibrating sensors

See *Sensor settings*, p. 31.

## I.5 Cleaning the modular flue gas probe

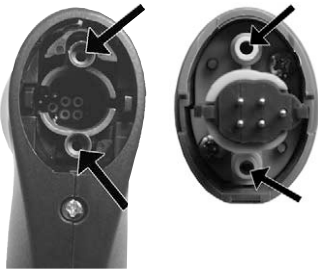

**!** Detach the flue gas probe from the measuring instrument before cleaning.

1 Release the probe catch by pressing the key on the probe handle and remove the probe module.

▶ Probe shafts with preliminary filter:  
Unscrew the preliminary filter.

2 Blow compressed air through the flue ducts of the probe module and probe handle (see illustration). Do not use a brush!

▶ Probe shafts with preliminary filter:

Blow compressed air through the preliminary filter. For thorough cleaning, use an ultrasonic bath or a cleaner for dentures. Screw the preliminary filter back on to the probe shaft after cleaning.

3 Fit a new probe module on the handle and engage it in place.

## I.6 Replacing probe preliminary filter

The preliminary filter in probe modules fitted with a preliminary filter can be replaced.

▶ Unscrew the preliminary filter from the probe shaft and screw on a new filter.

## I.7 Replacing thermocouple

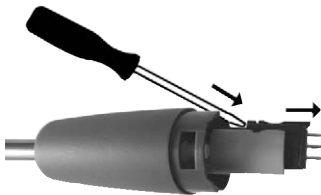

1 Release the probe catch by pressing the key on the probe handle and remove the probe module.

2 Detach the plug-in head of the thermocouple from its mounting using a screwdriver and pull the thermocouple from the probe shaft.

3 Lead a new thermocouple into the probe shaft until the plug-in head engages.

4 Fit probe module on the handle and engage it in place.



# J. Questions and answers

*This chapter gives answers to frequently asked questions.*

Question	Possible causes	Remedy
Measuring instrument keeps switching itself off <b>or</b> instrument will not switch on.	AutoOff function is switched on. Battery spent.	<ul style="list-style-type: none"> <li>▶ Switch AutoOff function off (see <i>AutoOff</i>, p. 29).</li> <li>▶ Charge rech. battery or connect mains unit (see <i>Operation</i>, p. 15).</li> </ul>
Measuring instrument will not switch on.	Battery spent.	<ul style="list-style-type: none"> <li>▶ Charge rech. battery or connect mains unit (see <i>Operation</i>, p. 15).</li> </ul>
Display of the battery capacity appears faulty	Battery was often not fully discharged/charged.	<ul style="list-style-type: none"> <li>▶ Discharge rechargeable battery fully (until instrument switches off by itself) and then charge fully.</li> </ul>
Failure report: <b>Pump flow rate to high</b>	Gas output closed.	<ul style="list-style-type: none"> <li>▶ Ensure that gas output is free</li> </ul>
Message: <b>Gas cell shutdown-threshold has been exceeded</b>	The shutdown threshold of a sensor has been exceeded	<ul style="list-style-type: none"> <li>▶ Remove probe from flue.</li> </ul>
Failure report: <b>Printing not possible</b>	<ul style="list-style-type: none"> <li>· With printer 0554 0543: The wrong interface is activated.</li> <li>· The wrong printer is activated.</li> <li>· Printer is switched off.</li> <li>· Printer is out of wireless range.</li> </ul>	<ul style="list-style-type: none"> <li>▶ Activate correct interface (see <i>Communication</i>, p. 30).</li> <li>▶ Activate correct printer (see <i>Printer</i>, p. 28).</li> <li>▶ Switch printer on.</li> <li>▶ Place printer within wireless range.</li> </ul>

If we could not answer your question, please contact your dealer or Testo Customer Service. For contact data, see back of this document or web page [www.testo.com/service-contact](http://www.testo.com/service-contact)

# K. Technical data

## K.1 Standards and tests

- As declared in the certificate of conformity, this product complies with Directive 2004/108/EEC.
- This product is TÜV approved to EN50379 part 2, exception: SO<sub>2</sub> and NO<sub>2</sub> parameters are not tested, recalibration is not blocked.

## K.2 Measuring ranges and accuracies

Parameter	Measuring range	Accuracy	Resolution	t <sub>90</sub> <sup>1</sup>
O <sub>2</sub>	0...25Vol.%	±0.2Vol.%	0.01Vol.%	< 20s
CO, H <sub>2</sub> -comp.	0...10000ppm	±10ppm or ±10% of reading <sup>1</sup> at 0...200ppm ±20ppm or ±5% of reading <sup>1</sup> at 201...2000ppm ±10% of reading at 2001...10000ppm	1ppm	< 40s
COlow, H <sub>2</sub> -comp.	0...500ppm	±2ppm at 0.0...39.9ppm ±5% of reading at 40.0...500ppm	0.1ppm	< 40s
NO <sub>2</sub>	0...500ppm	±10ppm at 0...199ppm ±5% of reading in rest of range	0.1ppm	< 40s
SO <sub>2</sub>	0...5000ppm	±10ppm at 0...99ppm ±10% of reading in rest of range	1ppm	< 40s
NOlow	0...300ppm	±2ppm at 0.0...39.9ppm ±5% of reading at 40.0...300.0ppm	0.1ppm	< 30s
NO	0...3000ppm	±5ppm at 0...99ppm ±5% of reading at 100...1999ppm ±10% of reading at 2000...3000ppm	1ppm	< 30s
Draught, Δp <sub>1</sub>	-40...40hPa	+ 1.5% v. Mw. at -40.00...-3.00hPa + 0.03hPa at -2.99...2.99hPa + 1.5% v. Mw. at 3.00...40.00hPa	0.01hPa	-
Δp <sub>2</sub>	-200...200hPa	±1.5% of reading at -200.0...-50.0hPa ±0.5hPa at -49.9...49.9hPa ±1.5% of reading at 50.0...200.0hPa	0.1hPa	-

<sup>1</sup> Response time 90%, recommended minimum measurement duration to guarantee correct readings: 3min

Parameter	Measuring range	Accuracy	Resolution	t90 <sup>1</sup>
Pabs	600...1150hPa	±10hPa	1hPa	-
Temperature (NiCrNi)	-40...1200°C	±0.5°C at 0.0...99°C ±0.5% of reading in rest of range	0.1°C at -40.0...999.9°C 0.1°C at 1000°C...1200°C	depends on probe
Efficiency	0...120%	-	0.1%	-
Flue gas loss	0...99,9%	-	0,1%	-
Flue gas dewpoint	0...99,9°C	-	0.1%	-
CO2 determination (Calculated from O2)	0...CO2 max.	±0.2 Vol%	0.1 Vol%	<40s

<sup>1</sup> Response time 90%, recommended minimum measurement duration to guarantee correct readings: 3min

For activated single dilution slot 2 (factor 5)

Parameter	Measuring range	Accuracy	Resolution
CO, H2-comp.	700...50000ppm	+10% of reading (additional error)	1ppm
COlow, H2-comp.	300...2500ppm	+10% of reading (additional error)	0.1ppm
SO2	500...25000ppm	+10% of reading (additional error)	1ppm
NO	500...15000ppm	+10% of reading (additional error)	1ppm
NOlow	150...1500ppm	+10% of reading (additional error)	0.1ppm

With activated dilution of all sensors (optional) (factor 2)

Parameter	Measuring range	Accuracy	Resolution	t90 <sup>1</sup>
O2	0...25Vol.%	±1Vol.% of reading additional error (0...4,99Vol.%) ±0,5Vol.% of reading additional error(5...25Vol.%)	0.01Vol. %	< 20s
CO, H2-comp.	700...20000ppm	+10% of reading (additional error)	1ppm	
COlow, H2-comp.	300...1000ppm	+10% of reading (additional error)	0.1ppm	
NO2	200...1000ppm	+10% of reading (additional error)	0.1ppm	
SO2	500...10000ppm	+10% of reading (additional error)	1ppm	
NOlow	150...600ppm	+10% of reading (additional error)	0.1ppm	
NO	500...6000ppm	+10% of reading (additional error)	1ppm	

<sup>1</sup> Response time 90%, recommended minimum measurement duration to guarantee correct readings: 3min

Filter lifetime

Parameter	Lifetime
CO, H2-comp.	170000 ppmh
NO	120000 ppmh

## K.3 Other instrument data

Characteristic	Values
Operating temperature	-5...50 °C
Storage/transport temperature	-20...50 °C
Power supply	Battery block: 3.7V/2.4 Ah Mains unit: 6.3 V/2 A
Dimensions (L x W x H)	283 x 103 x 65mm
Weight	960g
Memory	max. 100 folders, max. 10 locations per folder
Display	Monochrome, 4 grey levels, 160 x 240 pixels
Battery storage temperature:	±0...35 °C
Battery life	>6 h (pump on, display light off, 20 °C ambient temperature)
Battery charge time	approx. 5-6h
Pump perform.against x hPa	Max. positive pressure at probe tip: + 50 mbar Max. negative pressure at probe tip: -200 mbar
Initialization and zeroing time	30 sec.
Protection class	IP 40
Guarantee	Measuring instrument: 24 months Sensors: 12 months, O2 sensor: 18 months Flue gas probe: 24 months Thermocouple: 12 months Battery: 12 months Warranty conditions: see <a href="http://www.testo.com/warranty">www.testo.com/warranty</a>
Option Bluetooth®	Typ-designation: BlueNiceCom IV Bluetooth Qualified Product Notice: BNC4_HW2x_SW2xx Bluetooth listing identifier: B013784 Bluetooth listing company: 10274
 Bluetooth	
Option Bluetooth®	Range <10m
Option Bluetooth®	<b>EU countries</b>
Certification	Belgium (BE), Bulgaria (BG), Denmark (DK), Germany (DE), Estonia (EE), Finland (FI), France (FR), Greece (GR), Ireland (IE), Italy (IT), Latvia (LV), Lithuania (LT), Luxembourg (LU), Malta (MT), Netherlands (NL), Austria (AT), Poland (PL), Portugal (PT), Romania (RO), Sweden (SE), Slovakia (SK), Slovenia (SI), Spain (ES), Czech Republic (CZ), Hungary (HU), United Kingdom (GB) and Republic of Cyprus (CY). <b>EFTA Countries</b> Iceland, Liechtenstein, Norway and Switzerland <b>Other countries</b> Canada, USA, Japan, Ukraine, Australia, Columbia, Turkey, El Salvador

## K.4 EC declaration of conformity



### EG-Konformitätserklärung

### EC declaration of conformity

Für die nachfolgend bezeichneten Produkte:

We confirm that the following products:

#### **Testo 340** (bluetooth)

Best. Nr.: / Order No.: 0632 3340

wird bestätigt, daß sie den wesentlichen Schutzanforderungen entsprechen, die in der Richtlinie des Rates zur Angleichung der Rechtsvorschriften der Mitgliedstaaten über die **elektromagnetische Verträglichkeit** (2004/108/EG) festgelegt sind.

corresponds with the main protection requirements which are fixed in the EEC "Council Directive 2004/108/EC on the approximation of the laws of the member states relating to electromagnetic compatibility".  
The declaration applies to all samples of the above mentioned product.

Zur Beurteilung der Erzeugnisse hinsichtlich elektromagnetischer Verträglichkeit im Kleingewerbebereich wurden folgende Normen herangezogen:

*For assessment of the product following standards have been called upon:*

**Störaussendung / Pertubing radiation:**  
**Störfestigkeit: / Pertubing resistance:**

DIN EN 50270:2000-01 Typ 1  
DIN EN 50270:2000-01 Typ 2

**R&TTE Richtlinie:**

EN 300 328 V1.7.1 (2006-10)  
EN 301 489-1 V1.6.1 (2005-09)  
EN 301 489-17 V1.2.1 (2002-08)  
EN 60950-1 (2006-11)

**Sicherheits-Richtlinie:**

*This declaration is given in responsibility for:*

Diese Erklärung wird für:

**Testo AG**  
Postfach / P.O. Box 1140  
79849 Lenzkirch / Germany  
[www.testo.com](http://www.testo.com)

abgegeben durch / by:

Herr Walleser Mr. Walleser  
(Name) (name)

Vorstand Managing Director  
(Stellung im Betrieb des Herstellers) (Position in the company of the manufacturer)

Lenzkirch, 04.12.2009  
(Ort, Datum / place, date)

[Signature]  
(Rechtsgültige Unterschrift / Legally valid signature)



Der Hersteller betreibt ein zertifiziertes Qualitätssicherungssystem nach DIN ISO 9001

The manufacturer operates a certified quality assurance system according to DIN ISO 9001

## K.5 Principles of calculation

### K.5.1 Fuel parameters

Fuel	CO <sub>2</sub> max	O <sub>2</sub> ref	K <sub>gr</sub>	K <sub>net</sub>	K <sub>1</sub>	H	MH <sub>2</sub> O	Q <sub>gr</sub>	Q <sub>net</sub>
Natural Gas	11,90	3,00%	0,35%	0,39	40,00	24,4	0	53,42	48,16
Light Oil	15,50	3,00%	0,48%	0,51	53,00	13	0	45,6	42,8
Heavy Oil	15,80	3,00%	0,51%	0,51	54,00	11,5	0,2	42,9	40,5
Coal	18,40	7,00%	0,62%	0,65	63,00	4	13	26,75	25,5
Anthracit	19,10	7,00%	0,67%	0,69	65,00	3	12	29,65	28,95
Coke	20,60	7,00%	0,75%	0,76	70,00	0,4	10	27,9	27,45
Propane	13,80	3,00%	0,42%	0,45	48,00	18,2	0	50	46,3
Butan	4,10	3,00%	0,43%	0,46	48,00	17,2	0	49,3	45,8
Test gas	0,00	0,00%	0,00%	0,00	0,00	0	0	0	0
Diesel	15,60	3,00%	0,49%	0,53	53,00	12,9	0	44,62	41,8
Petrol	15,10	3,00%	0,46%	0,49	51,00	14,2	0	45,1	42,02

### K.5.2 Calculation formulae

Carbon dioxide: 
$$CO_2 = \frac{CO_{2max} \times (O_{2ref} - O_2)}{O_{2ref}}$$

CO<sub>2max</sub>: Fuel-specific carbon dioxide value  
 O<sub>2ref</sub>: O<sub>2</sub> reference value  
 O<sub>2</sub>: Measured oxygen content as %

Efficiency referred to Gross Efficiency:

$$Effg = 100 - \left( \left( \frac{K_{gr} \times (FT - AT)}{CO_2} \right) + \left( \frac{(MH_2O + 9 \times H) \times (2488 + 2.1 \times FT - 4.2 \times AT)}{Q_{gr} \times 1000} \right) + \left( \frac{K_1 \times CO}{CO_2 + CO} \right) \right)$$

Efficiency referred to Nett Efficiency:

$$Effn = 100 - \left( \left( \frac{K_{net} \times (FT - AT)}{CO_2} \right) + \left( \frac{(MH_2O + 9 \times H) \times (210 + 2.1 \times FT - 4.2 \times AT)}{Q_{net} \times 1000} \right) + \left( \frac{K_1 \times Q_{gr} \times CO}{Q_{net} \times (CO_2 + CO)} \right) \right)$$

K<sub>gr</sub>/K<sub>net</sub>/Q<sub>gr</sub>/Q<sub>net</sub>/K<sub>1</sub>/MH<sub>2</sub>O/H:  
 Fuel-specific factors  
 FT: Flue gas temperature  
 AT: Ambient temperature  
 CO: Measured carbon monoxide value in %  
 CO<sub>2</sub>: Calculated carbon dioxide value in %

Poison index:	$\text{ratio} = \frac{\text{CO}}{\text{CO}_2 \times 10000}$	CO:	Measured carbon monoxide value in %
		CO <sub>2</sub> :	Calculated carbon dioxide value
Excess Air (ExAir):	$= \left( \frac{21\%}{21\% - \text{O}_2} - 1 \right) \times 100$	21%:	Oxygen level of air
		O <sub>2</sub> :	Measured oxygen level in %
Nitrogen oxides:	No NO <sub>2</sub> sensor connected: <b>NO<sub>x</sub> = NO + (NO<sub>2Add</sub>, x NO)</b> NO <sub>2</sub> sensor connected: <b>NO<sub>x</sub> = NO + NO<sub>2</sub></b>	NO:	Measured nitrogen monoxide value
		NO <sub>2Add</sub> :	Nitrogen dioxide addition factor
Carbon monoxide undiluted:	$u\text{CO} = \text{CO} \times \lambda$	CO:	measured carbon monoxide content
		λ:	Calculated air ratio
Flue gas dew point:	$\text{DP} = \frac{\ln \left( \frac{F_{\text{H}_2\text{O}} \times P_{\text{Abs}}}{610.78} \right) \times 234.175}{\ln \left( \frac{F_{\text{H}_2\text{O}} \times P_{\text{Abs}}}{610.78} \right) - 17.08085}$	F <sub>H<sub>2</sub>O</sub> :	Flue gas-specific water vapour content as vol.%
		P <sub>Abs</sub> :	Absolute pressure in mbar/hPa
Flow speed:	$v = \sqrt{\frac{575 \times \Delta P \times (FT + 273.15)}{P_{\text{abs}}}} \times \alpha$	P <sub>abs</sub> :	Absolute pressure
		ΔP:	Differential pressure
		FT:	Flue gas temperature
		α:	Pitot tube factor
Air flow:	$V = v \times a$	v:	Flow speed
		a:	Cross-section area

## 56 K. Technical data

Mass flow:

**Mass flow CO:**  $MCO = CO \text{ [kg/h] [ppm]} \times F_{Gas} \times 1.25 \text{ [kg/m}^3\text{]} \times Z$

**Mass flow NO<sub>x</sub>:**  $MNO_x = NO_x \text{ [kg/h] [ppm]} \times F_{Gas} \times 2.05 \text{ [kg/m}^3\text{]} \times Z$

**Mass flow SO<sub>2</sub>:**  $MSO_2 = SO_2 \text{ [kg/h] [ppm]} \times F_{Gas} \times 2.86 \text{ [kg/m}^3\text{]} \times Z$

F<sub>gas</sub>: Fuel-specific humidity value  
T: Dew point  
Z: Calculation term (see below)

Calculation term Z:  $Z = \frac{273.15 \times P_{abs} \text{ [mbar]}}{273.15 + T \text{ [}^\circ\text{C]} \times 1013} \times V \text{ [m}^3\text{/s]} \times 10^{-6} \text{ [1/ppm]} \times 3600$

**Conversion from ppm to mg/m<sup>3</sup>:**

**Carbon monoxide:**  $CO \text{ [mg/m}^3\text{]} = \frac{O_{2ref} - O_{2Bez}}{O_{2ref} - O_2} \times CO \text{ [ppm]} \times 1.25$

**Nitrogen oxide:**  $NO_x \text{ [mg/m}^3\text{]} = \frac{O_{2ref} - O_{2Bez}}{O_{2ref} - O_2} \times NO_x \text{ [ppm]} \times 2.05$

**Sulfur dioxide:**  $SO_2 \text{ [mg/m}^3\text{]} = \frac{O_{2ref} - O_{2Bez}}{O_{2ref} - O_2} \times SO_2 \text{ [ppm]} \times 2.86$

O<sub>2ref</sub>: O<sub>2</sub> Reference value  
O<sub>2</sub>: Measured oxygen content as %  
O<sub>2Bez</sub>: Fuel-specific oxygen reference index as %



## K.6 Recommended rinsing times

Recommended rinsing times in measurements with high concentrations and longer measurements:

- Rinse instrument: Expose probe to fresh air and start flue gas analysis

Parameter	Concentration [ppm]	Measurement duration [min]	Recommended rinsing time [min]
CO	50	60	5
	100	30	5
	200	20	10
	500	10	10
	1000	10	15
	2000	10	20
	4000	5	30
	8000	5	60
COlow	10	60	5
	20	30	5
	50	20	10
	100	10	10
	200	10	15
	500	10	20
NO	50	60	5
	100	45	5
	200	30	5
	500	20	10
	1000	10	10
	2000	10	20
	3000	5	30
NOlow	10	60	5
	20	45	5
	50	30	5
	100	20	10
	200	10	10
	300	10	20
NO <sub>2</sub>	10	60	5
	20	45	5
	50	30	5
	100	20	10
	200	10	10
	500	10	20
SO <sub>2</sub>	50	60	5
	100	30	5
	200	20	10
	500	15	10
	1000	10	10
	2000	10	20
	5000	5	40



# L. Accessories/spare parts







Designation	Article no.
<b>Modular flue gas probes</b>	
Modular flue gas probe 335mm, 500°C, thermocouple 0.8mm	0600 9766
Modular flue gas probe 700mm, 500°C, thermocouple 0.8mm	0600 9767
Modular flue gas probe 335mm, 1000°C, thermocouple 0.8mm	0600 8764
Modular flue gas probe 700mm, 1000°C, thermocouple 0.8mm	0600 8765
Modular flue gas probe with preliminary filter 335mm, 1000°C, thermocouple 0.8mm	0600 8766
Modular flue gas probe with preliminary filter 700mm, 1000°C, thermocouple 0.8mm	0600 8767
<b>Probe modules/accessories for modular flue gas probes</b>	
Module probe shaft 700mm, 500°C, thermocouple 0.8mm	0554 9767
Module probe shaft 335mm, 1000°C, thermocouple 0.8mm	0554 8764
Module probe shaft 700mm, 1000°C, thermocouple 0.8mm	0554 8765
Module probe shaft with preliminary filter 335mm, 1000°C, thermocouple 0.8mm	0554 8766
Module probe shaft with preliminary filter 700mm, 1000°C, thermocouple 0.8mm	0554 8767
Extension lead for modular flue gas probe, 2.80m	0554 1202
Particle filter, 10 pcs	0554 3385
Replacement preliminary filter for modular flue gas probe with preliminary filter (2 pcs.)	0554 3372
<b>Industry engine probe</b>	
Engine probe without pre-filter	0600 7560
Engine probe with pre-filter	0600 7561
Thermocouple with 2.4 m hose, Tmax. 1000 °C	0600 8894
Spare probe shaft for engine probe with pre-filter	0554 7455
<b>Other probes/sensors</b>	
Pitot tube, 350mm	0635 2041
Pitot tube, 700mm	0635 2042
Ambient air temperature (AT) sensor, 60 mm	0600 9797
<b>Retrofit sensors</b>	
NOlow retrofitting kit	0554 2152
NO retrofitting kit	0554 2150
COlow-, H2-comp.- retrofitting kit	0554 2102
CO-, H2-comp.-retrofitting kit	0554 2100
NO2 retrofitting kit	0554 2200
SO2 retrofitting kit	0554 2250
<b>Replacement sensors</b>	
O <sub>2</sub> sensor	0393 0001
CO-, H2-comp. sensor	0393 0100
NOlow sensor	0393 0152
NO sensor	0393 0150
NO2 sensor	0393 0200
SO2 sensor	0393 0250
COlow-, H2-comp. sensor	0393 0102

<b>Designation</b>	<b>Article no.</b>
<b>Spare filters</b>	
CO-, H2-comp. sensor	0554 4100
NO sensor	0554 4150
<b>Other retrofitting kits</b>	
Bluetooth	only retrofittable by Testo service
Dilution of all sensors	only retrofittable by Testo service
<b>Other accessories</b>	
Infrared printer	0554 0549
Bluetooth printer incl. rechargeable battery and charging adapter	0554 0553
Mains unit	0554 1096
Charger with replacement battery	0554 1087
Replacement battery	0515 0100
Replacement thermal paper for printer (6 rolls)	0554.0568
Instrument/PC connecting cable	0449 0047
testo EasyEmission PC configuration software	0554 3334
Transport case	0516 3400

# Functional overview

The table gives an overview of the most important functions configured on the individual instruments. Detailed information about the individual functions can be found on the pages indicated.

Task	Call/function	see page
	 → Measurements → <input type="button" value="OK"/> →	
Flue gas measurement	Flue gas → <input type="button" value="OK"/>	38
Flue gas measurement with parallel flow measurement (+ air/mass flow calculation)	Flue gas + m/s → <input type="button" value="OK"/>	38
Flue gas measurement with parallel differential pressure measurement	Flue gas + $\Delta p2$ → <input type="button" value="OK"/>	38
Change/save/run measuring program	Program → <input type="button" value="OK"/>	39
Draught measurement	Draught → <input type="button" value="OK"/>	40
Enter smoke #/heat carrier temperature	Smoke # / HCT → <input type="button" value="OK"/>	40
Determine gas flow rate	Gas flow rate → <input type="button" value="OK"/>	41
Determine oil flow rate	Oil flow rate → <input type="button" value="OK"/>	42
Flow speed and pressure measurement	m/s → <input type="button" value="OK"/>	42
Pressure measurement	$\Delta p2$ → <input type="button" value="OK"/>	43
Read automatic furnace	Burner control → <input type="button" value="OK"/>	43
	 → Memory → <input type="button" value="OK"/> →	
Create new folder	New folder → <input type="button" value="OK"/>	22
Sort folder list by <b>Folder</b> , <b>Name</b> or <b>Addr'</b>	Folders list → <input type="button" value="Folder"/> or <input type="button" value="Name"/> or <input type="button" value="Addr'"/>	22
Sort locations list by order of creation	Restore list → <input type="button" value="OK"/>	22
Create new location	Folder → <input type="button" value="OK"/> → New location → <input type="button" value="OK"/>	22
Sort locations list by <b>location name</b>	Folder → <input type="button" value="OK"/> → Locations list → <input type="button" value="Locat"/>	22
Sort locations list by order of creation	Folder → <input type="button" value="OK"/> → Restore list → <input type="button" value="OK"/>	22
Activate location	Folder → <input type="button" value="OK"/> → Select location → <input type="button" value="OK"/>	22
Perform location settings	Folder → <input type="button" value="OK"/> → Select location → <input type="button" value="Change"/>	22
Display measurement data of one location	Folder → <input type="button" value="OK"/> → Select location → <input type="button" value="Data"/>	22
Print all measurement data of a location	Folder → <input type="button" value="OK"/> → Select location → <input type="button" value="Data"/> → <input type="button" value="Print all"/> → <input type="button" value="OK"/>	22
Delete all measurement data of a location	Folder → <input type="button" value="OK"/> → Select location → <input type="button" value="Data"/> → <input type="button" value="Delete all"/> → <input type="button" value="OK"/>	22
Display readings of a selected measurement protocol	Folder → <input type="button" value="OK"/> → Select location → <input type="button" value="Data"/> → Select protocol → <input type="button" value="Value"/>	22
Print a single measurement protocol	Folder → <input type="button" value="OK"/> → Select location → <input type="button" value="Data"/> → Select protocol → <input type="button" value="Print"/>	22

Task	Call/function	see page
	 → <b>Memory</b> → <b>Extra</b> →	
Print all protocols in the memory	<b>Print all data</b> → <b>OK</b>	22
Delete all protocols in the memory	<b>Delete all data</b> → <b>OK</b>	22
Clear whole memory (protocols and locations)	<b>Delete memory</b> → <b>OK</b>	22
	 → <b>Inst' settings</b> → <b>OK</b> →	
Set reading display	→ <b>Display edit</b> → <b>OK</b>	27
Select printer, set print text	→ <b>Printer</b> → <b>OK</b>	27
Set function key assignment, start screen	→ <b>Start keys edit</b> → <b>OK</b>	27
Set date/time	→ <b>Date/Time</b> → <b>OK</b>	27
Set language	→ <b>Language</b> → <b>OK</b>	27
Set automatic instrument disconnect	→ <b>AutoOff</b> → <b>OK</b>	27
	 → <b>Sensor settings</b> → <b>OK</b> →	
Display calibration data	<b>Calibration data</b> → <b>OK</b>	31
Set NO2 addition	<b>NO2 addition</b> → <b>Change</b>	31
Set O2 reference	<b>O2 reference</b> → <b>Change</b>	31
Set sensor protection	<b>Sensor protection</b> → <b>OK</b>	31
Display ppm/hour counter	<b>ppm/hour counter</b> → <b>OK</b>	31
Perform recalibration	<b>Recalibration</b> → <b>OK</b>	31
	 → <b>Fuels</b> → <b>OK</b> →	
Activate fuel	Select fuel → <b>OK</b>	35
Change fuel coefficients	Select fuel → <b>Coeff.</b>	35
	 -or-  → <b>Inst' diagnosis</b> → <b>OK</b> →	
Perform gas path check	<b>Gas path check</b> → <b>OK</b>	26
View instrument errors	<b>Error diagnosis</b> → <b>OK</b>	26
View sensor diagnosis	<b>Sensor diagnosis</b> → <b>OK</b>	26





