

GasAlert **Quattro**

1, 2, 3, and 4-Gas Detector

Operator's Manual

BW
Technologies
by Honeywell

Limited Warranty and Limitation Liability

BW Technologies LP (BW) warrants the product to be free from defects in material and workmanship under normal use and service for a period of two years, beginning on the date of shipment to the buyer. This warranty extends only to the sale of new and unused products to the original buyer. BW's warranty obligation is limited, at BW's option, to refund of the purchase price, repair or replacement of a defective product that is returned to a BW authorized service center within the warranty period. In no event shall BW's liability hereunder exceed the purchase price actually paid by the buyer for the Product.

This warranty does not include:

- a) fuses, disposable batteries or the routine replacement of parts due to the normal wear and tear of the product arising from use;
- b) any product which in BW's opinion, has been misused, altered, neglected or damaged, by accident or abnormal conditions of operation, handling or use;
- c) any damage or defects attributable to repair of the product by any person other than an authorized dealer, or the installation of unapproved parts on the product; or

The obligations set forth in this warranty are conditional on:

- a) proper storage, installation, calibration, use, maintenance and compliance with the product manual instructions and any other applicable recommendations of BW;
- b) the buyer promptly notifying BW of any defect and, if required, promptly making the product available for correction. No goods shall be returned to BW until receipt by the buyer of shipping instructions from BW; and
- c) the right of BW to require that the buyer provide proof of purchase such as the original invoice, bill of sale or packing slip to establish that the product is within the warranty period.

THE BUYER AGREES THAT THIS WARRANTY IS THE BUYER'S SOLE AND EXCLUSIVE REMEDY AND IS IN LIEU OF ALL OTHER WARRANTIES, EXPRESS OR IMPLIED, INCLUDING BUT NOT LIMITED TO ANY IMPLIED WARRANTY OF MERCHANTABILITY OR FITNESS FOR A PARTICULAR PURPOSE. BW SHALL NOT BE LIABLE FOR ANY SPECIAL, INDIRECT, INCIDENTAL, OR BASED ON CONTRACT, TORT OR RELIANCE OR ANY OTHER THEORY.

Since some countries or states do not allow limitation of the term of an implied warranty, or exclusion or limitation of incidental or consequential damages, the limitations and exclusions of this warranty may not apply to every buyer. If any provision of this warranty is held invalid or unenforceable by a court of competent jurisdiction, such holding will not affect the validity or enforceability of any other provision.

Contacting BW Technologies by Honeywell

USA: 1-888-749-8878

Canada: 1-800-663-4164

Europe: +44(0) 1295 700300

Other countries: +1-403-248-9226

Email us at: info@gasmonitors.com

Visit BW Technologies by Honeywell's website at: www.gasmonitors.com

GasAlertQuattro

Introduction

The operator's manual provides basic information to operate the GasAlertQuattro gas detector. For complete operating instructions, refer to the *GasAlertQuattro Technical Reference Guide* provided on the CD-ROM. The GasAlertQuattro gas detector ("the detector") is designed to warn of hazardous gas levels above user-defined alarm setpoints.

The detector is a personal safety device. It is your responsibility to respond properly to the alarm.

Note

The detector is shipped with English as the default displayed language. Additional languages provided are French, German, Portuguese, and Spanish. The screens for the additional languages are displayed on the detector and in the corresponding operator's manual.

Zeroing the Sensors

To zero the sensors, refer to steps #1-3 in Calibration on page 8.

Safety Information - Read First

Use the detector only as specified in this operator's manual and the technical reference guide, otherwise protection provided by the detector may be impaired. Read the following **Cautions** before using the detector.

⚠ Cautions

- **Warning:** Substitution of components may impair Intrinsic Safety.
- Before using the detector, refer to [Sensor Poisons and Contaminants](#).
- Protect the combustible sensor from exposure to lead compounds, silicones, and chlorinated hydrocarbons. Although certain organic vapors (such as leaded gasoline and halogenated hydrocarbons) may temporarily inhibit sensor performance, in most cases the sensor will recover after calibration.
- **Caution:** For safety reasons, this equipment must be operated and serviced by qualified personnel only. Read and understand the technical reference guide completely before operating or servicing.

- Charge the detector before first-time use. BW Technologies by Honeywell recommends the detector be charged after every workday.
- Calibrate the detector before first-time use and then on a regular schedule, depending on use and sensor exposure to poisons and contaminants. BW recommends that the sensors must be calibrated regularly and at least once every 180 days (6 months).
- Calibrate only in a safe area that is free of hazardous gas in an atmosphere of 20.9% oxygen.
- The combustible sensor is factory calibrated to 50% LEL methane. If monitoring a different combustible gas in the % LEL range, calibrate the sensor using the appropriate gas.
- Only the combustible gas detection portion of this instrument has been assessed for performance by CSA International.
- BW recommends that the combustible sensor be checked with a known concentration of calibration gas after any exposure to contaminants/poisons such as sulfur compounds, silicon vapors, halogenated compounds, etc.
- BW recommends to bump test the sensors before each day's use to confirm their ability to respond to gas by exposing the detector to a gas concentration that exceeds the alarm setpoints. Manually verify that the audible, visual, and vibrator alarms are activated. Calibrate if the readings are not within the specified limits.
- **Caution:** High off-scale LEL readings may indicate an explosive concentration.





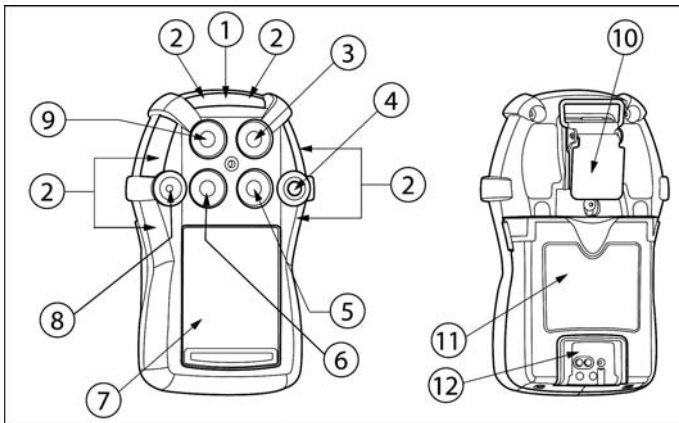



















- Any rapid upscaling reading followed by a declining or erratic reading may indicate a gas concentration beyond upper scale limit, which can be hazardous.
- For use only in potentially explosive atmospheres where oxygen concentrations do not exceed 20.9% (v/v).
- Extended exposure of the GasAlertQuattro to certain concentrations of combustible gases and air may stress the detector element that can seriously affect its performance. If an alarm occurs due to a high concentration of combustible gases, a calibration should be performed, or if needed, the sensor replaced.
- **Warning:** The lithium battery (QT-BAT-R01) may present a risk of fire or chemical burn hazard if misused. Do not disassemble, heat above 212°F (100°C), or incinerate.
- **Warning:** Do not use any other lithium batteries with the GasAlertQuattro detector. Use of any other cell can cause fire and/or explosion. To order and replace the QT-BAT-R01 lithium battery, contact [BW Technologies by Honeywell](#).
- **Warning:** Lithium polymer cells exposed to heat at 266°F (130°C) for 10 minutes can cause fire and/or explosion.
-  **Warning:** This instrument contains a lithium polymer battery. Dispose of used lithium cells immediately. Do not disassemble and do not dispose of in fire. Do not mix with the solid waste stream. Spent batteries must be disposed of by a qualified recycler or hazardous materials handler.
- Keep lithium cells away from children.
- Deactivating the detector by removing the battery pack may cause improper operation and harm the detector.

Parts of the GasAlertQuattro



Item	Description	Item	Description	Item	Description	Item	Description
1	IntelliFlash (green LED)	4	Pushbutton	7	Liquid crystal display (LCD)	10	Alligator clip
2	Visual alarm indicator (red LED)	5	Combustible (LEL) sensor	8	Audible alarm	11	Battery pack
3	Hydrogen sulfide (H ₂ S) sensor	6	Carbon monoxide (CO) sensor	9	Oxygen (O ₂) sensor	12	Charging connector and IR interface

Screen Elements

	Calibration gas cylinder		Display during startup to indicate audio and visual alarm pass or fail during a MicroDock II bump test		Displays if calibration is initiated and the IR Lock option is enabled
	Bump test gas cylinder		Displays when the Stealth option is enabled		Displays during calibration and when startup is complete
	Indicates pass for startup, sensors, calibrations, and bump tests		Displays when the detector is in alarm (not applicable to TWA and STEL)		Battery — full charge
	Indicates fail for startup, sensors, calibrations, and bump tests		Displays when there is a warning, failure, error, or low battery		Battery — half charge
	Pushbutton displays when screen provides an option to end or skip		Heartbeat pulses continually during normal operation to verify the detector is operating correctly		Low battery warning
20.9 O ₂ %	Reading displays with white background during normal operation		Displays for STEL alarms and setpoints		Displays when the detector is connected to an IR Link
19.5 O ₂ %	Reading displays with black background when the sensor is in alarm		Displays for TWA alarms and setpoints		Displays when the detector is communicating with Fleet Manager II
	Grey check box displays during bump tests or calibration when a gas is not due		Displays during peak gas exposure information screens		Displays when the detector's firmware is being updated
	Displays when the most recent calibration or bump test failed but a previous calibration or bump test is still valid within the due date. Also displays during auto-zero.		Displays during an operation such as auto-zeroing		Displays when gas should no longer be applied after a bump test or calibration

Pushbutton

Pushbutton	Description
	<ul style="list-style-type: none"> • To activate the detector, press and hold ○ in a safe area that is free of hazardous gas and in an atmosphere of 20.9% oxygen. • To deactivate the detector, press and hold ○ during the powering off countdown. Release ○ when OFF displays. • To view the date/time, current battery power, calibration due date, bump test due date, TWA, STEL, and peak readings, press ○ twice rapidly. To clear the TWA, STEL, and peak readings, press and hold ○ when the LCD displays Hold ○ to reset peaks, TWA, STEL. • To initiate calibration, press and hold ○ while the detector performs the OFF countdown. Continue holding ○ while the LCD briefly deactivates and then reactivates to begin the calibration countdown. Release ○ when Calibration started displays. • To activate the backlight, press ○ and release. • To acknowledge latching alarms, press ○. • To acknowledge a low alarm and disable the audible alarm, press ○. The Low Alarm Acknowledge option must be enabled in Fleet Manager II. • To acknowledge any of the “due today” messages (calibration and bump test) press ○. If enabled, the force calibration and force bump features cannot be bypassed.

Sensor Poisons and Contaminants

Several cleaners, solvents, and lubricants can contaminate and cause permanent damage to sensors. Before using cleaners, solvents, and lubricants in close proximity to the detector sensors, read the following caution and table.

⚠ Caution

Use only the following BW Technologies by Honeywell recommended products and procedures:

- **Use water based cleaners.**
- **Use non-alcohol based cleaners.**
- **Clean the exterior with a soft, damp cloth.**
- **Do not use soaps, polishes, or solvents.**

The following table lists common products to avoid using around sensors.

Cleaners and Lubricants	Silicones	Aerosols
Brake cleaners	Silicone cleaners and protectants	Bug repellents and sprays
Lubricants	Silicone based adhesives, sealants, and gels	Lubricants
Rust inhibitors	Hand/body and medicinal creams that contain silicone	Rust inhibitors
Window and glass cleaners	Tissues containing silicone	Window cleaners
Dishsoaps	Mold releasing agents	
Citrus based cleaners	Polishes	
Alcohol based cleaners		
Hand sanitizer		
Anionic detergents		
Methanol (fuels and antifreezes)		

Connecting the Gas Cylinder to the Detector

Gas Cylinder Guidelines

- To ensure accurate calibration, use a premium-grade calibration gas. Use gases approved by the National Institute of Standards and Technology.
- If a certified calibration is required, contact BW Technologies by Honeywell.
- Do not use a gas cylinder past its expiration date.

Gas Cylinder Connection

Read the following steps (1-5) prior to initiating calibration.

1. Verify the calibration gas being used matches the span concentration value(s) that are set for the detector.
2. Connect the calibration hose to the 0.5 l/min regulator on the gas cylinder. For use with the MicroDock II, use a demand flow regulator and refer to the *MicroDock II User Manual*.
3. Connect the calibration hose to the intake inlet on the calibration cap. Arrows on the calibration cap indicate the direction of gas flow.
4. Begin the calibration procedures. Do not attach the calibration cap until instructed to apply gas. When instructed, place the calibration cap on the detector and tighten the knob.
NOTE: Ensure the cap is securely fastened before applying gas.
5. When calibration is complete, disconnect the hose from the calibration cap and the regulator. Remove the calibration cap from the detector.



Note

Only use the calibration cap during the calibration process.

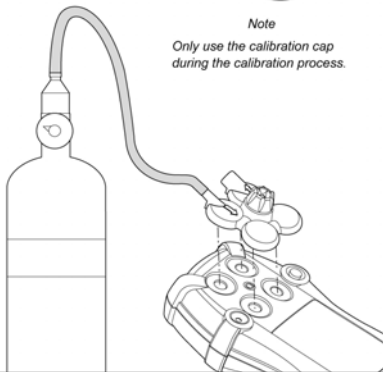

Calibration

Calibration is performed to adjust the sensitivity levels of sensors to ensure accurate responses to gas.

This calibration procedure is written as the procedure is intended. If an error or alarm screen displays, refer to Calibration Troubleshooting in the *GasAlertQuattro Technical Reference Guide*.

⚠ Caution

Calibrate only in a safe area that is free of hazardous gas in an atmosphere of 20.9% oxygen.

If performing single gas calibration, calibrate O₂ first.

Note

The maximum hose length for calibration is 3 ft. (1 m).

The following steps are written for use with a standard quad gas cylinder.

*Calibration can only be aborted after the sensors have been zeroed. If  is pressed to abort, **CALIBRATION cancelled** displays.*

1. Press and hold  as the detector performs the **Powering off** countdown.

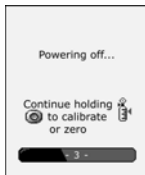

Continue holding  when **OFF** displays and the detector briefly deactivates.



2. The detector activates again and performs the calibration countdown. Continue holding until **Starting Calibration** displays.



3. The detector enters the zero function. **zeroing** displays while the detector zeros all of the sensors.

⚠ Caution

If a sensor fails to zero, it cannot be calibrated. Refer to Startup Self-Test Troubleshooting in the *GasAlertQuattro Technical Reference Guide*.

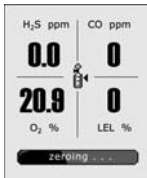

If the **IR Lock** option is enabled, the following screen displays to indicate calibration can only be performed using an IR device (MicroDock II or IR Link).



4. When the following screen displays, attach the calibration cap and apply calibration gas at a flow rate of 250-500 ml/min. Refer to [Connecting the Gas Cylinder to the Detector](#).

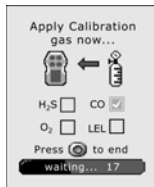

If a sensor is not yet due for calibration, its box will have a greyed out checkmark.

5. The detector initially tests for gas. When a sufficient amount of gas is detected, displays beside each gas that is detected.

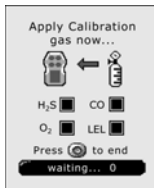

6. The detector then begins calibrating the sensors. The following activities occur during the span:

- **calibrating** displays at the bottom of the screen.
- Gas values adjust during the span.
- Target gas values that are defined in Fleet Manager II display above or below the adjusting gas value.

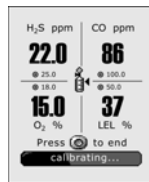

To abort calibration after the sensors have been zeroed, press .

7. When the following screen displays, close the valve on the gas cylinder and remove the calibration cap from the detector.

A check mark displays beside each sensor that has calibrated successfully.

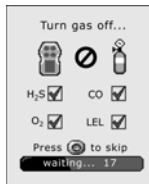

8. When calibration is complete, the following screen displays.

Note

The calibration due date cannot be reset for a sensor that fails calibration. If a sensor fails or an error screen displays, refer to Calibration Troubleshooting in the GasAlertQuattro Technical Reference Guide.

9. All successfully calibrated sensors automatically reset to the number of days defined in the **Cal Interval** field in Fleet Manager II.

The calibration due dates can be changed in Fleet Manager II.

10. The detector now enters normal operation.

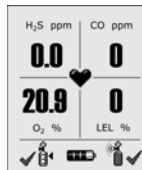
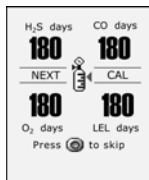

Bump Test

A bump test applies test gas to force the detector into alarm. A bump test should be performed regularly to confirm the sensors are responding correctly to gas, and that the audible, visual and vibrator alarms activate during an alarm condition.

The detector can also prompt for a bump test during startup when the Bump Test Interval is defined. Refer to the *GasAlert-Quattro Technical Reference Guide*.

⚠ Caution

BW recommends to bump test the sensors before each day's use to confirm their ability to respond to gas by exposing the sensors to a gas concentration that exceeds alarm setpoints.

1. Connect the calibration hose to the 0.5 l/min regulator on the gas cylinder. Refer to [Connecting the Gas Cylinder to the Detector](#).



To bump test using the MicroDock II station, refer to the *MicroDock II User Manual*.

2. Connect the calibration hose to the intake inlet on the calibration cap. Arrows on the calibration cap indicate the direction of gas flow.
3. Attach and tighten the calibration cap onto the detector and apply gas. Verify the visual, audible, and vibrator alarms activate.
4. Close the regulator and remove the calibration cap. The detector temporarily remains in alarm until the gas clears from the sensors.

Alarms



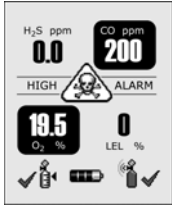
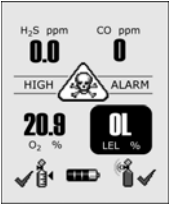

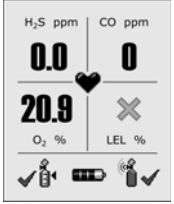
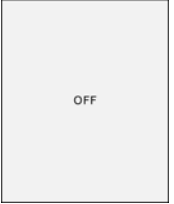
Refer to the following table for information about alarms and corresponding screens. For more information about alarms refer to the *GasAlertQuattro Technical Reference Guide*.

Alarm	Screen	Alarm	Screen
<p>Low Alarm</p> <ul style="list-style-type: none"> • Slow siren (upward tone) • Slow flash • Black box around gas flashes • Vibrator alarm activates 		<p>TWA Alarm</p> <ul style="list-style-type: none"> • Fast siren (downward tone) • Fast flash • Black box around gas flashes • Vibrator alarm activates 	
<p>High Alarm</p> <ul style="list-style-type: none"> • Fast siren (downward tone) • Fast flash • Black box around gas flashes • Vibrator alarm activates 		<p>STEL Alarm</p> <ul style="list-style-type: none"> • Fast siren (downward tone) • Fast flash • Black box around gas flashes • Vibrator alarm activates 	

Alarm	Screen	Alarm	Screen
<p>Multi Alarm</p> <ul style="list-style-type: none"> • Alternating low and high alarm siren and flash • Black box around gas flashes • Type of alarm alternates • Vibrator alarm activates 		<p>Over Limit (OL) Alarm</p> <ul style="list-style-type: none"> • Fast siren (downward tone) • Fast flash • Black box around gas flashes • Vibrator alarm activates <p><i>Note: LCD may also display an under limit reading (-OL)</i></p>	
<p>Sensor Failure Alarm</p> <ul style="list-style-type: none"> •  displays 		<p>Normal Deactivation</p> <ul style="list-style-type: none"> • Sequence of alternating beeps and alternating flashes • Vibrator alarm activates • Countdown initiates • OFF displays 	

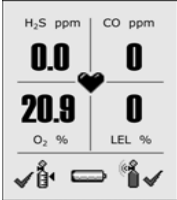
Note

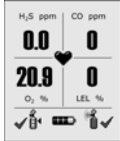
If enabled, during an alarm condition the **Latching Alarms** option causes the low and high gas alarms (audible, visual, and vibrator) to persist until the alarm is acknowledged by pressing  and the gas concentration is below the low alarm setpoint. The peak concentration values display continually until the alarm no longer exists. Enable/disable **Latching Alarms** in Fleet Manager II. Local regulations may require the **Latching Alarms** option be enabled.

Alarm	Screen	Alarm	Screen
<p>Low Battery Alarm</p> <ul style="list-style-type: none"> Sequence of 10 rapid sirens and alternating flashes with 7 seconds of silence in between (continues for 15 minutes)  flashes Vibrator alarm pulses After 15 minutes of the low battery alarm sequence, the detector enters critical battery alarm (see Critical Battery Alarm below) 		<p>Confidence/compliance Beep</p> <ul style="list-style-type: none"> One beep every 1-120 seconds (beep frequency is defined with Confidence/compliance Beep Interval option) <p>IntelliFlash (default: one flash every 1 second)</p> <ul style="list-style-type: none"> One flash every 1-120 seconds (flash frequency is defined with IntelliFlash Interval option) <p>Heartbeat</p> <ul style="list-style-type: none">  pulses once every second to verify detector is operating correctly 	 <p><i>Note: Confidence/compliance beep and IntelliFlash automatically deactivate during a low battery alarm, calibration fail, bump test fail, self-test fail, and in an alarm condition.</i></p>
<p>Critical Battery Alarm</p> <ul style="list-style-type: none"> Fifteen minutes after low battery alarm activates, sequence of 10 rapid sirens and alternating flashes with 1 second of silence in between (sequence reactivates seven times) Vibrator alarm pulses Low Battery Powering Off displays and the detector deactivates 		<p style="text-align: center;"><i>Note</i></p> <p><i>If the Low Alarm Acknowledge option is enabled, the audible alarm can be disabled during a low alarm condition. The LED and visual alarm indicators remain active until the alarm condition changes or the detector deactivates. Press  to acknowledge the low alarm and deactivate the audible alarm. If the alarm escalates to a high, TWA, or STEL alarm, the audible alarm reactivates.</i></p>	

User Options and Sensor Configuration

The following items are required to modify the user options and sensor configuration:

- Detector
- IR Link adapter or MicroDock II
- Fleet Manager II software

Refer to the *GasAlertQuattro Technical Reference Guide* and *Fleet Manager II Operator's Manual* for complete information.

Maintenance

To maintain the detector in good operating condition, perform the following basic maintenance as required.

- Calibrate, bump test, and inspect the detector on a regular schedule.
- Maintain an operations log of all maintenance, bump tests, calibrations, and alarm events.
- Clean the exterior with a soft damp cloth. Do not use solvents, soaps, or polishes. Refer to [Sensor Poisons and Contaminants](#).

Rechargeable Battery Capacity

A rechargeable battery's runtime decreases approximately 20% over a two-year period of typical use.

Battery Pack Retaining Screw

The retaining screw (QAQD-20x) provided with the detector must be used to lock the battery pack on all European and

IECEx scheme detectors, and on all Canadian and U.S. Zone Certified detectors.

The screwdriver included with the detector has a double-ended driver. Loosen the brass nut to switch between a Phillips head and a hex head.

A hex tool is required to tighten and loosen the retaining screw. Tighten the screw 1-2 turns using 3-4 in-lbs of torque. Do not overtighten the screw.

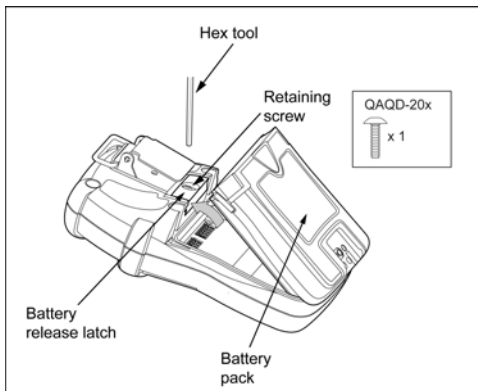

Replacing the Battery Pack

The alkaline and rechargeable battery packs can be changed in hazardous locations.

1. Press and hold  to deactivate the detector.
2. If using the retaining screw, loosen it 1-2 turns. Push the battery release latch toward the top of the detector to release the battery pack.
3. From the top of the battery pack, lift upward to remove.
4. Insert a new battery pack. Insert the bottom of the battery pack first, then lower the top into place. Press until the release tab engages. Tighten the retaining screw if required.

Charging the Rechargeable Battery Pack

Warning

To avoid personal injury and/or damage to the detector, adhere to following:

Charge only in a safe area that is free of hazardous gas within temperatures of 32°F to 104°F (0°C to 40°C).

Charge the battery immediately when the detector emits a low battery alarm.

Charge the lithium battery pack using the BW supplied charger and charger adapter only. The charging adapter is specific to your region. Use of the charging adapter outside your region will damage the charger

and the detector. Failure to adhere to this caution can lead to fire and/or explosion.

Charge the lithium battery after each workday.

1. Press and hold  to deactivate the detector, then plug the charger into an AC outlet.

Note

The time required to charge will increase if the detector is activated.

2. Connect the charging adapter to the detector IR receptacle. Refer to the following illustration.

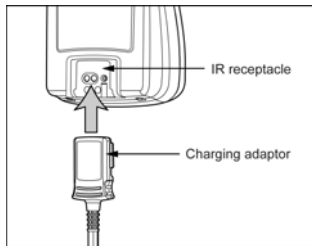

3. The lithium battery may require 6 hours to reach full capacity.

Replacing the Alkaline Batteries

⚠ Warning

To avoid personal injury and/or damage to the detector, use only BW recommended alkaline batteries. Refer to [Specifications](#).

Change the alkaline batteries only in safe area that is free of hazardous gas.

1. Press and hold  to deactivate the detector.
2. If using the retaining screw, loosen the retaining screw 1-2 turns. Remove the alkaline battery pack. Refer to [Replacing the Battery Pack](#).
3. Unhook the ejector bar from the release clasp. Move the ejector bar towards the top of the battery pack until it is aligned horizontally over the batteries.

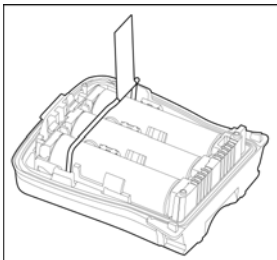

4. Using the tab, pull on the ejector bar.

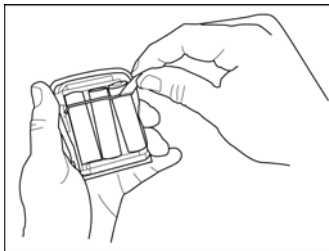

5. To the left of the tab, pull up on the ejector bar.

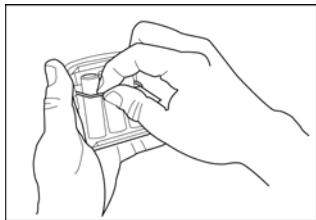

6. Remove the spent batteries. Reset the ejector bar to its original flat position. Ensure the ejector bar engages the release clasp.

7. Insert the new batteries. Position the positive end of the battery at a 30° angle and insert into the battery pack before pushing the negative end down. Ensure the batteries are not inserted over the tab.

Note

Ensure all three batteries are inserted with the positive end pointing toward the top of the battery pack.

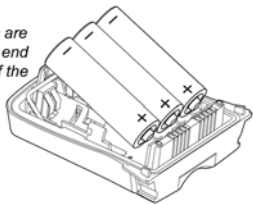

8. Replace the battery pack by inserting the bottom first, then lower top into place. Ensure the tab is tucked in before replacing the battery pack. Press until the release tab engages. If required, tighten the retaining screw using 3-4 in. lbs torque.

Replacing the Sensors

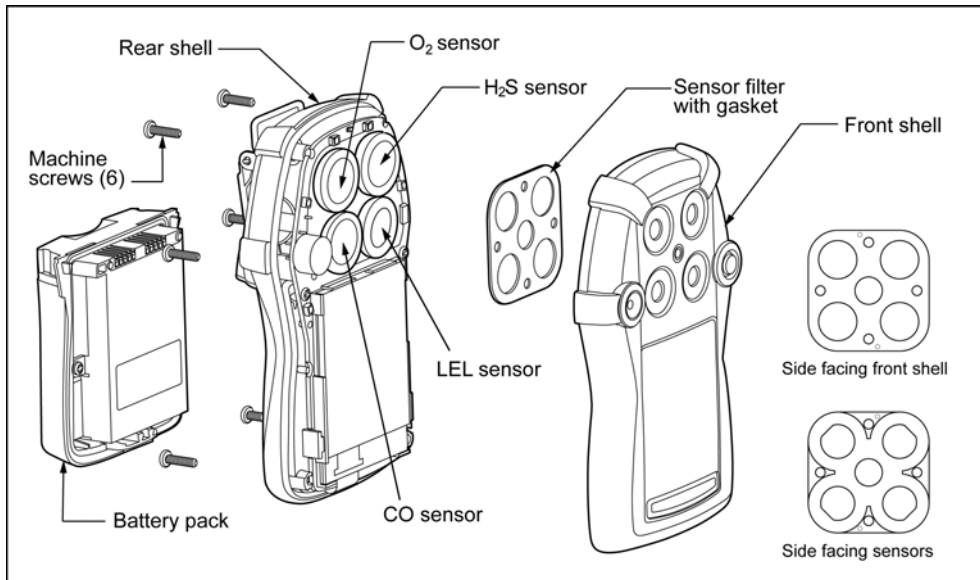

⚠ Warning

To avoid personal injury and/or property damage, only use sensors that are specifically designed for the detector.

Note

Detectors that are configured for 1, 2, or 3 gases may contain a dummy sensor in one of the four sensor locations.

To replace a sensor or sensor filter, refer to the illustration [Replacing the Sensors](#) and the following steps #1-8.

1. Press and hold  to deactivate the detector. Press the release latch, and remove the battery pack.
2. Remove the six machine screws from the rear shell.
3. Remove the front shell.
4. Remove the spent sensor(s). Ensure no damage occurs to the LCD.
5. Insert the new sensor(s).
6. Reassemble the detector. Press the front and rear shells together firmly to ensure a proper seal. Ensure the front and rear shells have a tight, uniform 1/16 in. (1.5 mm) seal on all sides of the detector.
7. Replace the six machine screws using 3-4 in. lbs torque. Do not overtighten the screws. Replace the battery pack.
8. New sensors must be calibrated prior to use. Calibrate the new sensor(s) immediately. Refer to [Calibration](#).

Replacing the Sensor Filter

To replace the filter, refer to the illustration [Replacing the Sensors](#) and the following steps #1-6.

1. Press and hold  to deactivate the detector. Press the release latch, and remove the battery pack.
2. Remove the six machine screws from the rear shell.
3. Remove the front shell. Remove the sensor filter.
4. Refer to the following illustration before inserting the new filter. Ensure the filter is laying flat and that the holes are correctly aligned over the filter posts.

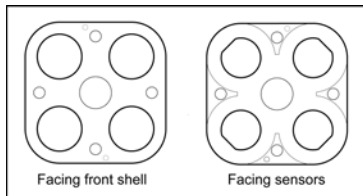

5. Replace the front shell. Press the front and rear shells together firmly to ensure a proper seal. Ensure the front and rear shells have a tight, uniform 1/16 in. (1 mm) seal on all sides of the detector.
6. Replace the six machine screws using 3-4 in. lbs torque. Do not overtighten the screws. Replace the battery pack.

Specifications

Instrument dimensions: 12.9 x 8.0 x 3.8 cm
(5.1 x 3.2 x 1.5 in.)

Weight: 330 g (11.7 oz.)

Operating temperature: -20°C to +50°C (-4°F to +122°F)

Storage temperature: -40°C to +60°C (-40°F to +140°F)

Operating humidity: 10% to 100% relative humidity
(non-condensing)

Dust and moisture ingress: IP66/67 (with screw engaged)

Alarm setpoints: May vary by region and are user-defined

Detection range:

H₂S: 0 - 200 ppm (0.1 ppm increments)

CO: 0 - 1000 ppm (1 ppm increments)

O₂: 0 - 30.0% vol. (0.1% vol. increments)

Combustible (LEL): 0 - 100% (1% LEL increments) or
0 - 5.0% v/v methane

Sensor type:

H₂S, CO, O₂: Single plug-in electrochemical cell

Combustibles: Plug-in catalytic bead

O₂ measuring principle: Capillary controlled concentration sensor

Bump test specified limits: BW recommends using a gas cylinder that will ensure the combustible sensor has an accuracy of -0 to +20% of actual reading (reference CAN/CSA C22.2 No. 152)

Alarm conditions: TWA alarm, STEL alarm, low alarm, high alarm, multi alarm, over limit (OL) alarm, low battery alarm, critical low battery alarm, sensor failure alarm, IntelliFlash, confidence/compliance beep

Audible alarm: 95 dB at 30 cm (12 in.) variable pulsed beeper

Visual alarm: Red light-emitting diodes (LEDs)

IntelliFlash: Green light-emitting diode. Flash frequency is user-defined with IntelliFlash interval option

Confidence/compliance beep: Audible beep from variable pulsed beeper. Beep frequency is user-defined with confidence/compliance beep interval option

Display: Alphanumeric liquid crystal display (LCD) with flip display (0° or 180°) capability (user-defined in Fleet Manager II)

Backlight: Activates upon startup and deactivates when self-test is complete. Activates when the pushbutton is pressed and deactivates after 10 seconds. Also activates during an alarm condition and remains lit until alarm ceases

Internal vibrator: Vibrates during activation, deactivation, and all alarms

Self-test: Initiated during activation, self-test runs continuously on the battery and electrochemical sensors (H₂S and CO) while detector is operational

Calibration: Zero and automatic span

User options: Startup message, lockout on self-test error, safe mode, IntelliFlash, confidence/compliance beep, latching alarms, force calibration, force bump, calibration IR lock, flip display stealth mode, datalog interval, IntelliFlash interval, confidence/compliance beep interval, and language selection

Sensor options: Sensor enable/disable, calibration gas values, calibration interval, bump test interval, alarm setpoints (low/high/TWA/STEL), STEL interval, TWA period, auto zero at startup enable/disable, LEL correction factor, 10% (of reading) over-span, low alarm acknowledge, O₂ measurement, LEL gas measurement, %vol methane measurement

Year of manufacture: The detector's year of manufacture is determined from the serial number. The second and third number after the second letter determines the year of manufacture. E.g., QA109-001000 = 2009 year of manufacture

Approved lithium battery for GasAlertQuattro product:
Lithium-ion polymer (QT-BAT-R01) as per standards UL913, EN60079-11, EN60079-0, C22.2 No. 157

Rechargeable battery (QT-BAT-R01) Temperature code
Lithium polymer $-20^{\circ}\text{C} \leq T_a \leq +50^{\circ}\text{C}$ T4

Lithium battery operating time: One rechargeable lithium polymer battery provides the following operating runtimes:

20 hours at 20°C (68°F)

18 hours at -20°C (-4°F)

Approved alkaline battery pack for GasAlertQuattro (QT-BAT-A01): as per standards UL913, EN60079-11, EN60079-0, C22.2 No. 157

Approved alkaline batteries for GasAlertQuattro product:

Duracell MN1500 $-20^{\circ}\text{C} \leq T_a \leq +50^{\circ}\text{C}$ T4 (129.9°C)

Energizer E91VP $-20^{\circ}\text{C} \leq T_a \leq +50^{\circ}\text{C}$ T3C (135.3°C)

AA alkaline battery operating time:

14 hours at 20°C (68°F)

Battery charger: Charging adapter

First-time charge: 6 hours

Normal charge: 6 hours

Warranty: 2 years including sensors

Approvals:

Approved by CSA to both U.S. and Canadian Standards
CAN/CSA C22.2 No. 157 and C22.2 152

ANS/UL - 913 and ANSI/ISA - S12.13 Part 1

CSA Class I, Division 1, Group A, B, C, D
ATEX CE 0539 (E) II 1 G Ga Ex ia IIC T4 for Zone 0
 Group IIC
 KEMA 09 ATEX 0137
 EN 60079-0, EN 60079-11, EN 60079-26
IECEx Ga Ex ia IIC T4 IECEx CSA 09.0006
 IEC 60079-0, IEC 60079-11, IEC 60079-26

This equipment has been tested and found to comply with the limits for a Class B digital device, pursuant to Part 15 of the FCC Rules and ICES-003 Canadian EMI requirements. These limits are designed to provide reasonable protection against harmful interference in a residential installation. This equipment generates, uses and can radiate radio frequency energy and, if not installed and used in accordance with the instructions, may cause harmful interference to radio communications. However, there is no guarantee that interference will not occur in a particular installation. If this equipment does cause harmful interference to radio or television reception, which can be determined by turning the equipment off and on, the user is encouraged to try to correct the interference by one or more of the following measures:

- Reorient or relocate the receiving antenna.
- Increase the separation between the equipment and receiver.
- Connect the equipment into an outlet on a circuit different from that to which the receiver is connected.
- Consult the dealer or an experienced radio/TV technician for help.

Wear yellow. Work safe.

iERP: 127890

D6445/0 [English]

© BW Technologies 2009. All rights reserved.