

X5 Personal Gas Detector



Operating Manual

Honeywell

Limited Warranty and Limitation of Liability

All products are designed and manufactured to the latest internationally recognized standards by Honeywell Analytics under a Quality Management system that is certified to ISO 9001:2000.

Device	Warranty Terms
X5 Personal Gas Detector	24 months from date of switch on / installation
Service	Warranty Terms
A. Replacement with new product within the first 90 days of the original warranty period.	Full warranty period as specified in Warranty Terms above.
B. Repair (or replacement with new or reconditioned product at HA discretion) after the first 90 days of the original warranty period.	Pro-rata warranty realized as balance of original warranty specified in Warranty Terms above, or equivalent discounted price on a new, fully warranted instrument or component.
Components replaced under original product warranty.	Warranted against same fault for 3 months from date of repair
Repair or Replacement outside of original warranty period.	

Warranty Conditions

- The HA Limited Product Warranty only extends to the sale of new and unused products to the original buyer where purchased from a HA authorized distributor or service center.
- Not covered are:
 - consumable items such as dry-cell batteries, filters and fuses or routine replacement parts due to the normal wear and tear of the product;
 - any product which in HAs opinion has been altered, neglected, misused or damaged by accident or abnormal conditions of operation, handling, use or severe sensor poisoning; or failure to maintain and calibrate the product as prescribed in the product documentation;
 - defects attributable to improper installation, repair by an unauthorized person or the use of unauthorized accessories/parts on the product;
- Any claim under the HA Product Warranty must be made within the warranty period and as soon as reasonably possible after a defect is discovered.
- If a Warranty claim is being sought it is the responsibility of the buyer to return the product to the distributor or HA authorized service center along with a full description of the fault.
- A warranty claim will be accepted if conditions contained within this Warranty are met. When, in the opinion of HA, a warranty claim is valid, HA will repair or replace the defective product according to the terms herein.
- Please note that if, in the opinion of HA the warranty claim is not valid, HA will, at the option of the buyer, return the unit unaltered at the buyers expense, repair the unit at the then prevailing rates, replace the unit with an appropriate replacement item at the then prevailing price, or discard the unit.
- In no event shall HAs liability exceed the original purchase price paid by the buyer for the product.
- HA makes no other warranty expressed or implied except as stated above.

Contacting Honeywell Analytics

Copyright 2008 by Honeywell International Inc.

While this information is presented in good faith and believed to be accurate, Honeywell disclaims the implied warranties of merchantability and fitness for a particular purpose and makes no express warranties except as may be stated in its written agreement with and for its customers.

In no event is Honeywell liable to anyone for any indirect, special or consequential damages. The information and specifications in this document are subject to change without notice.

Other brand or product names are trademarks of their respective owners.

Honeywell Analytics Inc.
405 Barclay Boulevard
Lincolnshire, Illinois 60069
Tel: 1 847 955 8200
Toll Free: 1 800 444 9935
www.honeywellanalytics.com
detectgas@honeywell.com

Product Registration

<http://www.honeywellanalytics.com>

WEEE and RoHS Directives

<http://www.honeywellanalytics.com>

Table of Contents

<i>Limited Warranty and Limitation of Liability</i>	3
<i>Contacting Honeywell Analytics</i>	4
<i>Product Registration</i>	4
<i>WEEE and RoHS Directives</i>	4
<i>Introduction</i>	9
<i>Safety Information - Read First</i>	9
<i>International Symbols</i>	11
<i>Getting Started</i>	13
<i>Activating the Detector</i>	15
<i>Self-Test</i>	15
Datalogging Unit.....	16
Pump Test.....	17
Due-Lock Enabled.....	18
Force Calibration Enabled.....	19
Bump Daily Enabled.....	19
<i>Self-Test Pass</i>	20
<i>Self Test Fail</i>	21
<i>Battery Test</i>	21
<i>Datalogger Operation</i>	21
<i>Deactivating the Detector</i>	21
<i>User Options Menu</i>	22
<i>Exit User Options Menu</i>	23
<i>Options Menu</i>	23
Backlight.....	23
Confidence Beep.....	23
Due-Lock.....	23
Latched Alarms.....	24
Passcode Protect.....	24
Safe Display.....	24
<i>Sensor Configuration</i>	25
Sensor Enable/Disable.....	26
Span Gas Value.....	27
STEL Period.....	27
TWA Method.....	28
Resolution.....	28
%Vol CO ₂	29
%Vol CH ₄	29
Correction Factor (CF).....	30
LEL Sensor.....	30
PID Sensor.....	30
Automatic Oxygen (O ₂) Calibration.....	31
<i>Logger Option</i>	31

<u>Clock Option</u>	32
<u>Language Selection</u>	32
<u>Tech Mode</u>	33
Sensors.....	34
Pump.....	34
Initialize.....	35
Force Calibration.....	36
Bump Daily.....	36
Stealth Mode.....	37
IR Stealth Mode.....	37
<u>Alarms</u>	38
<u>Gas Exposures Computed</u>	39
<u>Viewing Gas Exposures</u>	40
<u>Clearing Gas Exposures</u>	40
<u>Gas Alarm Setpoints</u>	41
<u>Viewing the Alarm Setpoints</u>	41
<u>Resetting Gas Alarm Setpoints</u>	42
<u>Stopping a Gas Alarm</u>	42
<u>Sensor Alarm</u>	43
<u>Pump Alarm</u>	43
<u>Low Battery Alarm</u>	43
<u>Automatic Deactivation Alarm</u>	43
<u>Calibration and Setting Alarm Setpoints</u>	44
<u>Guidelines</u>	44
Diagnostics Protection.....	45
<u>Applying Gas to the Sensors</u>	45
Single Gas Calibration Cap.....	46
Removing the Single Gas Calibration Cap.....	47
<u>Calibration Procedure</u>	47
Start Calibration.....	47
Auto Zero and Oxygen (O ₂) Sensor Calibration.....	48
Zero CO ₂	48
Passcode Protect Activated.....	49
Auto Span.....	50
Apply Span Gas Now.....	50
Select Sensor.....	52
Skip Calibration.....	52
Successful Span.....	52
Unsuccessful Span.....	53
Failed Span.....	53
No Gas Detected.....	54
Did Not Reach Target Span.....	54
Large Span.....	54
Setting the Calibration Due Date.....	55

Alarm Setpoints	56
Setting the TWA Alarm Setpoint	57
Setting the STEL Alarm Setpoint	57
Setting the Low Alarm Setpoint	57
Setting the High Alarm Setpoint	57
Setting the Remaining Alarm Setpoints	58
Finish Calibration	58
Verification	58
<i>Attaching the Accessories</i>	<i>59</i>
<i>Installing the Pump Module</i>	<i>59</i>
<i>Attaching the Sample Probe</i>	<i>60</i>
<i>Replacing the Pump Auxiliary Filter.....</i>	<i>61</i>
Installing the Filter.....	61
<i>Datalogger.....</i>	<i>61</i>
<i>Datalog.....</i>	<i>62</i>
<i>MMC Card Compatibility.....</i>	<i>62</i>
<i>Inserting the MMC Card.....</i>	<i>63</i>
<i>MMC Card Troubleshooting.....</i>	<i>64</i>
<i>Restoring Datalog Files.....</i>	<i>64</i>
<i>Reformatting the MMC Card.....</i>	<i>65</i>
<i>Viewing Datalog Files.....</i>	<i>66</i>
Example of a Datalog.....	66
<i>Maintenance.....</i>	<i>71</i>
<i>Replacing/Charging the Batteries</i>	<i>71</i>
<i>Battery Pack.....</i>	<i>72</i>
<i>Replacing the Battery Pack Latch</i>	<i>72</i>
<i>Replacing a Sensor or Sensor Filter</i>	<i>73</i>
<i>Photoionization Detector (PID)</i>	<i>74</i>
Clean or Replace the Lamp	74
Replace the Lamp.....	75
Replace the Electrode Stack.....	75
<i>Troubleshooting</i>	<i>76</i>
<i>Replacement Parts and Accessories</i>	<i>79</i>
<i>Specifications</i>	<i>81</i>
<i>General Specifications for Datalogger Units.....</i>	<i>84</i>
<i>X5 with User Downloadable Datalogger</i>	<i>84</i>
<i>Appendix A</i>	<i>85</i>
<i>PID Correction Factor (CF) Library.....</i>	<i>85</i>
<i>Other PID Gases.....</i>	<i>85</i>



Introduction

WARNING

To ensure your personal safety, read “Safety Information” before using the detector.

The X5 gas detector (“the detector”) warns of hazardous gas at levels above user-selectable alarm setpoints.

The detector is a personal safety device. It is your responsibility to respond properly to the alarms.

Table 1 lists the gases monitored.

Gas Detected	Unit of Measure
Oxygen (O ₂)	percent by volume (%)
Combustible gases field selectable for:	a) percent of lower explosive limit (% LEL) b) percent by volume methane 0-5.0% v/v
Carbon monoxide (CO)	parts per million (ppm)
Hydrogen sulfide (H ₂ S)	parts per million (ppm)
Phosphine (PH ₃)	parts per million (ppm)
Sulfur dioxide (SO ₂)	parts per million (ppm)
Chlorine (Cl ₂)	parts per million (ppm)
Ammonia (NH ₃)	parts per million (ppm)
Nitrogen dioxide (NO ₂)	parts per million (ppm)
Hydrogen cyanide (HCN)	parts per million (ppm)
Chlorine dioxide (ClO ₂)	parts per million (ppm)
Ozone (O ₃)	parts per million (ppm)
Volatile organic compounds (VOC)	parts per million (ppm)
Carbon dioxide (CO ₂)	parts per million (ppm) or % vol CO ₂

Table 1. Gases Monitored

Safety Information - Read First

Use the detector only as specified in this manual, otherwise the protection provided by the detector may be impaired.

International symbols used on the detector and in this manual are explained in [Table 2](#).

Read the **Warnings** and **Cautions** on the following pages before using the detector.

NOTE

This instrument contains batteries. Do not mix with the solid waste stream. Spent batteries should be disposed of by a qualified recycler or hazardous materials handler.

 **CAUTIONS**

- » For safety reasons, this equipment must be operated and serviced by qualified personnel only. Read and understand the user manual completely before operating or servicing.
- » Do not use the detector if it is damaged. Before using the detector, inspect the case. Look for cracks and/or missing parts.
- » If the detector is damaged or parts are missing, contact your local Distributor or Honeywell Analytics immediately.
- » Use only sensor(s) that are specifically designed for the X5 PID/IR. Refer to [Replacement Parts and Accessories](#).
- » Calibrate the detector before first-time use and then on a regular schedule, depending on use and sensor exposure to poisons and contaminants. HA recommends at least once every 180 days (6 months).
- » To maintain optimal accuracy, the detector should be periodically supplied with a known concentration test gas (bump test) and if the readings are outside of 15% of the applied gas concentration, a span calibration should be performed, under conditions of standard temperature (15°C to 25°C/59°F to 77°F), humidity and pressure. Follow local regulations and/or your company's policy on the frequency of bump testing. For more information on test gas, contact your local Honeywell Analytics Distributor.
- » HA recommends to “bump test” the sensors before each days use to confirm their ability and response to gas by exposing the detector to a gas concentration that exceeds the high alarm setpoints. Manually verify that the audible and visual alarms are activated. Calibrate if the readings are not within the specified limits.
- » It is recommended that the combustible sensor be checked with a known concentration of calibration gas after any known exposure to contaminants/poisons (sulfur compounds, silicon vapors, halogenated compounds, etc.).
- » The combustible sensor is factory calibrated to 50% LEL methane. If monitoring a different combustible gas in the % LEL range, calibrate the sensor using the appropriate gas. High off-scale % LEL or % v/v methane readings may indicate an explosive concentration.
- » Only the combustible gas detection portion of this instrument has been assessed for performance by CSA International.
- » Protect the combustible sensor from exposure to lead compounds, silicones, and chlorinated hydrocarbons. Although certain organic vapors (such as leaded gasoline and halogenated hydrocarbons) may temporarily inhibit sensor performance, in most cases, the sensor will recover after calibration.
- » Any rapid up-scaling reading followed by a declining or erratic reading can indicate a gas concentration beyond upper scale limit, which may be hazardous.
- » Use only recommended AA alkaline or Lithium-Ion Polymer batteries that are properly charged and installed in the detector case. Refer to Replacement Parts and Accessories.
- » Charge Lithium-Ion Polymer batteries using the recommended charger only. Do not use any other charger. Failure to adhere to this precaution can lead to fire and/or explosion.
- » Protect the PID sensor from exposure to silicone vapors.

- » Read and adhere to all instructions and precautions in the user manual provided with the charger. Failure to do so can result in fire, electric shock, personal injury, and/or property damage.
- » Extended exposure of the X5 to certain concentrations of combustible gases and air may stress a detector element that can seriously affect its performance. If an alarm occurs due to high concentration of combustible gases recalibrate the sensor, or if required, replace the sensor.
- » Do not test the combustible sensor response with a butane cigarette lighter; doing so will damage the sensor.
- » Do not expose the detector to electrical shock or severe continuous mechanical shock.
- » When calibrating O₂ and ClO₂ sensors that are located in the Toxic 2 sensor position, a single gas calibration cap must be used to ensure accurate calibration. For more information, refer to [Single Gas Calibration Cap](#).
- » Do not immerse the detector in liquids.
- » Do not attempt to disassemble, adjust, or service the detector unless instructions for that procedure are provided in the manual and/or that part is listed as a replacement part. Use only Honeywell Analytics Replacement Parts and Accessories.
- » The detector warranty will be voided if customer, personnel, or third parties damage the detector during repair attempts. Non-Honeywell Analytics repair/service attempts void this warranty.



WARNING

Substitution of components may impair Intrinsic Safety.

International Symbols

Symbol	Meaning
	Classified to both U.S. and Canadian Safety standards by the Canadian Standards Association.
	Conforms to European Union Directives
	European Explosives Protection
ATEX	Conforms to European ATEX Directives
IECEx	International Electrotechnical Commission Scheme for Certification to Standards for Electrical Equipment for Explosive Atmospheres

Table 2. International Symbols

Getting Started

The list below provides the standard items included with the detector. If the detector is damaged or parts are missing, contact the place of purchase immediately.

- Batteries: three replaceable alkaline cells or one rechargeable battery pack.
- Sensors: O₂, combustible (LEL), toxic, H₂S/CO (TwinTox sensor), PID, or CO₂
- Calibration cap and hose
- Single gas calibration cap
- Phillips/hex Screwdriver
- Quick Start Guide
- Manual CD with Fleet Manager II Software

To order replacement parts, refer to [Replacement Parts and Accessories](#).

The detector is shipped with sensors and alkaline batteries installed. To replace the sensors and batteries, refer to [Maintenance](#).

To become oriented with the features and functions of the detector, refer to the following figures and tables:

- Figure 1 and Table 3 describes the detector components
- Figure 2 and Table 4 describes the detector Liquid Crystal Display (LCD) elements
- Table 5 describes the detector pushbuttons

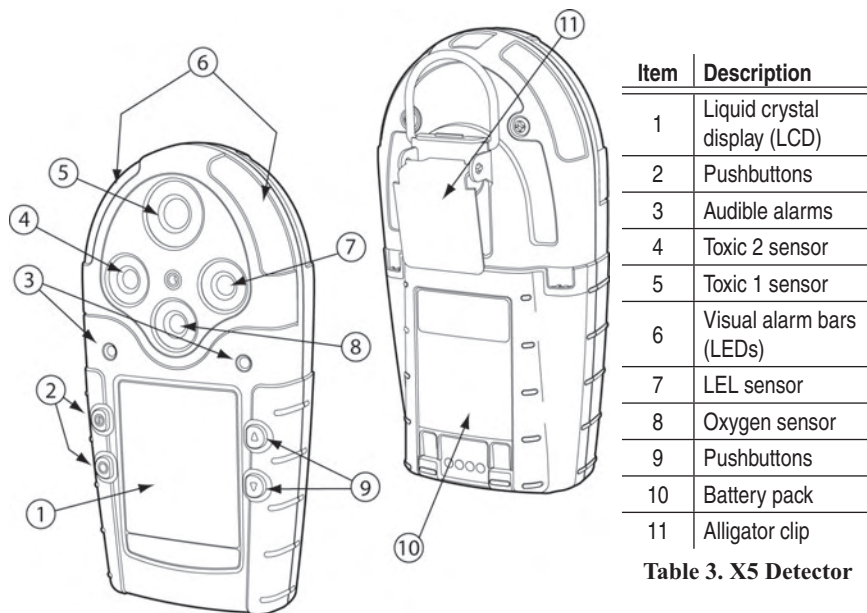

Figure 1. X5 Detector

Item	Description
1	Liquid crystal display (LCD)
2	Pushbuttons
3	Audible alarms
4	Toxic 2 sensor
5	Toxic 1 sensor
6	Visual alarm bars (LEDs)
7	LEL sensor
8	Oxygen sensor
9	Pushbuttons
10	Battery pack
11	Alligator clip

Table 3. X5 Detector

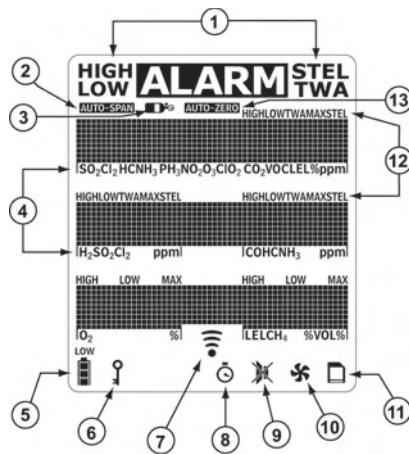

Figure 2. Display Elements

Item	Description
1	Alarm condition
2	Automatically span sensor
3	Gas cylinder
4	Gas identifier bars
5	Battery life indicator
6	Passcode lock
7	Data transmission
8	Clock
9	Stealth mode
10	Optional pump indicator
11	Optional datalog card indicator
12	Alarm condition (low, high, TWA, STEL, or multi-gas) or view TWA, STEL, and maximum (MAX) gas exposures
13	Automatically zero sensor

Table 4. Display Elements

NOTE

If enabled, the backlight automatically activates for 8 seconds when there is an alarm condition and whenever there is insufficient light to view the LCD. Any pushbutton reactivates the backlight in low light conditions.

Pushbutton	Description
	To activate the detector press . To deactivate the detector, press and hold until the countdown is complete (from normal operation only).
	To increment the displayed value or scroll up, press . To enter the user options menu, press and simultaneously and hold until the countdown is complete. To clear the TWA, STEL, and MAX gas exposure readings, press and simultaneously and hold until the countdown is complete. To view the date and time, alarm setpoints (TWA, STEL, low, and high) of all sensors, and the LEL/PID correction factor (if applicable), press .
	To decrement the displayed value or scroll down, press . To initiate calibration and setting alarm setpoints, press and simultaneously and hold until the countdown is complete.
	To view the TWA, STEL, and MAX hold readings, press . To acknowledge latched alarms press .

Table 5. Pushbuttons

Activating the Detector

Attach the pump module and the sampling probe (with hose) prior to activating the detector. For illustrations and procedures, refer to [Attaching the Accessories](#).

To activate the detector, press  in a normal atmosphere (20.9% oxygen).

Self-Test

When the detector is activated, it performs several self-tests. Confirm the following tests occur.

NOTE

If an error message displays during the self-test, refer to [Troubleshooting](#).

The detector performs a battery test during start-up.

If the battery has insufficient power to operate, the following screen displays before deactivating.

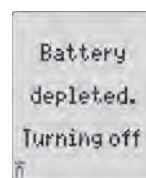

Replace the batteries and reactivate the detector.

1. All of the LCD elements display simultaneously as the detector beeps, flashes, vibrates, and briefly activates the backlight.

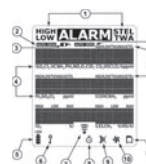

2. The version and serial number of the detector displays.



3. The date and time displays.

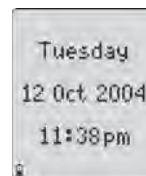

Datalogging Unit

(Optional)

4. If the detector is a datalogging unit, it determines if
 - a Multi-media card (MMC) is inserted,
 - the detector can communicate with the card,
 - the detector supports the size of the card, and
 - the card requires formatting.

NOTE

If there is a problem with the MMC card, Datalogger disabled displays. The detector then automatically continues with the self-test.

If the card requires formatting, the following screen displays as the card is automatically formatted.

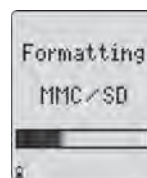

5. The detector then runs a self-test to verify the sensors and power supply.



Self-test Successful: If successful, the following screen displays.

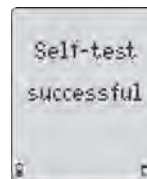

Self-test Unsuccessful: If a sensor fails the self-test, a warning displays indicating which sensor(s) has failed.

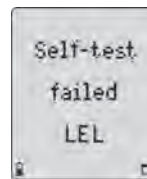

6. If correction factors are set in the user options, the LEL or PID (custom) correction factors display.

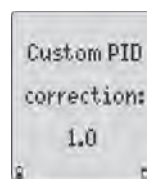
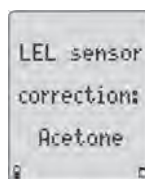

7. The TWA, STEL, low, and high alarm setpoints then display in the following order.

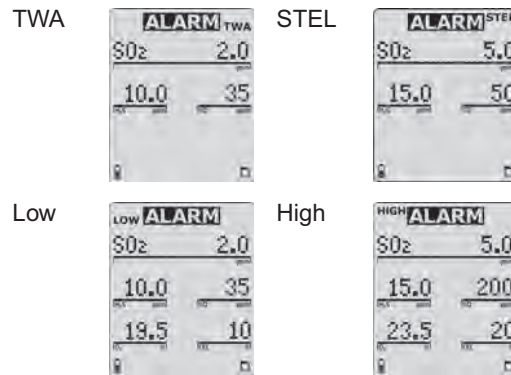

NOTE

The alarm setpoints may vary by region. Refer to [Resetting Gas Alarm Setpoints](#).

Pump Test
(Optional)

8. If the pump module is attached to the detector, the following screens display.

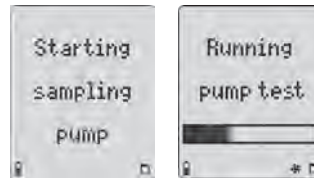

When the following screen displays, block the pump inlet.

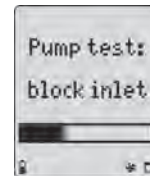

If the pump inlet is not blocked within 10 seconds or the pump test fails, the following screens display.

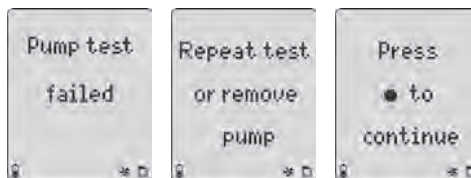

If  is not pressed or the pump is not removed within 25 seconds, the detector performs the pump test again.

If the pump test is successful, the following screen displays and the self-test continues.

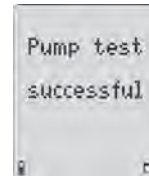

9. Unless disabled in user options, the oxygen (O₂) sensor is calibrated automatically.

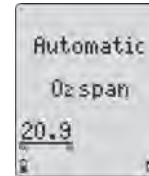

If the span is successful, the detector beeps twice.

NOTE

If the automatic O₂ calibration feature has been disabled, **Automatic O2 span disabled** displays.

10. The number of days remaining before calibration is due displays for all sensors.

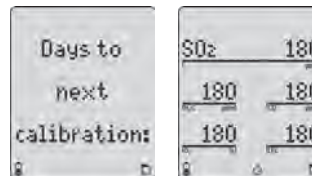

If any sensor is over due for calibration, the name of the sensor and the number of days past due display.

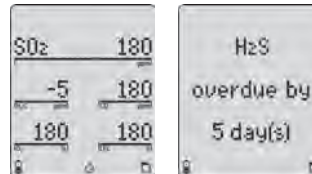

Due-Lock Enabled

The **Due-lock** option ensures that a passcode must be entered when calibration is past due, otherwise the detector automatically deactivates.

11. If Due-Lock is enabled in the user options, the following screen displays.



Enter the correct passcode and press \odot to confirm.

NOTE

If any sensor is overdue, \odot displays continually until calibration is performed.

If no passcode is entered, or it is entered incorrectly, the following screen displays.

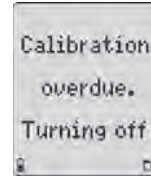

To enable/disable this option, refer to [Due-lock](#) in the user options menu. Also refer to [Passcode Protect](#)

Force Calibration Enabled

12. If **Force cal** (force calibration) is enabled in tech mode, calibration is mandatory before the detector enters normal operation.

Refer to [Force Calibration](#) in Tech Mode to enable/disable, and refer to [Calibration and Setting Alarm Setpoints](#) for calibration procedures.

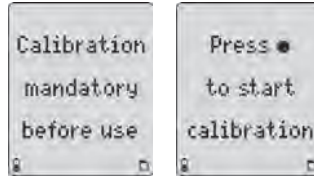

If is not pressed to start calibration, the following screen displays and the detector deactivates.

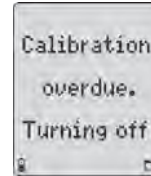

Bump Daily Enabled

CAUTION

Honeywell Analytics recommends that a bump test of all sensors be performed every 24 hours prior to the beginning of the work shift.

13. If **Bmp Daily** (bump daily) is enabled in tech mode, the following screens display.

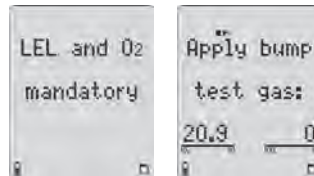

If a bump test of the LEL and O₂ sensor is not performed, the detector will deactivate.

Apply the LEL gas and then apply the O₂ (a higher or lower percentage than the default 20.9%).

Successful Bump Test: If the bump test passes, the following screens display.

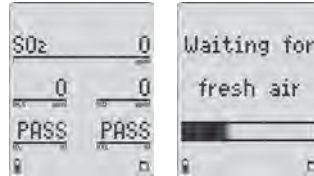

The detector waits for the sensor(s) to clear (approximately 30 seconds) and then enters normal operation.

Unsuccessful Bump Test: If the bump test is unsuccessful or the bump test is not performed, the following screen displays and the detector deactivates.

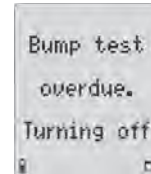

14. If additional sensors require a bump test but are not mandatory, the following screens display.

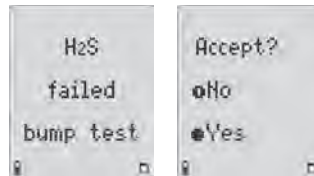

Press **Yes** to accept and proceed to normal operation.

Or

If **No** is pressed, or no buttons are pressed, the sensor(s) that are past due display as **FAIL** when the detector enters normal operation. In the following screen example, only the SO₂, CO, and O₂ sensors are operational.

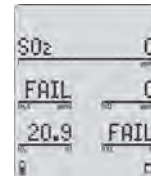

The self-test is now complete.

Self-Test Pass

If the detector passes the self-test, it enters normal operation and displays the ambient gas readings.

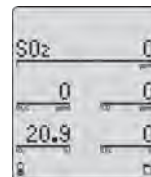

The detector begins recording the maximum gas exposure (MAX) and calculating the short-term exposure level (STEL) and time-weighted average (TWA) exposures.

Self Test Fail

If a sensor fails, **FAIL** flashes above that sensor on the normal operation screen. For possible problems and solutions, refer to [Troubleshooting](#).

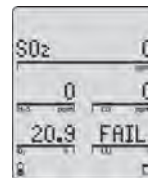

Battery Test

The batteries are tested when the detector is activated and continuously thereafter. The battery power icon displays continually during normal operation. If battery power is low,  flashes.

Datalogger Operation

(Optional)



Do not remove the battery pack while the detector is activated. Doing so will prevent the datalogger from logging correctly.

Datalogger operation is automatic and requires no settings. During normal operation the card is tested every 20 seconds.

NOTE

The MMC card icon () displays continuously on datalogger detectors when the card is inserted. The card is not required for operation of a detector equipped with datalogging; however, if the card is not inserted, the detector will not record data.

NOTE

To maintain optimal accuracy, the detector should be periodically supplied with a known concentration test gas (bump test) and if the readings are outside of 15% of the applied gas concentration, a span calibration should be performed, under conditions of standard temperature (15°C to 25°C/59°F to 77°F), humidity and pressure. Follow local regulations and/or your company's policy on the frequency of bump testing. For more information on test gas, contact your local Honeywell Analytics Distributor.

Deactivating the Detector

To deactivate the detector, press and hold  while it beeps and flashes to the corresponding countdown.

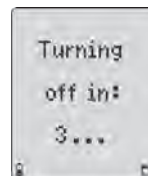

At the end of the countdown the detector emits an extended beep and flash, and displays **0** before deactivating.

NOTE

If  is not held down for the complete countdown, the detector remains activated.

User Options Menu

If the detector is passcode protected, a passcode must be entered to access the user options menu. For more information, refer to [Passcode Protect](#).

The available user options are as follows:

1. Exit
2. Options: backlight, confidence beep, due-lock, latch, passcode, and safe.
3. Sensors: sensor enable/disable, span gas, STEL period, TWA method, resolution, % vol CH₄, correction factor, automatic O₂ calibration, and % vol CO₂, (applicable only to CO₂).
4. Logger
5. Clock
6. Language: English, French, German, Spanish, and Portuguese.
7. Tech mode: sensors, pump, initialize, forced calibration, daily bump test, stealth, IR stealth (factory option), and zero level (CO₂ sensor only).

NOTE

Tech mode is not visible in the user options menu. To access this option, refer to [Tech Mode](#).

1. To enter the user options menu, press and hold ▲ and ▼ simultaneously as the detector beeps and flashes to the corresponding countdown.

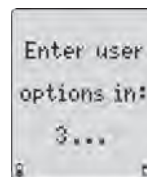

▲ and ▼ must be held down for the entire countdown to access the user options menu.

When the countdown is complete, the revision/serial number screen displays followed by the options menu.

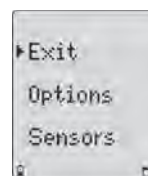

2. To scroll through the options, press ▼ or ▲. When the cursor displays beside the desired option, press ○.
3. To return to the previous menu, scroll to **Back** and press ○ or press ⊙.

NOTE

If no pushbuttons are pressed for 20 seconds, the detector returns to normal operation.

Exit User Options Menu

To exit the user options menu and return to normal operation, scroll to **Exit** and press \odot . The following screen displays.

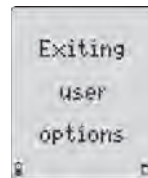

The user options menu can also be exited by repeatedly pressing \odot until the detector returns to normal operation.

Options Menu

Each feature within the **Options** menu is enabled/disabled by pressing \odot to toggle the checkbox.

Enabled

Disabled

Backlight

The backlight (**Backlight**) option enables the LCD backlight to activate automatically in low-light conditions.

If disabled, the backlight activates only when the detector is in alarm mode.

In stealth or IR stealth mode, the backlight does not activate.

The detector is shipped with the backlight option enabled.

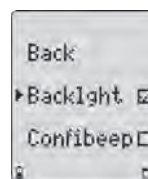

Confidence Beep

The confidence beep (**Confibeep**) option provides continuous confirmation that the detector is operating properly. When confidence beep is enabled, the audible alarm beeps once every 10 seconds.

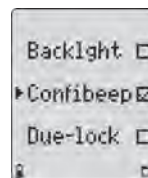

The detector is shipped with the confidence beep option disabled.

Due-Lock

If the calibration user lockout (**Due-lock**) option is enabled and a sensor is overdue for calibration upon start-up, the passcode must be entered to access normal operation.

If the correct passcode is not entered, the detector deactivates.

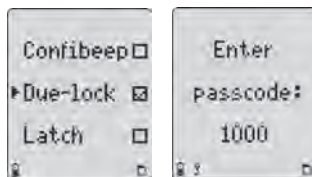

The detector is shipped with the due-lock option disabled.

Latched Alarms

If enabled, the latched alarms (**Latch**) option causes the low and high gas alarms (audible, visual, and vibrator) to persist until they are acknowledged. Press \bigcirc to acknowledge the alarm.

After the alarm is acknowledged, it reactivates every 30 seconds until the gas concentration is below the setpoint.

The detector is shipped with the latch option disabled.

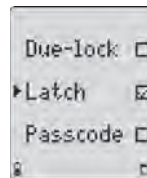

Passcode Protect

The passcode option prevents unauthorized access to the user options menu, the calibration function, and to adjusting the alarm setpoints.

NOTE

The passcode is provided separately.

If passcode protect is enabled and the **Enter passcode: 1000** screen displays, press \blacktriangle or \blacktriangledown to scroll to the correct passcode and then press \bigcirc to confirm.

The detector is shipped with the passcode protect option disabled.

If an incorrect passcode is entered or \bigcirc is not pressed within 5 seconds to confirm the correct passcode, Passcode incorrect displays. The alarm beeps three times and the detector either resumes normal operation or deactivates.

Safe Display

When enabled, the safe option confirms that normal ambient conditions prevail and there are no gas hazards present. When all gas levels are normal or below the alarm setpoints, **Safe** displays continually on the LCD.

The detector is shipped with the safe option disabled.

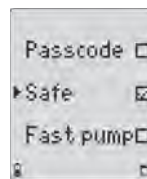
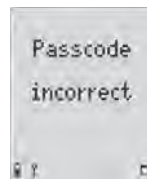
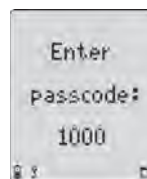
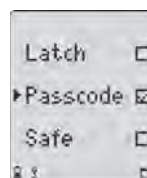

Sensor Configuration



The **Sensor** option provides access to additional options and functions for each sensor.

Depending upon the sensor that is selected, some or all of the following options are available for configuration:

- enabling/disabling a sensor
- setting the span gas value
- adjusting the STEL period (not applicable to LEL and O₂ sensors)
- selecting the TWA method (not applicable to LEL and O₂ sensors)
- resolution setting (not applicable to CO, LEL, O₂, and CO₂ sensors)
- % vol CO₂ (CO₂ sensor only)
- % vol CH₄ (LEL sensor only)
- Selecting the correction factor (LEL and PID sensors only)
- automatic calibration (O₂ sensor only)

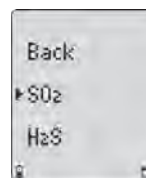
1. From the option menu screen, scroll to **Sensors** and press  to access the following screen.



2. Press  or  to scroll to the desired sensor. Press  to confirm and to access the menu options specific to the selected sensor.

For all sensor options, if a value is changed but not confirmed within 5 seconds, the detector emits an audible alarm and displays the following error message

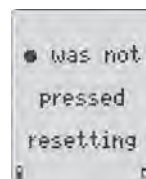

The detector retains the previous setting and returns to the user options menu.

Sensor Enable/Disable

WARNING

Disabling an installed sensor configures the detector to a 1, 2, 3, or 4-gas unit. Protection is no longer provided from the gas targeted by the disabled sensor(s). Disabling a sensor should be performed with extreme caution.

If a sensor fails, disabling the sensor deactivates the fail alarm. The sensor should be replaced and enabled as soon as possible. The detector will function normally with the remaining enabled sensors.

After selecting the desired sensor, the following screen displays.

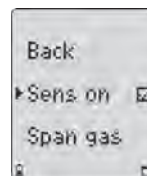

Press to toggle between enable/disable (sensor can be enabled at any time).

Enabled

Disabled

If disabled, the readings for the sensor do not display when in normal operation.

If a sensor is enabled but it is not installed in the detector, **FAIL** flashes above the gas bar of the missing sensor.

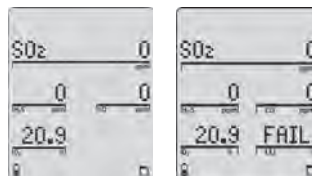

Disabled

Enabled/not installed

If all the sensors are disabled, the following screens display.

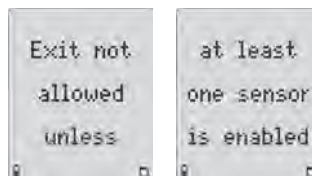

Enable one or more sensors to exit and access normal operation.

Span Gas Value

The **Span gas** option increases or decreases the gas concentration level for calibration (it must match the value on the gas cylinder).

After selecting the sensor, press \blacktriangledown to scroll to **Span gas** and press \bigcirc within 20 seconds to confirm.

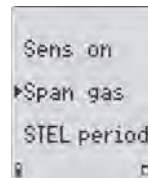

A

Depending upon the sensor selected, a screen similar to **A** or **B** displays. Press \blacktriangle or \blacktriangledown to scroll to the desired value and press \bigcirc within 5 seconds to confirm.

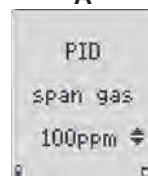

B

If \bigcirc is not pressed within 5 seconds to confirm the new value, the detector retains the previous value and returns to the user options menu.

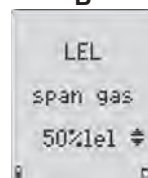

NOTE

Honeywell Analytics recommends that span concentration values be set between specific ranges. Refer to [Calibration and Setting Alarm Setpoints](#).

STEL Period

The short-term exposure limit (**STEL period**) option is available for every toxic sensor.

After selecting the desired sensor, press \blacktriangledown to scroll to **STEL period** and press \bigcirc within 20 seconds to confirm.

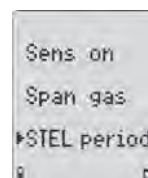

The STEL period can be set from 5 to 15 minutes. Press \blacktriangle or \blacktriangledown to scroll to the required value, and then press \bigcirc within 5 seconds to confirm.

If \bigcirc is not pressed within 5 seconds to confirm the new value, the detector retains the previous value and returns to the user options menu.

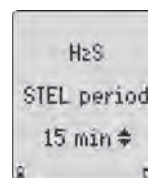

The detector is shipped with the STEL period set to 15 minutes.

TWA Method

The time-weighted average (**TWA method**) option is used to select either the Occupational Safety and Health Administration (OSHA) or the American Conference of Governmental Industrial Hygienists (ACGIH) calculating method.

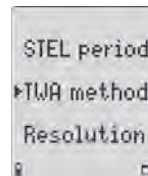

OSHA Method: 8 hour moving average

ACGIH Method: Infinite accumulated average to 8 hours

After selecting the desired sensor, press \blacktriangledown to scroll to **TWA method**. Press \bigcirc within 20 seconds to confirm.

A check displays in the checkbox of the currently selected method. To select the other method, press \blacktriangledown to move the check to other method. Press \bigcirc to confirm the selection.

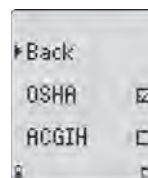

The detector is shipped with the **OSHA** method enabled.

NOTE

If the TWA method has been changed, the TWA, STEL, and MAX peak values must be reset to ensure the TWA is calculated correctly. Refer to [Clearing Gas Exposures](#).

Resolution

This option displays the gas measurement using **Regular** or **Extra** resolution.

Regular: Displays gas measurement in 1 ppm.

Extra: Displays the gas measurement in 0.1 ppm.

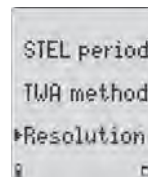

NOTE

Regular resolution for O_3 and ClO_2 sensors is 0.1 ppm, while extra resolution is 0.01 ppm. The **Resolution** option is not available for some sensors.

After selecting the desired sensor, press \blacktriangledown to scroll to **Resolution**. Press \bigcirc within 20 seconds to confirm.

A check displays in the checkbox of the currently selected resolution. To select the other resolution, press \blacktriangledown to move the check to other resolution. Press \bigcirc to confirm the selection.

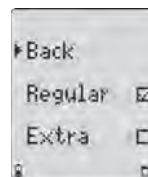

The detector is shipped with **Regular** resolution enabled.

%Vol CO₂
(CO₂ Sensors Only)

If the **%vol CO₂** is enabled, the detector displays the carbon dioxide (CO₂) readings as %vol (**0.0**).

From the Sensors option menu, select **CO₂**.

Press \blacktriangledown to scroll to **%vol CO₂**. Press \bigcirc to toggle between enable and disable.

Confirmation is not required. If no buttons are pushed, after 20 seconds the detector returns to the sensor selection screen. The change is saved automatically.

The detector is shipped with **%vol CO₂** disabled.

NOTE

The correction factor function is not applicable to the IR CO₂ sensor.

%Vol CH₄
(LEL Sensors Only)

If **%vol CH₄** is enabled, any currently enabled correction factor is ignored and the detector operates assuming a methane (CH₄) calibration.

After selecting the LEL sensor, press \blacktriangledown to scroll to **%vol CH₄**. Press \bigcirc within 20 seconds to confirm.

Press \bigcirc to toggle between enable and disable.

Confirmation is not required. If no buttons are pushed, after 20 seconds the detector returns to the sensor selection screen. The change is saved automatically.

The detector is shipped with **%vol CH₄** disabled.

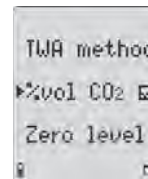
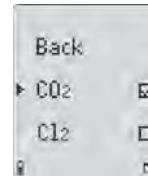

Enabled
Disabled

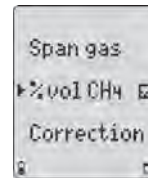
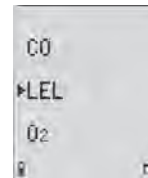

Enabled
Disabled

Correction Factor (CF)

Depending upon the selected sensor, refer to the following sections LEL or PID Sensors for more information. Correction factors are not applicable to CO₂ IR sensors.

LEL Sensor

This option is used to enter compensation factors for hydrocarbons other than methane. The factor can only be applied if the LEL sensor has been calibrated with methane.

After selecting the **LEL** sensor, press \blacktriangledown to scroll to **Correction**. Press \bigcirc within 20 seconds to confirm and access the LEL correction library.

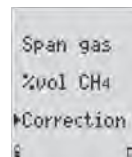

Scroll to the required gas type and press \bigcirc . A check displays in the corresponding checkbox. The detector automatically applies the correction factor.

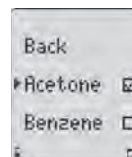

To disable the **Correction** option, press \blacktriangledown to scroll to **None** or to **Methane**. A check displays. If required, select a different gas type correction factor.

Custom: To enter a correction factor that is not listed in the library, scroll to **Custom** and press \bigcirc within 5 seconds to confirm.

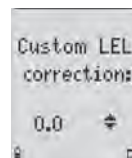

The **Custom LEL correction** screen displays. Press \blacktriangle or \blacktriangledown to select the required value, and press \bigcirc within 5 seconds to confirm.

PID Sensor

This option is used to enter compensation factors for selected gas types. The factor can only be applied if the PID sensor has been calibrated with isobutylene.

After selecting the **PID** sensor, press \blacktriangledown to scroll to **Correction**. Press \bigcirc within 20 seconds to confirm and access the PID correction library.

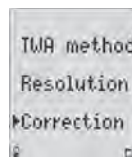

Scroll to the required gas type and press \bigcirc . A check displays in the corresponding checkbox. The detector automatically applies the correction factor.

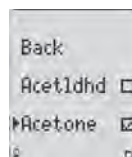

To disable the **Correction** option, press \blacktriangledown to scroll to **None** or to **Isobutyl**. A check displays. If required, select a different gas type correction factor.

Custom: To enter a correction factor for a custom PID sensor, scroll to **Custom** and press \bigcirc . Press \blacktriangle or \blacktriangledown to scroll to the required value, and press \bigcirc within 5 seconds to confirm. Refer to [Appendix A PID Correction Factor Library](#) for gas types and corresponding correction factor values.

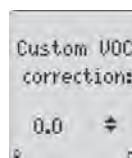

CAUTION

Adding a correction factor to the PID sensor does not change the Alarm Setpoints for the custom gas. Ensure that the proper Alarm Setpoint values for your application are set before using the detector.

Automatic Oxygen (O₂) Calibration

When the **Autocal** option is enabled, it forces the detector to automatically calibrate the oxygen sensor during start-up.

If the **Autocal** option is enabled, ensure the detector is activated in a clean atmosphere only.

From the Sensor menu, press ▼ to scroll to O₂ and press ○ within 20 seconds to confirm.

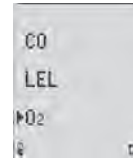

Press ▼ to scroll to **Autocal**. Press ○ to toggle between enable/disable.

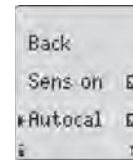

Enabled

Disabled

The detector is shipped with the **Autocal** option enabled.

Logger Option

This option is used to set how often the detector records a datalog sample (once every 1 to 127 seconds).

From the user options menu, press ▼ to scroll to **Logger**. Press ○ within 20 seconds to confirm.



Press ▲ or ▼ to change the current logger rate. When the desired value displays, press ○ within 5 seconds to confirm the new value.

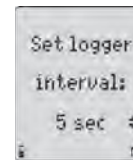

If ○ is not pressed within 5 seconds, the following screen displays.

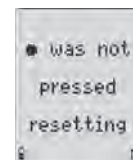

The detector is shipped with the datalogger interval set to 5 seconds.

Clock Option

The **Clock** option is used to change the date and time.

From the user options menu, press ▼ to scroll to **Clock**. Press ○ within 20 seconds to confirm.



The screen displays showing the month highlighted indicating it is selected to set.

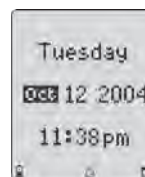

Press ▲ or ▼ to scroll to the desired month and press ○ within 20 seconds to confirm. Continue setting the remaining options.

The date/time options are set as follows:

- month
- day
- year
- hour
- minutes

To bypass and retain the current setting, press ○.

When the settings are complete, the detector beeps twice and returns to the user options menu.

The detector is shipped with the date and time set to factory default time zone.

Language Selection

The detector is shipped with English selected as the default language. The available languages to select from are as follows:

- French (**Français**)
- German (**Deutsch**)
- Spanish (**Español**)
- Portuguese (**Prtuguês**)

Press ▼ to scroll to **Language** and press ○ within 20 seconds to confirm.



Press ▲ or ▼ to scroll to the desired language and press ○. A check displays in the checkbox of the selected language.



Wait for 20 seconds until the detector returns to the user options menu, or press ▲ to scroll to **Back** (English), **Retour** (French), **Zurück** (German), **Regreso** (Spanish), or **Retornar** (Portuguese).

All the screens now display in the selected language.

Tech Mode



WARNING

Tech mode should only be accessed by authorized personnel.

Tech mode can only be accessed from the **Language** option. Press ▼ to scroll to **Language**. Do not press ○ until instructed.



In the following order, press and continue to hold each button until **Tech mode** displays.

1. Press and hold ▼.
2. Press and hold ▲.
3. Press and hold ○.

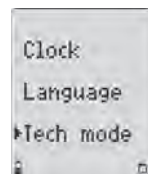

Press ○ to enter **Tech mode**. The options are as follows:

- **Sensors**
- **Pump**
- **Initialize**
- Force calibration (**Force cal**)
- Bump test daily (**Bmp daily**)
- Stealth mode (**Stealth**)
- IR Stealth mode (**IR Stlth**) / optional feature

Sensors

CAUTION

Physically change the sensor prior to entering Tech mode to reconfigure the sensor type.



When a toxic sensor is physically removed and replaced by another toxic sensor, the detector must be reconfigured to recognize the change.

NOTE

If a sensor is replaced, the detector will classify the sensor as overdue for calibration. Calibrate the new sensor immediately.

1. Press  to scroll to **Sensors**. Press  within 20 seconds to confirm and access the toxic sensor menu.



2. Press  or  to scroll to **Toxic 1** or **Toxic 2** and press  within 20 seconds to confirm.

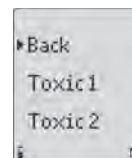

A corresponding list of toxic sensors displays. A checkbox displays beside the current toxic sensor.



NOTE

Toxic 1: List includes the PID and CO₂ sensors.

Toxic 2: List includes the H₂S/CO COSH sensor.

3. Press  or  to scroll to the new sensor and press  to confirm. A checkbox displays beside the new sensor. To reconfigure, exit the user options menu.

The following screen displays. The detector deactivates and immediately reactivates. It performs the reconfiguration during the start-up.

The new sensor must also be calibrated as the calibration information returns to the default settings, and the due date automatically displays as **OL** (over limit) while in normal operation.

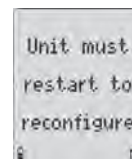

Pump

(Optional Accessory)

WARNING

Use only the pump that is provided with the detector. Do not exchange pump modules between detectors.

If the detector has been purchased with the pump, the settings do not need to be adjusted. If attaching a new pump module to the detector, the flow rate must be set prior to using the pump.

1. If required, refer to [Installing the Pump Module](#). Press \blacktriangledown to scroll to **Pump** and press \bigcirc within 20 seconds to confirm.

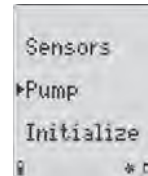

2. Press \blacktriangle and \blacktriangledown to scroll to the required factory-calibrated value (as provided by HA). When the value displays, press \bigcirc within 5 seconds to confirm.

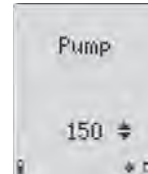

After selecting a new flow rate, a pump test must be performed.

3. Exit the user options menu. The detector automatically launches the pump test before returning to normal operation mode.

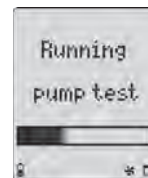

Refer to [Pump Test](#) for additional information.

Initialize

The **Initialize** option restores the original factory default settings of the detector.

1. Press \blacktriangledown to scroll to **Initialize** and press \bigcirc within 20 seconds to confirm.

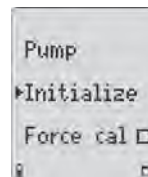

2. From the **Initialize?** screen, within 5 seconds
 - press \textcircled{N} **No** to exit, or
 - press \bigcirc **Yes** to initialize.

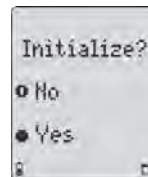

If **No** is selected, the following screen displays and the detector exits the initialize option.

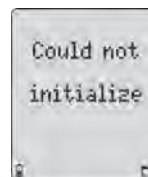

If **Yes** is selected, the following screen displays while performing the initializing process.

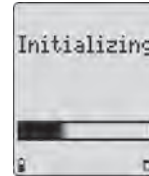

When initializing is complete, the following screen displays.

The detector deactivates and then immediately reactivates. The detector then reconfigures to the default settings while it performs the self-test.

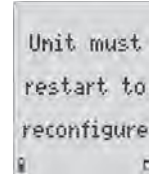

Verify all settings and alarm setpoints, and then calibrate the sensors.

Force Calibration

If enabled, the **Force cal** option automatically forces the detector to enter calibration if a sensor is overdue upon start-up. Press \blacktriangledown to scroll to **Force cal**.

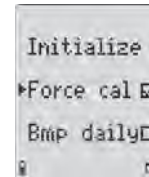

Press \bigcirc to toggle between enable/disable.

The detector is shipped with the **Force cal** option disabled.

Bump Daily

If enabled, the **Bmp daily** option forces the detector to perform a daily bump test to ensure that it is responding to the test gas.

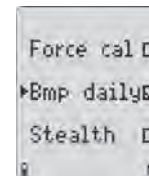

Press \blacktriangledown to scroll to **Bmp daily**. Press \bigcirc to toggle between enable/disable.

When enabled, during start-up the following screen displays.

The bump test must be performed for the LEL and O₂ sensors, otherwise the detector will deactivate. Refer to [Bump Daily Enabled](#) for procedures.

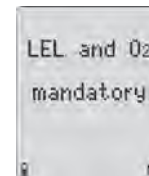

The detector is shipped with the **Bmp daily** option disabled.

NOTE

If **Bmp daily** is enabled, the O₂ and LEL sensors require daily bump tests whenever the detector is activated (or reactivated) following 00:00 hours (midnight).

Stealth Mode

NOTE

The **Stealth** and **IR Stith** cannot be enabled simultaneously.

The **Stealth** option disables the backlight, visual alarms, and audible alarms when concealment is required.

Only the vibrator and the LCD activate during an alarm condition.

Press  to scroll to **Stealth**. Press  to toggle between enable/disable.

The detector is shipped with the **Stealth** option disabled.

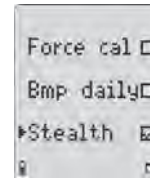

Alarms

The following table describes the detector alarms and corresponding screens.

During an alarm condition, the detector activates the backlight and displays the current ambient gas reading.

If more than one type or level of alarm exists simultaneously, a multi-gas alarm will result.

To change the factory-set alarm setpoints, refer to [Calibration and Setting Alarm Setpoints](#).

Alarm	Display	Alarm	Display
Low Alarm: <ul style="list-style-type: none"> Fast beep Slow flash ALARM and target gas bar flash Vibrator alarm activates 		High Alarm: <ul style="list-style-type: none"> Constant beep Fast flash ALARM and target gas bar flash Vibrator alarm activates 	
STEL Alarm: <ul style="list-style-type: none"> Constant beep Fast flash ALARM and target gas bar flash Vibrator alarm activates 		TWA Alarm: <ul style="list-style-type: none"> Fast beep Slow flash ALARM and target gas bar flash Vibrator alarm activates 	
Multi-Gas Alarm: <ul style="list-style-type: none"> Alternating low and high alarm beep and flash ALARM and target gas bars flash Vibrator alarm activates 		Over Range Alarm: (Over Level Exposure) <ul style="list-style-type: none"> Fast beep and flash ALARM and target gas bar flash Vibrator alarm activates 	
Sensor Alarm: <ul style="list-style-type: none"> One beep every 15 seconds FAIL flashes above the failed sensor 		Automatic Shutdown Alarm: <ul style="list-style-type: none"> Eight beeps and flashes LOW displays Vibrator alarm temporarily activates 	
Low Battery Alarm: <ul style="list-style-type: none"> One beep and two flashes every 25 seconds LOW flashes 		Normal Shutdown: <ul style="list-style-type: none"> Three beeps and flashes 	

Table 6. Alarms







Alarm	Display	Alarm	Display
Confidence Beep: <ul style="list-style-type: none"> Two fast beeps every 10 seconds 		MMC Fail Alarm: <ul style="list-style-type: none"> One beep every 5 seconds  flashes 	
Alarm	Displays		
Pump Alarm: <ul style="list-style-type: none"> Two fast beeps and alternating flashes Vibrator alarm activates ALARM and  flash 			

Table 6. Alarms

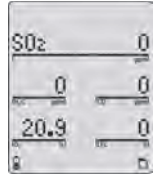
NOTE

If the latched alarm option is activated, the audible and visual alarms continue to beep and flash until the alarm condition is acknowledged. To acknowledge a latched alarm, press . The alarms cannot be deactivated if an alarm condition exists.

If the stealth option is enabled, the detector only vibrates during an alarm; the audible and visual alarms are disabled.

If the IR stealth option is enabled, the detector vibrates and the IR LEDs activate. The audible and non-IR visual alarms are disabled.

Gas Exposures Computed

 **WARNING**

To avoid possible personal injury, do not deactivate the detector during a work shift. TWA and STEL readings reset if the detector is deactivated for more than 5 minutes.

Gas Exposure	Description
TWA (toxic only)	Time-weighted average (TWA) based on accumulated exposure to toxic gases averaged over a work day according to OSHA or ACGIH method.
STEL (toxic only)	Short-term exposure limit (STEL) to gas based on a 5-15 minute user selectable period.
Maximum* (peak)	Maximum (MAX) concentration encountered during work shift.

*For oxygen, it is the highest or the lowest concentration encountered.

Table 7. Computed Gas Exposures

Viewing Gas Exposures

Press and hold  until the **MAX** gas exposures screen displays.

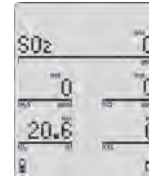

The **TWA** gas exposures display next.





Lastly, the **STEL** gas exposures display.





Clearing Gas Exposures

The exposures automatically clear after 5 minutes of the detector being deactivated.

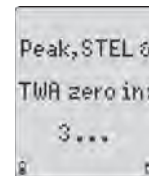
To clear the MAX, TWA, and STEL exposure readings immediately, press and hold  and  simultaneously. The detector displays the following screen during the countdown.



NOTE

Hold  and  for the entire countdown, otherwise the MAX, TWA, and STEL exposure readings will not clear.

Gas Alarm Setpoints

The gas alarm setpoints trigger the gas alarms and are described in Table 8.

Alarm	Condition
Low alarm	Toxics and combustibles: Ambient gas level above low alarm setpoint. Oxygen: Ambient gas level may be set above or below 20.9%.
High alarm	Toxics and combustibles: Ambient gas level above high alarm setpoint. Oxygen: Ambient gas level may be set above or below 20.9%.
TWA alarm	Toxic only: Accumulated value above the TWA alarm setpoint.
STEL alarm	Toxic only: Accumulated value above the STEL alarm setpoint.
Downscale alarm	Toxic: If sensor reading is negative (half of the TWA setpoint). LEL: If sensor reading is negative (half of the low alarm setpoint).
Multi-gas alarm	Two or more gas alarm conditions.

Table 8. Gas Alarm Setpoints

Viewing the Alarm Setpoints

To view the current alarm setpoints for all of the sensors, press Δ during normal operation.

The TWA, STEL, low, and high alarm setpoint screens display in the following order:

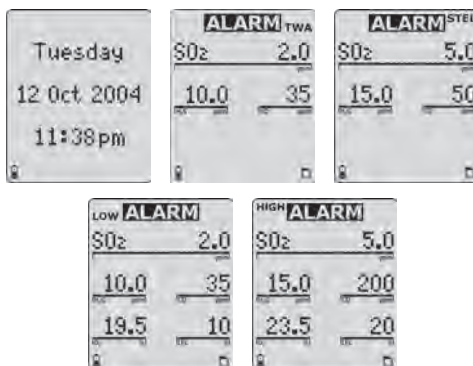

If a correction factor has been applied to a sensor, one of the following screens display indicating the sensor and gas type.

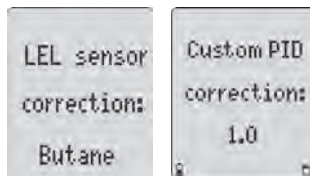

Resetting Gas Alarm Setpoints

NOTE

Standard factory alarm setpoints vary by region.

The following table lists the factory alarm setpoints according to the Occupational Safety and Health Association (OSHA) settings.

Gas	TWA	STEL	Low	High
O ₂	N/A	N/A	19.5% vol.	23.5% vol.
LEL	N/A	N/A	10% LEL	20% LEL
CO	35 ppm	50 ppm	35 ppm	200 ppm
H ₂ S	10 ppm	15 ppm	10 ppm	15 ppm
PH ₃	0.3 ppm	1.0 ppm	0.3 ppm	1.0 ppm
SO ₂	2 ppm	5 ppm	2 ppm	5 ppm
Cl ₂	0.5 ppm	1.0 ppm	0.5 ppm	1.0 ppm
NH ₃	25 ppm	35 ppm	25 ppm	50 ppm
NO ₂	2.0 ppm	5.0 ppm	2.0 ppm	5.0 ppm
HCN	4.7 ppm	10.0 ppm	4.7 ppm	10.0 ppm
ClO ₂	0.1 ppm	0.3 ppm	0.1 ppm	0.3 ppm
O ₃	0.1 ppm	0.1 ppm	0.1 ppm	0.1 ppm
VOC	50 ppm	100 ppm	50 ppm	100 ppm
CO ₂	5,000 ppm	30,000 ppm	5,000 ppm	30,000 ppm

Table 9. OSHA Sample Factory Alarm Setpoints

To change the factory-set alarm setpoints, refer to [Calibration and Setting Alarm Setpoints](#).

NOTE

To disable an alarm, set the alarm setpoint to **0** (zero).

Stopping a Gas Alarm

The low and high alarms stop when the ambient gas level returns to below the low alarm setpoint.

NOTE

If alarms are set to latch, press  to reset the alarms.

The TWA and STEL alarms can be stopped either by

- clearing the MAX, TWA, and STEL peak exposures (refer to [Clearing Gas Exposures](#)), or
- deactivating the detector for 5 minutes (minimum) and then reactivating it again.



CAUTION

Follow all safety procedures as defined by your employer. Confirm with your supervisor before clearing TWA and STEL alarms.

Sensor Alarm

The detector tests for missing or defective sensors during the activation self-test. If a sensor fails the self-test, **FAIL** flashes on the LCD above the failed sensor. Refer to [Troubleshooting](#).



Pump Alarm

The external pump draws air over the sensors continually. If the pump stops operating or becomes blocked, the detector activates the pump alarm. The following screens display.

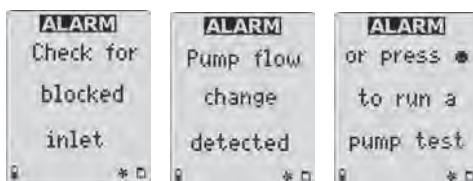

The pump alarm continues until the blockage is cleared or it is acknowledged by pressing \circ . If \circ is pressed, the detector automatically launches a pump test to reset the pump module.

Refer to [Pump Test](#) for more information. If the pump test is successful, the detector returns to normal operation, otherwise the pump alarm continues.

Low Battery Alarm

The detector tests the batteries upon activation and continuously thereafter. Battery power is continually displayed during normal operation. If the battery voltage is low, the detector activates the low battery alarm.

The low battery alarm continues until the batteries are replaced/charged, or until the battery power is almost depleted. If the battery voltage becomes too low, the detector deactivates.

NOTE

Typically, the low battery alarm continues for 30 minutes before the detector automatically deactivates.

Automatic Deactivation Alarm

If the battery voltage is in immediate danger of falling below the minimum operating voltage, the audible alarm beeps eight times and the visual alarm flashes eight times. After 3 seconds, the LCD dims and the detector deactivates.

To replace or charge the batteries, refer to [Replacing/Charging the Batteries](#).

Calibration and Setting Alarm Setpoints

Guidelines

When calibrating the detector, adhere to the following guidelines:

- Recommended gas mixture:

CO: 50 to 500 ppm	HCN: 5 to 20 ppm
H ₂ S: 10 to 100 ppm	ClO ₂ : 0.1 to 1.0 ppm
PH ₃ : 1 to 5 ppm	O ₃ : 0.1 to 1.0 ppm
SO ₂ : 10 to 50 ppm	VOC: 100 ppm isobutylene
Cl ₂ : 3 to 25 ppm	LEL: 10 to 100% LEL or 0.5 to 5% by vol. methane
NH ₃ : 20 to 100 ppm	CO ₂ : 5000 ppm
NO ₂ : 5 to 50 ppm	O ₂ : clean air, 20.9 %
- To ensure accurate calibration, use a premium-grade calibration gas. Gases approved by the National Institute of Standards and Technology (NIST) improves the validity of the calibration.
- Do not use a gas cylinder beyond its expiration date.
- Calibrate a new sensor before use. Install the sensor, activate the detector, and allow the sensor to stabilize before starting calibration.
Used sensor: 60 seconds / New sensor: 5 minutes
- Calibrate the detector at least once every 180 days (every 90 days for HCN sensors) depending upon use and sensor exposure to poisons and contaminants.
- Calibrate the detector if the ambient gas varies during start-up.
- Calibrate the sensor before changing the alarm setpoints.
- Calibrate only in a safe area that is free of hazardous gas.
- To disable an alarm, set the alarm setpoint to **0** (zero).
- If the **Auto cal** option is enabled, the oxygen (O₂) sensor calibrates automatically every time the detector is activated. Activate the detector in a normal (20.9% oxygen) atmosphere.
- After activating the detector, allow it to stabilize for 1 minute before performing a calibration or bump test.
- If a certified calibration is required, contact your local Distributor or Honeywell Analytics.

NOTE

A generator must be used for O₃ and ClO₂ sensors.

NOTE

Honeywell Analytics recommends dedicating a regulator for use with Cl₂ gas to avoid lower calibration readings due to cross-interference with other gases.

Prior to performing the span calibration with Cl₂ detectors it is recommended that the user purge the regulator for 5 minutes (300 seconds) with Cl₂ gas to ensure the regulator is properly conditioned. This should be done any time a significant amount of time has passed since the regulator was last used (i.e. days).

Diagnostics Protection

The detector tests the ambient air (auto zero) and the test gas that is applied (auto span) to ensure it meets expected values. Auto zero sets the zero-gas level of the sensor. If ambient gas is present, the zero level will be incorrect.

If excessive target gas is present, the detector displays an error message and lists the affected sensor.

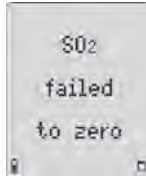

In auto span, if the target gas is not detected or does not meet expected values, a message displays that the detector is exiting calibration mode. The detector retains the previous set values.

Applying Gas to the Sensors

The calibration cap, single gas calibration cap, and hose are shipped with the detector. Refer to Figure 3 and Table 10 for installation.

NOTE

The calibration cap and single gas calibration cap can only be used during the calibration span process.

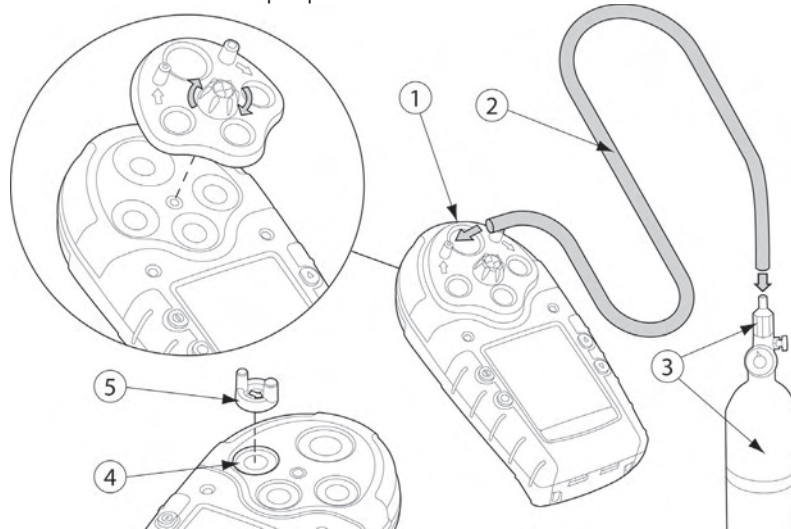

Figure 3. Applying Gas to the Sensors

Item	Description	Item	Description
1	Detector and calibration cap	4	Toxic 2 sensor position
2	Calibration hose	5	Single gas calibration cap
3	Regulator and gas cylinder		

Table 10. Applying Gas to the Sensors

Single Gas Calibration Cap

CAUTION

If an O₃ or ClO₂ sensor is located in the Toxic 2 position (refer to [Figure 3](#) and [Table 10](#)), a single gas calibration cap must be used to ensure accurate calibration.

To calibrate O₃ and ClO₂ sensors using the single gas calibration cap, refer to Figure 4, Table 11, and complete the following procedures:

1. Insert the cap into the Toxic 2 sensor position on the detector (refer to [Figure 3](#)). Press firmly until the release tabs click.
2. Connect the calibration hose to the gas cylinder and to the intake inlet on the cap.

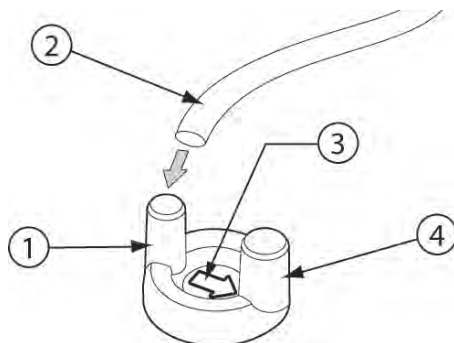

Figure 4. Single Gas Calibration Cap

Item	Description
1	Intake inlet
2	Calibration hose
3	Gas flow direction arrow
4	Output outlet

Table 11. Single Gas Calibration Cap

NOTE

The arrow on the cap indicates the direction of gas flow from intake to outtake.

Removing the Single Gas Calibration Cap

Using the thumb, push forward against both the inlet and the outlet simultaneously to remove the cap from the detector.

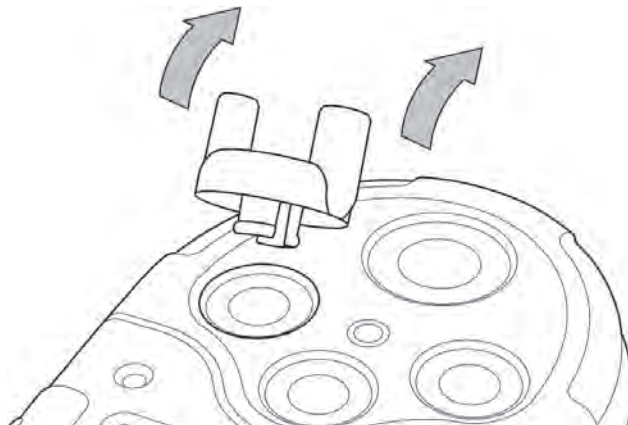

Figure 5. Removing the Single Gas Calibration Cap

Calibration Procedure

To calibrate the detector and set the alarm setpoints, perform the following procedures.

NOTE



To bypass a step during the calibration process (after auto zero), press 
Calibrate O₂ in clean air.

Start Calibration

NOTE

Verify that the calibration gas being used matches the span concentration value(s) that are set for the detector. Refer to [Span Gas Value](#).

Correction factors are not applied during calibration. Correction factors that were set prior to calibration are restored when the detector returns to normal operation.

1. To enter calibration, in a safe area that is free of hazardous gas, press and hold  and  simultaneously as the detector beeps, flashes, and vibrates to the corresponding countdown.

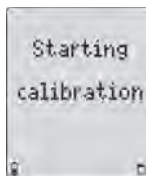

Auto Zero and Oxygen (O₂) Sensor Calibration

2. **AUTO-ZERO** flashes while the detector automatically zeroes the toxic and combustible sensors, and calibrates the O₂ sensor.

Depending upon the detector being calibrated, the auto zero screens display differently.

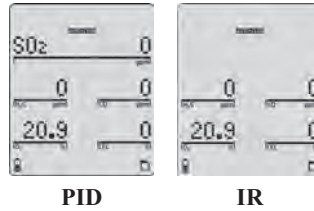

NOTE

Do not apply calibration gas during this process, otherwise the auto zero step will fail.

Zero CO₂ (IR only)

3. For IR models, there is a second auto zero function that is performed for the CO₂ sensor.

When auto zero for the other sensors is complete, the following screen displays.

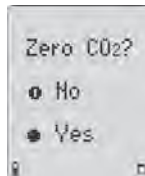

- 3a. Press **Yes** to zero the CO₂ sensor.

Or

Press **No** to bypass the CO₂ zero and proceed to [Auto Span](#). If the detector is passcode protected, refer to [Passcode Protect Activated](#).

If **Yes** is pressed, the following screen displays.

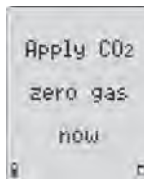

WARNING

Use only nitrogen (N₂) to zero the CO₂ sensor.

3b. Apply N₂ to zero the CO₂ sensor.

The following screen displays.



AUTO-ZERO flashes while the detector zeros the CO₂ sensor (approximately 30 seconds).

Passcode Protect Activated

(Optional)

4. When auto zero is complete and if the passcode protect option is enabled, the following screen displays.

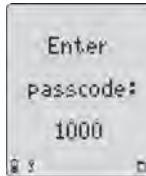

The passcode must be entered to proceed. If required, refer to [Passcode Protect](#) in User Options menu.

4a. Press ▲ or ▼ to scroll to the correct passcode and then press ○ within 5 seconds to confirm.

If entered correctly, the detector beeps twice and proceeds to the auto span.

Incorrect Passcode: If the passcode is incorrect or is not confirmed within 5 seconds by pressing ○, the following screens display.

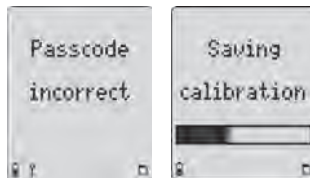

The detector saves the calibration and returns to normal operation.

Auto Span

5. When auto zero, CO₂ zero (if applicable), and the correct passcode is entered (if required), the following screens display.

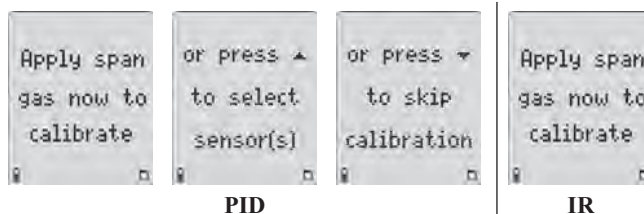

To select a sensor, refer to step # 5b [Select Sensor](#).

NOTE

Span sensors in the following order:

- Exotics (NH₃, ClO₂, O₃, Cl₂, and CO₂)
- Single gas
- Quad gas (H₂S, CO, LEL, and O₂)
- PID

Apply Span Gas Now

NOTE

A generator must be used for O₃ and ClO₂ sensors.

To ensure accurate calibration, a single gas calibration cap must be used to calibrate O₃ and ClO₂ sensors.

- **ClO₂**: Use a Tedlar bag as a buffer between the generator and the detector (using the single gas calibration cap) to regulate the flow rate to ensure accurate readings.
- Allow the Tedlar bag to fill for several minutes before initiating calibration.
- **O₃**: Calibrate only using the generator and the single gas calibration cap. Do not use a Tedlar bag.
- Set the generator to 0.5 ppm at a flow rate of 0.5 l/min. (liter per minute).

Depending upon the gas cylinder being used, one or all four sensors can be calibrated at one time.

- 5a. Attach the calibration cap (or single gas calibration cap for O₃ and ClO₂) and apply gas to the sensor(s). To attach caps, refer to [Figure 3](#).

Refer to the following flow rates:

- 1000 ml/min. for NH₃ and Cl₂
- 500 ml/min. for CO₂
- 250-500 ml/min. (all other sensors)

 flashes as the detector initially detects the calibration gas.

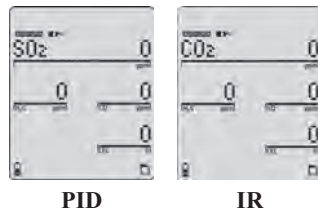

After 30 seconds the detector beeps and  stops flashing. **AUTO-SPAN** flashes while spanning the sensors until the detector has attained a sufficient level of the expected gas.

Refer to Table 12 for times required to span.

Gas Type	Time Required to Span
Most toxic gases and CO ₂	2 minutes
Exotic toxic gases	5 minutes
LEL (combustibles)	30 seconds
PID gases	2 minutes

Table 12. Time Required to Span

Insufficient Level: If a sensor does not attain a sufficient level of expected gas, it is cleared from the LCD and is not spanned.

While the detector is spanning the sensor(s), a countdown of time remaining displays in the lower left of the screen.

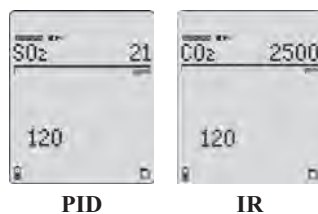

When the span is complete, the following screen displays.

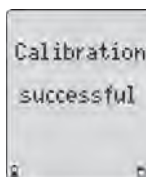

Proceed to [Successful Span](#) step #6. If problems occur during the span, refer to [Unsuccessful Span](#) for possible solutions.

Select Sensor

- 5b. Scroll \blacktriangledown to Sensor in user options and press \bigcirc . The following screen displays. The list of sensors will vary, depending upon the sensors that are installed.

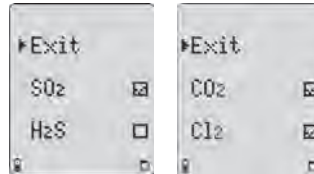

NOTE

Only sensors that are selected are accepted for the current span.

Ensure that the checkbox is enabled for the sensor that is to be spanned.

Press \bigcirc to exit. The **Apply span gas to calibrate** screen then displays. Refer back to step #5.

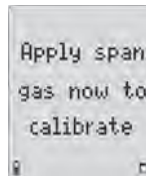

Skip Calibration

- 5c. If \bigcirc is pressed, proceed to step #7 [Setting the Calibration Due Date](#).

Successful Span

6. If the sensor(s) has spanned successfully, the audible alarm beeps three times and the following screens display.

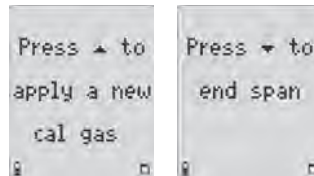

- 6a. If there are more sensors to span, remove the existing calibration gas cylinder and connect the next cylinder.

Press \blacktriangle and apply gas to span the other sensor(s).

Or

Press \blacktriangledown to end the span and proceed to step #7 [Setting the Calibration Due Date](#).

If all sensors have successfully spanned, the following screen displays prior to continuing with the calibration process.

Unsuccessful Span

If the sensor(s) did not span successfully, refer to the following sections for possible solutions:

- [Failed Span](#)
- [No Gas Detected](#)
- [Did Not Reach Target Span](#)
- [Large Span](#)

Failed Span

If a sensor fails the span, the following error message displays.

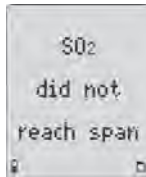

If the sensor is not recalibrated, the sensor displays as **FAIL** in normal operation the next time the detector is activated.



If all sensors fail the span, the following screen displays.

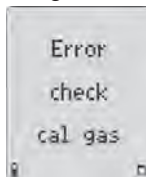

Press \odot to exit and then calibrate again in an atmosphere that is clear of the target gases. If the span fails a second time, reactivate the detector to test the sensors.

If all sensors fail the span, the due dates for calibration cannot be set.

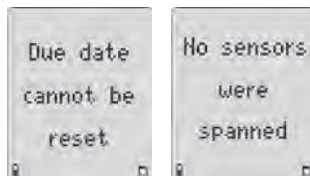

If the detector fails to span the sensors, confirm the following:

- Ensure gas is being applied to the sensor.
- Ensure the sensors detect at least one-half of the expected gas concentration in the first 30 seconds.
- Ensure the gas concentration does not drop below one-half of the expected gas concentration during the span.

If the detector still fails to span the sensor(s), repeat the calibration using a new gas cylinder.

If the span is still unsuccessful, replace the sensor(s). Refer to [Replacing a Sensor or Sensor Filter](#).

No Gas Detected

If the detector does not detect any gas within 30 seconds, the following screens display.

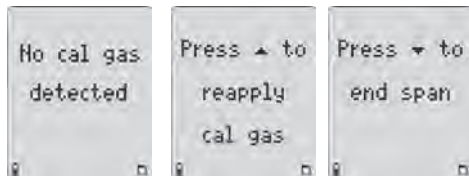

Press ▲ to reapply gas using another gas cylinder, or press ▼ to end the span and proceed to step #7.

Did Not Reach Target Span

If the span did not reach the target span as set in the user options menu ([Span Gas Value](#)) for the selected sensor, the detector displays the following screens.

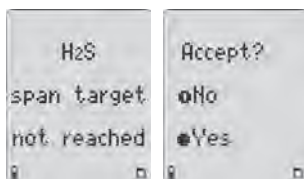

Not reaching the target span can be the result of

- a problem with the span gas,
- the gas cylinder being past the expiry date, or
- a problem with the sensor.

Accept Current Span: If the span gas, gas cylinder, and sensor appear to be correct, press ○ to accept the current span.

Reject Current Span: Press ⊙ to reject. Verify the span gas and the detector settings, and then calibrate the sensor again.

Large Span

If the span adjustment is unusually large (more than 15%), the following screens display.

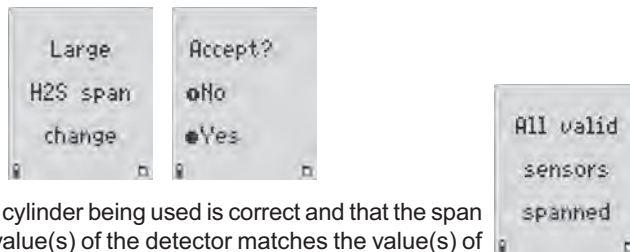

Ensure the gas cylinder being used is correct and that the span concentration value(s) of the detector matches the value(s) of the gas cylinder. Refer to [Span Gas Value](#) if required.

Adjustment Expected: If the calibration adjustment is expected, press ○ to accept the span.

Adjustment Not Expected: If the calibration adjustment is not expected or the span gas value does not match the gas cylinder, press ⊙ to reject the span and calibrate that sensor again.

Setting the Calibration Due Date

7. When the span is complete, the calibration due date can be set for each sensor that has spanned successfully. The following screen displays.

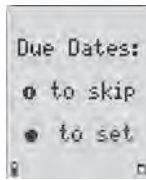

- 7a. Press ○ to set the calibration due dates, or press ⊙ to bypass and proceed to step #8.

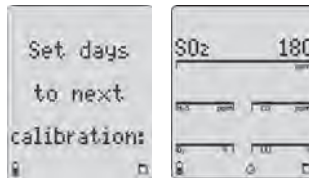

NOTE

Unless a new due date value is entered, the detector automatically resets to the previously entered number of days (eg. **180**) for each sensor that has spanned successfully.

The calibration due dates are set in the following order:

- Toxic 1
- Toxic 2
- LEL
- O₂

If the due date of an unsuccessfully spanned sensor is changed, the following screens display.

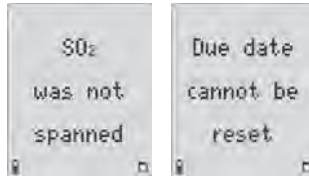

The detector then automatically proceeds to the next sensor.

- 7b. To change the calibration due date (**1-365** days), press ▼ or ▲ until the new value displays. Press ○ within 5 seconds to confirm.

Or

Press **Ⓢ** to bypass a sensor and proceed to the next sensor.

NOTE

If a value is changed but **○** is not pressed within 5 seconds to confirm, the following screen displays.

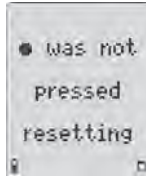

The previous value is automatically retained. The detector proceeds to the next sensor calibration due date.

7c. Repeat step #7 to set the calibration due dates for the remaining sensors.

7d. Press **○** to set the alarm setpoints and proceed to the following section Alarm Setpoints.

Or

Press **Ⓢ** to bypass setting the alarm setpoints and proceed to [Finish Calibration](#).

Alarm Setpoints

8. Factory alarm setpoints may vary by region. Refer to [Resetting Gas Alarm Setpoints](#) for an example. Alarms can be set to any value within the detection range of the selected sensor. Refer to [Specifications](#).

NOTE

To disable an alarm setpoint, set it to 0 (zero).

When setting alarm setpoints, if the new setpoint is not confirmed within 5 seconds by pressing **○**, the following screen displays.

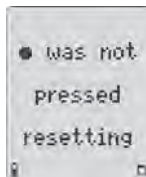

The previous setpoint is retained and the detector proceeds to the next setpoint.

The setpoints are set in the following order:

- TWA (if applicable)
- STEL (if applicable)
- low
- high

8a. To bypass a setpoint, press **○** to save the current value and proceed to the next setpoint.

Setting the TWA Alarm Setpoint

The current TWA alarm setpoint displays for the selected sensor (if applicable).



8b. Press \blacktriangledown or \blacktriangle to change the value for the TWA alarm setpoint. When the required value displays, press \bigcirc to confirm.

Setting the STEL Alarm Setpoint

The current STEL alarm setpoint displays for the selected sensor (if applicable).

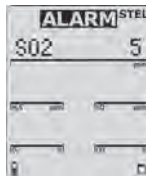

8c. Press \blacktriangledown or \blacktriangle to change the value for the STEL alarm setpoint. When the required value displays, press \bigcirc to confirm.

Setting the Low Alarm Setpoint

The current low alarm setpoint displays for the selected sensor.

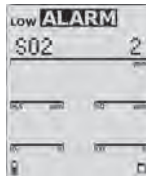

8d. Press \blacktriangledown or \blacktriangle to change the value for the low alarm setpoint. When the required value displays, press \bigcirc to confirm.

Setting the High Alarm Setpoint

The current high alarm setpoint displays for the selected sensor.

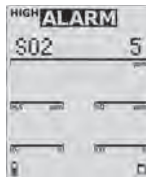

8e. Press \blacktriangledown or \blacktriangle to change the value for the high alarm setpoint. When the required value displays, press \bigcirc to confirm.

Setting the Remaining Alarm Setpoints

- Repeat steps #8 to 8e (if applicable) to set alarm setpoints for the remaining sensors. The audible alarm beeps four times when the alarm setpoint function is complete.

When the alarm setpoints have been set for all required sensors, the detector emits two quick beeps and then proceeds to the gas alarms setpoints screen.

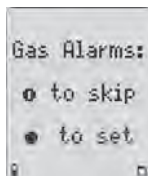

Finish Calibration

The detector displays the following screen to indicate that the calibration process is complete and then returns to normal operation.

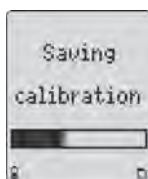

Verification

- After calibration is complete and the detector is in normal operation mode, verify the calibration by using a gas cylinder other than the one used for calibration.
- The gas concentration should not exceed the sensors detection range. Confirm that the LCD displays the expected concentration values.
- To ensure that the reading are accurate, apply the verification gas for the same amount of time as was applied to the sensor when it was calibrated.

Example: SO₂ span time 2 minutes therefore, apply verification gas for 2 minutes.

Attaching the Accessories

Installing the Pump Module

The HA motorized pump module is an optional accessory for the detector. The pump module is designed to be used with the sample probe to test for gases in confined spaces.

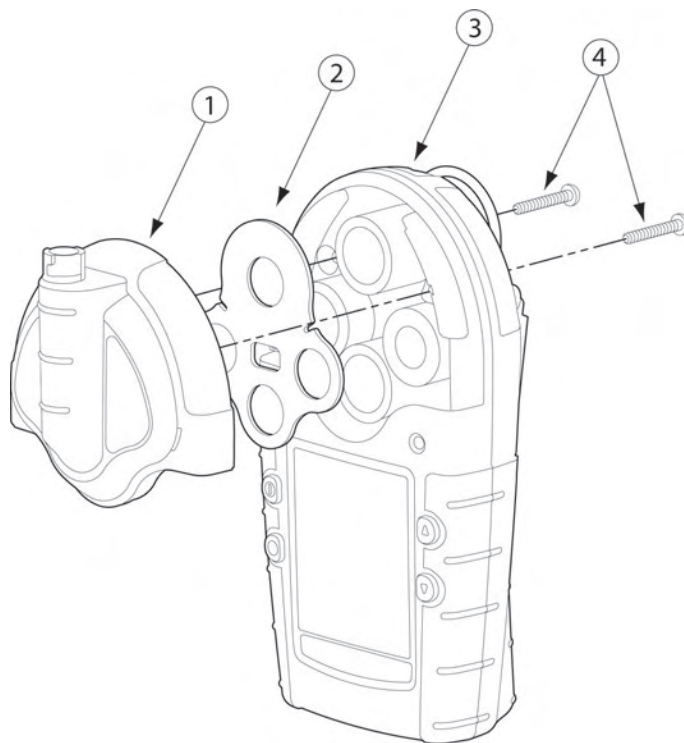

Figure 6. Installing the Pump Module

Item	Description
1	Motorized pump module
2	Sensor filter
3	Detector
4	Machine screws (2)

Table 13. Installing the Pump Module

NOTE

Do not exchange pump modules between detectors.

1. Deactivate the detector.
2. Remove the two machine screws and the sensor cover. Remove the sensor filter from the sensor cover and insert it into the pump module.
3. Attach the pump module to the detector and replace the two machine screws.

4. Activate the detector. The detector performs the start-up self-tests and the pump test. Refer to [Pump Test](#).
5. If the pump has been purchased separately (not included with the detector), the pump flow rate must be set prior to using the pump. Refer to [Pump](#) in [Tech Mode](#) options.

Attaching the Sample Probe

The sample probe is used to safely test for gas in confined spaces before entering.



Figure 7. Attaching the Sample Probe

Item	Description
1	Motorized pump module
2	Connector
3	Sample probe
4	Sample probe 10 in. tubing (custom lengths can be ordered)
5	Flexible connector hose

Table 14. Attaching the Sample Probe

WARNING

The sample probe must be used with the pump module only. Ensure that all connections are secure before sampling.

1. Deactivate the detector.
2. Make all of the required connections as illustrated in Figure 7.
3. Activate the detector.

4. Insert the sample probe tubing into the confined space.

Depending upon the length of the tubing and the type of gas in the confined space, allow a minimum of 3 seconds per ft. of hose to ensure the readings stabilize before entering the area.

Example: 50 ft. = 2.5 minutes

Replacing the Pump Auxiliary Filter

The X5 Pump Module Auxiliary Filter (“the filter”) filters out particulates that can decrease the life span of the pump.

CAUTION

The filter is designed to protect the pump. The filter must be connected when the pump is activated. Only remove the filter to perform calibrations, bump tests, and when using the sample probe.

Installing the Filter

1. Loop the filter cord around the ring on the alligator clip and pull the filter through the loop of the filter cord.

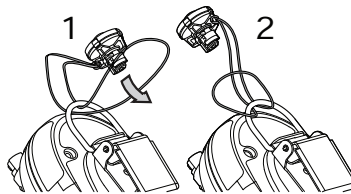

Figure 8. Attaching the Filter

NOTE

Connecting the filter cord to the alligator clip ensures the filter remains with the detector when not in use.

2. Pull the filter cord tight. Ensure the loop knot is secure.
3. Align the pump quick connector with the filter quick connector.
4. Insert the filter into the pump and turn clockwise. Ensure the connection is secure.

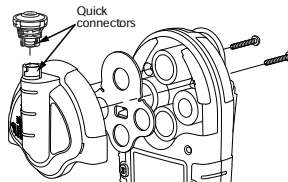

Figure 9. Connecting the Filter to the Pump

CAUTION

Change the filter as required. Environments with heavy airborne particulates require the filter to be changed frequently.

Datalogger

Detectors that are equipped with the datalogger option record information that can be compiled to create a report.

Datalog

Datalog information is recorded based on the sampling rate that is set in the **Logger** option. The detector can be set to record a datalog sample once every 1 to 127 seconds.

To set the sample rate, refer to [Logger Option](#) in the user options menu.

The following information is recorded in a datalog:

- Date and time
- Serial number of the detector
- Type of gas the detector monitors
- Gas reading(s) that display
- STEL and TWA readings
- Sensor status
- Detector status
- Passcode protect enabled/disabled
- STEL period setting
- Confidence beep enabled/disabled
- Automatic backlight enabled/disabled
- Stealth mode is enabled/disabled
- Latching alarm enabled/disabled
- Calibration past due user option enabled/disabled
- Language the detector is set to display

MMC Card Compatibility

The 128MB Delkin multi-media card (MMC) is compatible with the X5 detectors.



CAUTION

To ensure the Intrinsic Safety rating of the detector, use only the 128 MB Delkin MMC card.

To purchase additional MMC cards, refer to [Replacement Parts and Accessories](#).

Inserting the MMC Card

To insert the MMC card into the detector, refer to Table 15, Figure 7, and the following procedures.

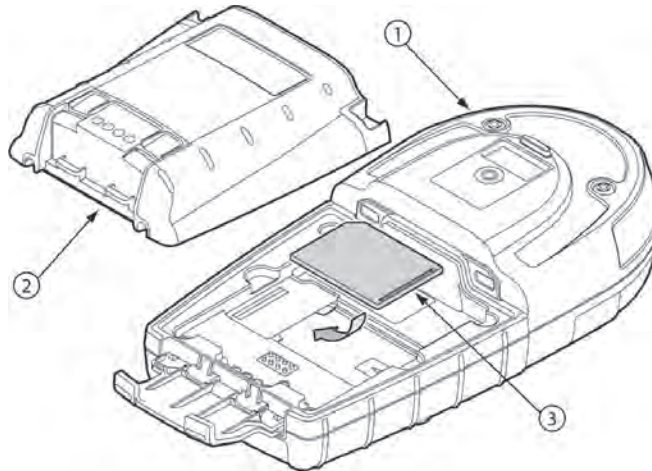

Figure 10. Installing and Removing the MMC Card

Item	Description
1	Back of detector
2	Battery pack
3	MMC card

Table 15. Removing the MMC Card

1. Deactivate the detector.
2. Release the latch and remove the battery pack. If required, refer to Figure 10.
3. Insert the MMC card pins face down.
4. Replace the battery pack and secure the latch.

MMC Card Troubleshooting

The MMC card is not required for operation in detectors equipped with datalogging. However, the following two screens display if the card is not inserted during start-up.

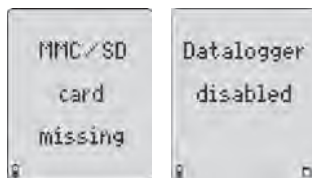

A new MMC card is automatically formatted when it is inserted in the detector. When the detector is activated, it begins the self-test and then displays the following screen.

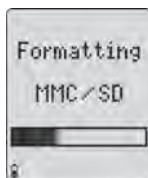

Restoring Datalog Files

If the MMC card has been accidentally reformatted or erased by the computer application, the following screens display when the card is inserted into the detector.

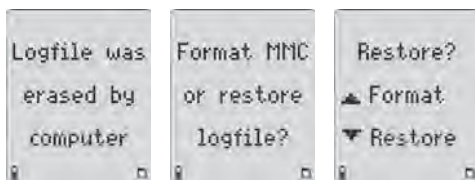

WARNING

Only erased data files can be restored using the detector. Computer applications sometimes write data over erased files and that erased data cannot be restored by the detector.

Always create back up files on the computer.

To restore the logfile, complete the following:

1. From the detector, press  to restore the logfile. The following screen displays.



If the detector successfully restores the logfile, the following screen displays and the start-up tests continue.

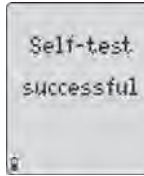

- Using the computer, verify that the logfile has been restored. When the normal operation screen displays, deactivate the detector.
- Remove the MMC card and insert it into the card reader.
- From the computer desktop, double-click **My Computer** to view the list of drives.
- Double-click the **Removable Disk** drive to access **LOGFILE0.csv**. Open the logfile and verify that the data has been restored.
If LOGFILE0.CSV does not display, ensure that the MMC card is inserted in the card reader correctly and that all connections are secure.
- After verifying that the logfile has been restored, re-insert the MMC card into the detector.

Reformatting the MMC Card

To reformat the MMC card, complete the following:

- Insert the MMC card into the card reader.
- From the computer desktop, double-click **My Computer** to view the list of drives.
- Double-click the **Removable Disk** drive to access **LOGFILE0.csv**.
- Select **LOGFILE0.csv** and delete.
- Insert the MMC card into the detector.
- Activate the detector. The start-up self-test begins and the following screens display.



- Press **▲** to format the MMC card. The following screen displays.

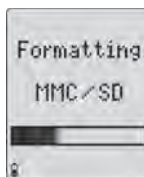

For any additional MMC card errors, refer to [Troubleshooting](#).

Viewing Datalog Files

The datalog files can be downloaded from the MMC/SD card using a card reader and opened with Microsoft® Excel. To view a datalog file, complete the following:

1. Deactivate the detector and remove the MMC/SD card (refer to Figure 10).
2. Insert the MMC/SD card into the card reader.
3. From the computer desktop, double-click My Computer to view the list of drives.
4. Double-click Removable Disk drive.
5. Double-click LOGFILE0.csv.

Refer to Table 16 for an example of the datalog spreadsheet. The Unit Config column (far right) in Table 16 contains letter codes. Refer to Table 17 and Table 18 for definitions of the codes.

Example of a Datalog

When datalog information is imported, it appears similar to the example below.

NOTE:

Not all columns are included in this example. Additional Toxic TWA and Toxic STEL display on a normal spreadsheet.



WARNING

Some compatible software packages have an internal file size limit of and may not load the entire file. Check the software limit.

Date dd-mm-yy	Day Mon=1	Time hh:mm:ss	Toxic1 ppm	Toxic2 ppm	Toxic3 ppm	LEL %CH4 %LEL	O2%	Toxic 1 TWA ppm	Toxic 1 STEL ppm	Status Codes	Serial Number	Unit Config
23-12-05	#4	9:54:25	5	10	35			--	--	33-----	S104-000001	
23-12-05	#4	9:54:30	10	15	50			--	--	44-----	S104-000001	
23-12-05	#4	9:54:35	5	10	35	10	19.5	--	--	1111----	S104-000001	
23-12-05	#4	9:54:40	10	15	200	20	23.5	--	--	2222----	S104-000001	
23-12-05	#4	9:54:45	0	0	0	24	20.9	--	--	-D-E--D	S104-000001	FCEKNL
23-12-05	#4	9:54:50	0	0	0	24	20.9	0	0	-----	S104-000001	FCEKNL
23-12-05	#4	9:54:55	0	0	0	24	20.9	0	0	--L----L	S104-000001	FCEKNL
23-12-05	#4	9:55:00	0	0	0	24	20.9	0	0	LLH---M	S104-000001	FCEKNL
23-12-05	#4	9:55:05	5	10	35			0	0	LLH---M	S104-000001	
23-12-05	#4	9:55:10	10	15	50			0	0	LLL---M	S104-000001	
23-12-05	#4	9:55:15	5	10	35	10	19.5	0	0	-L----L	S104-000001	
23-12-05	#4	9:55:20	10	15	200	20	23.5	0	0	-----	S104-000001	
23-12-05	#4	9:55:25	0	0	0	24	20.9	0	0	-----B-	S104-000001	FCEKNL
23-12-05	#4	9:55:30	0	0	0	24	20.9	0	0	-----B-	S104-000001	FCEKNL

Table 16. Datalog Spreadsheet Example



Status Codes			
Normal operation	G	Backlight is on	
Low alarm	v	STEL and high alarm (dual alarms)	1 Alarm setpoint 1 (low alarm)
High alarm	w	TWA and STEL alarm (dual alarms)	2 Alarm setpoint 2 (high alarm)
TWA alarm	x	TWA, STEL, and low (triple alarms)	3 Alarm setpoint 3 (TWA alarm)
TWA and low alarm (dual alarms)	y	TWA, STEL, and high (triple alarms)	4 Alarm setpoint 4 (STEL alarm)
TWA and high alarm (dual alarms)	O	Overload / sensor is over-ranged	D Calibration due date (days)
STEL alarm	C	Calibrating	E Elapsed / last calibration (days)
STEL and low alarm (dual alarms)	F	Failure - sensor failure	Z Auto zeroing
Fresh air delay	I	Time set	t testing
Zero CO2			
Pump Codes			
Plugged (blocked) - pump alarm	F	Failure / pump failure	
Battery Status Codes			
Batteries OK	B	Low battery alarm	C Confidence beep is active
Alarm Status Codes			
Low alarm	M	Multi-gas alarm	S Automatic shutdown
High alarm	C	Calibration	F Failure / self-test fail
TWA alarm	Q	Off/quit / manual shutdown	R RTCC / real-time clock failure

Note: TWA readings greater than 99 are recorded as OL.

Table 17. Datalog Status Codes

Gas Sensor Codes									
A	No sensor	B	H ₂ S	C	H ₂ S COSH	D	CO	E	CO COSH
F	SO ₂	G	PH ₃	H	NO ₂	I	HCN	J	Cl ₂
K	NH ₃	L	ClO ₂	M	O ₃	O	LEL	P	PID
Q	IR								
Correction Factor Codes for PID (if applicable)									
A	Acetaldehyde	B	Acetone	C	Ammonia	D	Benzene	E	Butadiene
F	Diesel	G	Ethanol	H	Ethylene	I	Gasoline	J	Hexane
K	Isobutyl	L	JP8	M	Kerosene	N	MEK	O	Naptha
P	Styrene	Q	Toluene	R	Turpentine	S	Vinyl_Cl	T	Xylene
U	Custom								
Correction Factor Codes for LEL									
A	Acetone	B	Benzene	C	Butane	D	Cyclohexane	E	Ethanol
F	Ethyl_Ace	G	Gasoline	H	Heptane	I	Hexane	J	Hydrogen
K	Isobutylene	L	Isopropanol	M	MEK	N	Methane	O	Methanol
P	Octane	Q	Pentane	R	Propane	S	Toluene	T	Turpentine

U	Custom	
LEL Unit Codes		
V	LEL in % by Vol CH ₄	L LEL in % LEL

Table 18. Datalog Gas and Correction Factor Sensor Codes

Item	Description
1	Detector
2	Latch
3	Battery pack
4	Battery tray
5	Captive screws (2)
6	Alkaline batteries (3)
7	Battery shell

Table 19. Replacing the Batteries

Maintenance

To maintain the detector in good operating condition, perform the following basic maintenance as required.

- Calibrate, bump test, and inspect the detector at regular intervals.
- Maintain an operations log of all maintenance, calibrations, bump tests, and alarm events.
- Clean the exterior with a soft damp cloth. Do not use solvents, soaps, or polishes.
- Do not immerse the detector in liquids.

Replacing/Charging the Batteries

WARNING

To avoid personal injury and/or property damage, adhere to the following:

- » Replace the batteries immediately when the detector emits a low battery alarm.
- » Use only batteries that are recommended by Honeywell Analytics.
- » Use only approved batteries, properly installed in the detector case. Refer to [Specifications](#) for approved batteries.
- » Charge batteries using only a recommended HA charger. Do not use any other charger. Failure to adhere to this precaution can lead to fire and/or explosion.
- » Both the rechargeable battery pack and the alkaline battery pack are user-changeable in hazardous locations, but the alkaline battery cells inside the pack can only be replaced in a safe area that is free of hazardous gas.

NOTE

To preserve battery life, deactivate the detector when not in use.

To charge the rechargeable battery pack, refer to the [X5 Battery Charger Instruction Guide](#).

To replace the alkaline batteries, refer to Table 19, Figure 19, and the following procedures.

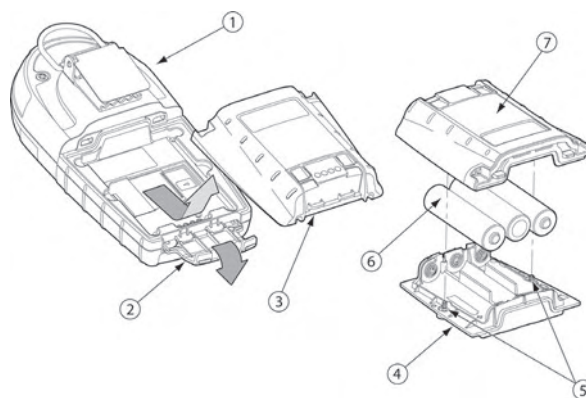

Figure 19. Replacing the Batteries

1. Open the latch on the bottom of the detector.
2. Remove the battery pack by lifting the bottom of the pack away from the detector.
3. Unscrew the two captive screws on the battery pack and open the pack.
4. Replace the three alkaline batteries and screw the battery pack back together.
5. Reinsert the battery pack and secure the latch.

Battery Pack

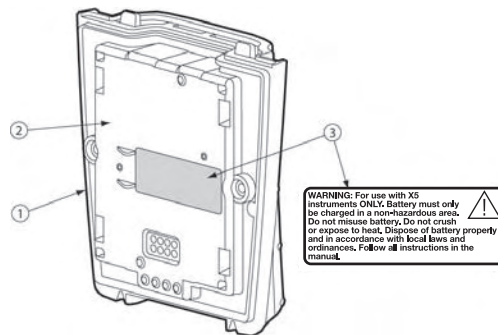

Figure 20. Battery Pack and Warning Label

Item	Description
1	Battery pack
2	Battery pack lid
3	Warning label on battery pack lid

Table 20. Battery Pack and Warning Label

Item	Description
1	Sensor cover
2	Sensor filter
3	Sensors
4	Detector
5	Machine screws (2)

Table 21. Replacing a Sensor or Sensor Filter

To prevent damage to the battery packs, refer to the label provided on the battery pack lid of the battery pack.

Replacing the Battery Pack Latch

To replace the battery latch, complete the following:

WARNING

Do not perform the following procedures in a hazardous location.

1. Open the latch and remove the battery pack from the detector.
2. Using the Phillips/hex screwdriver, loosen only; do not remove the screws.
3. Using a small flathead screwdriver, only slightly, separate the front of the detector from the back of the detector approximately 1/8 in. (3 mm).
4. Remove the damaged latch by pulling outward.

5. Insert the replacement latch.
6. Tighten the screws using only 3-4 in. lbs of torque. Do not overtighten the screws.
7. Reinsert the battery pack.
8. Close the latch and press until the release tabs click.

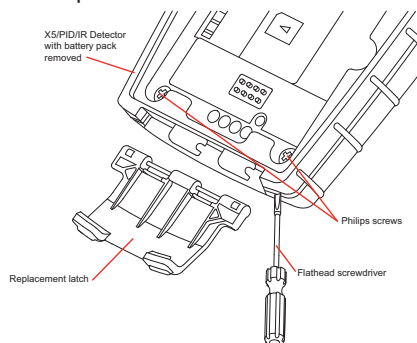

Figure 21. Replacing the Battery Latch

Replacing a Sensor or Sensor Filter

⚠ WARNING

To avoid personal injury, use only sensors specifically designed for the detector. Refer to [Replacement Parts and Accessories](#).

Each sensor has a high degree of resistance to common vapors and gases. To clear a sensor, move the detector to a clean environment and wait 10 to 30 minutes.

Do not expose a sensor to vapors of inorganic solvents such as paint fumes or organic solvents. Refer to [Troubleshooting](#) for reference to problems caused by a sensor that requires calibration or replacement.

To replace a sensor or sensor filter, refer to Figure 11, Table 21, and the following procedures.

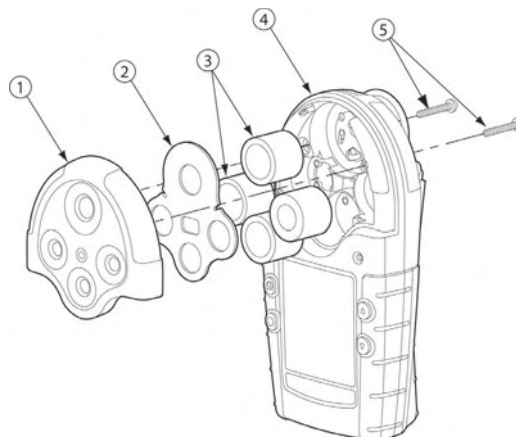

Figure 22. Replacing a Sensor or Sensor Filter

NOTE

Detectors that are configured for 1, 2, 3, or 4 gases may contain a dummy sensor in one of the four sensor locations.

1. If required, deactivate the detector.
2. Remove the two machine screws on the rear shell and then remove the sensor cover or optional pump module.
3. Remove the sensor filter and/or the sensor(s). Gently rocking the sensor back and forth may help free a tightly held sensor.
4. Insert the new filter and/or sensor. Ensure the sensor posts are aligned correctly.
5. Re-assemble the detector.
6. If the sensor is changed (eg. SO₂ to an H₂S), the detector must be reconfigured. Refer to the [Sensors](#) in the [Tech Mode](#) option.
7. Calibrate the detector after changing any sensor(s). Refer to [Calibration and Setting Alarm Setpoints](#).

Photoionization Detector (PID)**Clean or Replace the Lamp**

The PID lamp must be cleaned on a regular basis. Use only the cleaning kit that is supplied by Honeywell Analytics.

To clean the PID lamp, refer to the illustrations and procedures that are provided with the PID Lamp Cleaning Kit. To order the kit, refer to [Replacement Parts and Accessories](#).

NOTE

To ensure proper maintenance and continued accurate readings from the sensor, use only the PID Lamp Cleaning Kit that is supplied by Honeywell Analytics.

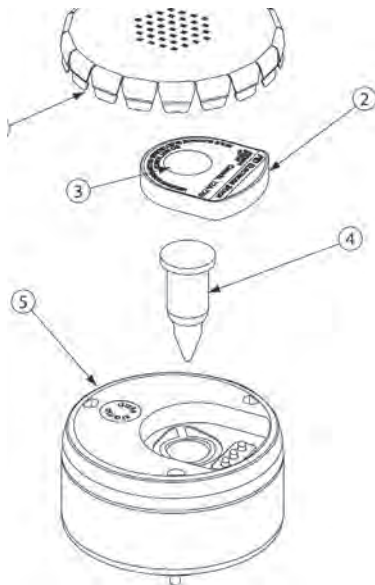

Item	Description
1	PID sensor
2	Diffusion barrier
3	Sensor cover
4	Electrode stack
5	Lamp

Table 22. Parts of the PID sensor

Figure 23. Parts of the PID

Replace the Lamp

Replace the lamp when it falls below the acceptable level. Possible indicators that the lamp requires replacement are as follows:

- The detector will not calibrate.
- The start-up self-test fails.
- The ppm levels are incorrect.

To replace the lamp, refer to the illustrations and procedures in the ***PID Lamp Cleaning Kit***.

If required, contact your local Distributor or Honeywell Analytics for more information.

Replace the Electrode Stack

Replace the electrode stack when it is contaminated. To replace the electrode stack, refer to [Table 22](#), [Figure 23](#), and the following procedures.

NOTE

Ensure your fingers do not make contact with the diffusion barrier or the electrodes on the underside of the stack.

1. Remove the sensor cover.
2. Remove the old electrode stack.
3. Insert the new electrode stack.
4. Replace the sensor cover.

Troubleshooting

If a problem occurs, refer to the solutions provided in Table 23. If the problem persists, contact your local Distributor or Honeywell Analytics.

Problem	Possible Cause	Solution
The detector does not activate.	No batteries	Refer to Replacing/Charging the Batteries .
	Depleted batteries	Refer to Replacing/Charging the Batteries .
	Damaged or defective detector	Call for Service.
The detector immediately enters alarm mode when activated.	Sensor needs to stabilize	Used sensor: wait 60 seconds New sensor: wait 5 minutes.
	Low battery alarm	Refer to Replacing/Charging the Batteries .
	Sensor alarm	Refer to Replacing a Sensor or Sensor Filter .
	Pump alarm	If the sampling hose is attached, determine if it is obstructed. If not, clean or replace the pump filter. If pump alarm persists, Call for Service.
The activation self-test fails.	General fault	Ensure that the sensors and battery pack are installed correctly and then activate the detector. If the fault persists, record the error message and Call for Service.
	The MMC card is not inserted.	Insert the MMC card. Refer to Inserting the MMC Card .
	The MMC card that is inserted in the detector has a storage size that is not supported by the detector.	Insert a 128 MB Delkin MMC card.

Table 23. Troubleshooting Tips

Problem	Possible Cause	Solution
	The detector has lost communication with the MMC card.	Retry communication
		Insert a new 128 MB Delkin MMC card.
		Reformat MMC card in windows and reinsert into the detector.
		Call for Service.
The detector displays a clock error message using last recorded time.	General fault	Reactivate the detector. If the same error message displays, reset the clock in user options menu. Reactivate the detector. If the error message still displays, Call for Service.
Detector does not display normal ambient gas reading after activation self-test.	Sensor not stabilized.	Used sensor: wait 60 seconds New sensor: wait 5 minutes
	Detector requires calibration.	Refer to Calibration and Setting Alarm Setpoints .
	Target gas is present.	Detector is operating properly. Use caution in suspect areas.
Detector does not respond to pushbuttons.	Batteries are depleted.	Refer to Replacing/Charging the Batteries .
	Detector is performing operations that do not require user input.	Pushbutton function restored automatically when the operation ends.
Detector does not accurately measure gas.	Detector requires calibration.	Calibrate the detector. Refer to Calibration and Setting Alarm Setpoints .
	Detector is colder/hotter than ambient gas.	Allow the detector to adjust to ambient temperature before using.
	Sensor filter is blocked.	Clean the sensor filter. Refer to Replacing a Sensor or Sensor Filter .
Detector does not enter alarm mode.	Alarm setpoint(s) are set incorrectly.	Reset alarm setpoints. Refer to Calibration and Setting Alarm Setpoints .
	Alarm setpoint(s) set to zero.	Reset alarm setpoints. Refer to Calibration and Setting Alarm Setpoints .
	Detector requires calibration.	Calibrate the detector. Refer to Calibration and Setting Alarm Setpoints .

Table 23. Troubleshooting Tips

Problem	Possible Cause	Solution
Detector intermittently enters alarm without any apparent reason.	Ambient gas levels are near alarm setpoint or the sensor is exposed to a puff of the target gas.	Detector is operating normally. Use caution in suspect areas. Check MAX gas exposure reading.
	Alarms set incorrectly.	Reset alarm setpoints. Calibration and Setting Alarm Setpoints.
	Missing or faulty sensor.	Refer to Replacing a Sensor or Sensor Filter.
Detector automatically deactivates.	Automatic shutdown activated because of weak batteries.	Refer to Replacing/Charging the Batteries.
Clock icon is flashing.	The clock has failed.	Call for Service.
	There is communication failure.	Call for Service.

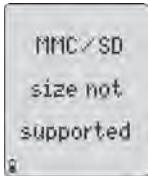
Table 23. Troubleshooting Tips

Replacement Parts and Accessories

 **WARNING**

To avoid personal injury and/or damage to the detector, use only the specified replacement parts.

To order parts or accessories listed in Table 24, contact your local Distributor or Honeywell Analytics.

Model No.	Description	Qty
1715-0108	Combustible sensor	1
1715-0103	O ₂ sensor	1
1715-0101	CO sensor	1
1715-0102	H ₂ S sensor	1
1715-0112	PH ₃ sensor	1
1715-0104	SO ₂ sensor	1
1715-0105	Cl ₂ sensor	1
1715-0109	NH ₃ sensor	1
1715-0107	NO ₂ sensor	1
1715-0106	HCN sensor	1
1715-0110	ClO ₂ sensor	1
1715-0113	O ₃ sensor	1
1715-0111	TwinTox CO/H ₂ S sensor	1
1715-0115	CO ₂ sensor (IR)	1
1715-0138	Lamp for PID sensor	1
1715-0166	Replacement PID Sensor with 2 Electrode stacks	1
1715-0126	Cleaning kit for PID sensor lamp	1
1715-0167	Sensor filters (quad) kit of 2	2
1715-0179	Quad calibration gas CH ₄ -2.5%, O ₂ -18.0%, H ₂ S-25 ppm, CO-100 ppm bal. N ₂ (58 L)	1
1715-0180	Quad calibration gas CH ₄ -2.5%, O ₂ -18.0%, H ₂ S-25 ppm, CO-100 ppm bal. N ₂ (34 L)	1
1715-0174	Regulator (0.5 L/min)	1
2302D0752	Calibration gas, H ₂ S 25 ppm (58 L)	1
08900-A-6664	Calibration gas, CO 200 ppm (103 L)	1
571361	Calibration gas, SO ₂ 25 ppm (58 L)	1
2302D0757	Calibration gas, Cl ₂ 5 ppm (58 L)	1
GFV234	Calibration gas, HCN 10 ppm (58 L)	1
GFV217	Calibration gas, NO ₂ 10 ppm (58 L)	1

Table 24. Replacement Parts and Accessories

Model No.	Description	Qty
2302D0756	Calibration gas NH ₃ , 50 ppm (34 L)	
1715-0181	Calibration gas, PH ₃ 1 ppm (58 L)	1
GFV306	Calibration gas Isobutylene 100 ppm (*103 L)	1
GFV278	Calibration gas, CH ₄ 50% LEL (34 L)	1
1715-0168	Quad calibration kit with regulator, quad gas cylinder (CG-Q34-4), hose and carrying case	1
1715-0169	Quad calibration kit with regulator, quad gas cylinder (CG-Q58-4), hose and carrying case	1
1715-0170	128 MB Delkin Multi-media (MMC) card	1
1715-0127	Lithium-Polymer Ion Rechargeable battery pack	1
1715-0128	Alkaline battery pack	1
1715-0129	Alkaline battery pack with European screws	1
1715-0123	X5 battery charger	1
1715-0136	Vehicle X5 battery charger	1
1715-0124	Motorized Pump Module Kit	1
1715-0125	Sample pump with 1 ft./0.3 m probe tubing	1
1715-0161	Calibration cap and hose	1
1715-0172	Alligator clip (stainless steel)	1
1715-0173	Chest harness	1

Table 24. Replacement Parts and Accessories

Specifications

Instrument Dimensions	5.7 x 2.9 x 1.5 in. / 14.5 x 7.4 x 3.8 cm
Weight	13.1 oz. / 370 g
Operating and Storage Conditions	
Temperature	VOC: -14° to +104°F / -10° to +40°C Other gases: -4° to +122°F / -20° to +50°C
Humidity	O₂: 0% to 99% relative humidity (non-condensing) VOC and CO₂ IR: 0% to 95% relative humidity (non-condensing) Combustibles: 5% to 95% relative humidity (non-condensing) Cl₂: 10% to 95% relative humidity (non-condensing) HCN, ClO₂: 15% to 95% relative humidity (non-condensing) Other gases: 15% to 90% relative humidity (non-condensing)
Pressure	95 to 110 kPa
Alarm Setpoints	May vary by region and are user-settable.
Detection Range	O ₂ : 0 – 30.0% vol. (0.1% vol. increments) CO: 0 – 999 ppm (1 ppm increments) CO (TwinTox sensor): 0 – 500 ppm (1 ppm increments) H ₂ S: 0 – 500 ppm (1 ppm increments) H ₂ S (TwinTox sensor): 0 – 500 ppm (1 ppm increments) Combustibles: 0 – 100% LEL (1% LEL increments) or 0 – 5.0% v/v methane PH ₃ : 0 – 5.0 ppm (0.1 ppm increments) SO ₂ : 0 – 150 ppm (1 ppm increments) Cl ₂ : 0 – 50.0 ppm (0.1 ppm increments) NH ₃ : 0 – 100 ppm (1 ppm increments) NO ₂ : 0 – 99.9 ppm (0.1 ppm increments) HCN: 0 – 30.0 ppm (0.1 ppm increments) ClO ₂ : 0 – 1.00 ppm (0.01 ppm increments) O ₃ : 0 – 1.00 ppm (0.01 ppm increments) VOC: 0 – 1000 ppm (1.0 ppm increments) CO ₂ IR: 0-50,000 ppm (150 ppm increments) or 0-5.0% v/v CO ₂
Sensor Type	H ₂ S/CO: Twin plug-in electrochemical cell Combustibles: Plug-in catalytic bead VOC: Photoionization detector (PID) CO ₂ : IR detector Other gases: Single plug-in electrochemical cell
O₂ Measuring Principle	Capillary controlled concentration sensor
Alarm Conditions	TWA alarm, STEL alarm, low alarm, high alarm, multi-gas alarm, over range alarm, sensor alarm, pump alarm, MMC card fail alarm, low battery alarm, confidence beep, automatic shutdown alarm
Audible Alarm	95 dB at 1 ft. (0.3 m) variable pulsed dual beepers

Visual Alarm	Dual red light-emitting diodes (LED)
Display	Alphanumeric liquid crystal display (LCD)
Backlight	Automatically activates whenever there is insufficient light to view the LCD (if enabled) and during alarm conditions.
Self-test	Initiated upon activation
Calibration	Automatic zero and automatic span
Oxygen Sensor	Automatic span upon activation (selectable)
User Field Options	Confidence beep, latching low and high alarms, pass code protection, enable/disable safe display mode, enable/disable, combustible sensor measurement, sensor disable, TWA and STEL, language selection, enable/disable automatic oxygen calibration, set span concentration values, set STEL calculation period, set TWA method, gas measurement resolution, enable/disable automatic backlight, adjust clock calendar, and set logging rate (datalogger models only), and CO ₂ sensor measurement.
Datalogger X5 Units	Approved for X5 models: Delkin 128 MB MMC Card
Year of Manufacture	The detectors year of manufacture is determined from the serial number. The second and third number after the first letter determines the year of manufacture E.g., H308-Y000001 = 2008 year of manufacture
Battery Operating Time	<p>Toxic, O₂, and LEL sensors: Three alkaline cells or one lithium battery pack at 20°C provides 20 hours operating runtime One lithium battery pack at 20°C provides 11 hours operating runtime with pump</p> <p>Toxic, O₂, LEL, and PID sensors: Three alkaline cells or one lithium battery pack at 20°C provides 15 hours operating runtime One lithium battery pack at 20°C provides 11 hours operating runtime with pump</p> <p>Toxic, O₂, LEL, and CO₂ IR sensors: Three alkaline cells or one lithium battery pack at 20°C provides 13 hours operating runtime One lithium battery pack at 20°C provides 9 hours operating runtime with pump</p>

	Approved Batteries For Product (Standards IEC 60079-11, EN50020, UL913, CSA C22.2 No. 157)		
Approved Batteries	Alkaline		Temperature Code
	Duracell MN1500	-20°C ≤ Ta ≤ +50°C	T3C (139.8°C)
		-20°C ≤ Ta ≤ +40°C	T4 (129.8°C)
	Energizer E91	-20°C ≤ Ta ≤ +50°C	T3B (163°C)
		-20°C ≤ Ta ≤ +40°C	T3C (153°C)
	Xellex LR6	-20°C ≤ Ta ≤ +50°C	T4 (107°C)
Lithium-Ion-Polymer Rechargeable		Temperature Code	
1715-0127	-20°C ≤ Ta ≤ 50°C	T4 (135°C)	
Battery Charger	X5 battery charger First-time charge: 4 hours per battery pack Normal charge: 3-4 hours per battery pack		
Warranty	2 years including sensors (1 year for NH ₃ sensor and PID lamp)		
Approvals:	<p>X5 and X5 PID cCSAus: approved by CSA to both U.S. and Canadian Standards ATEX: Pending Approved: Class I, Division 1, Group A, B, C, and D; Standards: CAN/CSA C22.2 No. 157 and C22.2 152 ANSI/UL – 913 and ANSI/ISA – S12.13 Part 1 IECEx: Pending</p> <p>X5 IR (Approved for Zone 1) cCSAus: approved by CSA to both U.S. and Canadian Standards ATEX: Pending Approved: Class I, Division 1, Group A, B, C, and D; Standards: CAN/CSA C22.2 No. 157 and C22.2 152 ANSI/UL – 913 and ANSI/ISA – S12.13 Part 1 IECEx: Pending</p>		

This equipment has been tested and found to comply with the limits for a Class B digital device, pursuant to Part 15 of the FCC Rules and ICES-003 Canadian EMI requirements. These limits are designed to provide reasonable protection against harmful interference in a residential installation. This equipment generates, uses and can radiate radio frequency energy and, if not installed and used in accordance with the instructions, may cause harmful interference to radio communications. However, there is no guarantee that interference will not occur in a particular installation. If this equipment does cause harmful interference to radio or television reception, which can be determined by turning the equipment off and on, the user is encouraged to try to correct the interference by one of more of the following measures:

- Reorient or relocate the receiving antenna.
- Increase the separation between the equipment and receiver.
- Connect the equipment into an outlet on a circuit different from that to which the receiver is connected.
- Consult the dealer or an experienced radio/TV technician for help.

General Specifications for Datalogger Units

Media Type	Delkin Multi-Media (MMC) card
Size	128 MB
Storage	500,000 lines of data available; 4.4 months at 5 second intervals (based on a normal work week)
Memory Type	Wrap-around memory ensures most recent data is always saved
Sample Rate	One reading every 5 seconds (standard)
Data Recorded	All sensor readings, all alarm conditions, calibrations, event flags, battery status, pump status, sensor status, confidence beep activation, and detector status that includes the date, time and unit serial number for each reading
MMC Card Test	Automatically during activation

X5 with User Downloadable Datalogger

Operation	Requires no user intervention (automatic)
Indicators	Icon advises datalogger is operating normally, MMC card missing/malfunction advise
Compatible with	Desktop PC computer or laptop
Operating System	Windows XP or higher
Download Via	MMC card reader
Card Alarm	Card fail or missing.

Appendix A

PID Correction Factor (CF) Library

Gas #	Gas Type	LCD Gas Type Abbreviation	Correction Factor Value (CF values subject to change)
1	No PID correction factor	N/A	N/A
2	Acetaldehyde	Acetdhd	4.6
3	Acetone	Acetone	1.2
4	Ammonia	Ammonia	10.6
5	Benzene	Benzene	0.5
6	Butadiene	Butadien	0.9
7	Diesel	Diesel	0.9
8	Ethanol	Ethanol	13.3
9	Ethylene	Ethylene	9.1
10	Gasoline	Gasoline	0.7
11	Hexane	Hexane	4.6
12	Isobtyln	Isobtyln	1.0
13	JP8	JP-8	0.5
14	Kerosene	Kerosene	1.1
15	MEK	MEK	0.9
16	Naptha	Naptha	1.0
17	Styrene	Styrene	0.5
18	Toluene	Toluene	0.5
19	Turpentine	Turpentine	0.5
20	Vinyl Chloride	Vinyl Chloride	2.2
21	Xylene	Xylene	0.5
22	Custom	Custom	0.1 to 15.0

Table 25. PID Corrections Factor (CF) Library for Common Gases

Other PID Gases

Gas Name	Formula	Ionization Potential	Detectable by 10.6 eV Lamp	10.6 eV Lamp CF
Acetaldehyde	C ₂ H ₄ O	10.23	Yes	4.7
Acetic acid	C ₂ H ₄ O ₂	10.66	Yes	20 - 24
Acetic Anhydride	C ₄ H ₆ O ₃	10.14	Yes	+
Acetone	C ₃ H ₆ O	9.69	Yes	1.1
Acrolein	C ₃ H ₄ O	10.22	Yes	+
Acrylic Acid	C ₃ H ₄ O ₂	10.6	Yes	+
Allyl alcohol	C ₃ H ₆ O	9.63	Yes	2.3 - 2.5

Table 26. Other PID Gases

Gas Name	Formula	Ionization Potential	Detectable by 10.6 eV Lamp	10.6 eV Lamp CF
Allyl chloride	C ₃ H ₅ Cl	10.05	Yes	+
Ammonia	H ₃ N	10.18	Yes	11.2
Ammonium chloride	NH ₄ Cl	10.1	Yes	+
Amyl acetate, n-	C ₇ H ₁₄ O ₂	9.9	Yes	2.2 – 2.4
Amyl alcohol	C ₅ H ₁₂ O	10	Yes	4.8 – 5.2
Aniline	C ₆ H ₇ N	7.7	Yes	0.5
Anisole	C ₇ H ₈ O	8.21	Yes	0.7 – 0.9
Arsine	AsH ₃	9.89	Yes	1.8 – 2.0
Asphalt, petroleum fumes		9	Yes	+
Benzaldehyde	C ₇ H ₆ O	9.49	Yes	0.7
Benzenamene	C ₆ H ₇ N	7.7	Yes	0.5
Benzene	C ₆ H ₆	9.24	Yes	0.5
Benzenethiol	C ₆ H ₅ SH	8.32	Yes	+
Benzonitrile	C ₇ H ₅ N	9.62	Yes	+
Benzyl alcohol	C ₇ H ₈ O	8.26	Yes	1.0 – 1.2
Benzyl chloride	C ₇ H ₇ Cl	9.14	Yes	0.5 – 0.7
Benzyl formate	C ₈ H ₈ O ₂	9.32	Yes	0.6 – 0.8
Biphenyl	C ₁₂ H ₁₀	8.23	Yes	+
Bis(2,3-epoxypropyl) ether	C ₆ H ₁₀ O ₃	9	Yes	+
Bitumen, petroleum fumes		9	Yes	+
Bromine	Br ₂	10.55	Yes	+
Bromobenzene	C ₆ H ₅ Br	8.98	Yes	+
Bromochloromethane	CH ₂ ClBr	10.77	Yes	+
Bromoethane	C ₂ H ₅ Br	10.29	Yes	+
Bromoethyl methyl ether, 2-	C ₃ H ₇ OBr	10	Yes	0.8 – 0.9
Bromoform	CHBr ₃	10.48	Yes	+
Bromopropane, 1-	C ₃ H ₇ Br	10.18	Yes	+
Butadiene	C ₄ H ₆	9.07	Yes	0.9
Butadiene diepoxide, 1,3-	C ₄ H ₆ O ₂	10	Yes	3.3 – 3.7
Butan-2-one	C ₄ H ₈ O	9.51	Yes	0.9
Butane, n-	C ₄ H ₁₀	10.63	Yes	+
Butanol, 1-	C ₄ H ₁₀ O	10.04	Yes	+
Buten-3-ol, 1-	C ₄ H ₈ O		Yes	4.5 – 4.9
Butene, 1-	C ₄ H ₈	9.58	Yes	0.8 – 1.0
Butoxyethanol, 2-	C ₆ H ₁₄ O ₂	10	Yes	1.1 – 1.3
2-butoxyethyl acetate	C ₈ H ₁₆ O ₃		Yes	+

Table 26. Other PID Gases

Gas Name	Formula	Ionization Potential	Detectable by 10.6 eV Lamp	10.6 eV Lamp CF
Butyl acetate, n-	C ₆ H ₁₂ O ₂	10	Yes	2.4 – 2.8
Butyl acrylate, n-	C ₇ H ₁₂ O ₂	9	Yes	1.5 – 1.7
Butyl lactate	C ₇ H ₁₄ O ₃	9	Yes	+
Butyl mercaptan	C ₄ H ₁₀ S	9.15	Yes	0.5 – 0.6
t-Butyl methyl ether (MTBE)	C ₅ H ₁₂ O	9.24	Yes	0.8
Butylamine, 2-	C ₄ H ₁₁ N		Yes	+
Butylamine, n-	C ₄ H ₁₁ N	8.71	Yes	1.0 – 1.2
Camphene	C ₁₀ H ₁₆		Yes	+
Carbon disulfide	CS ₂	10.08	Yes	+
Carbon tetrabromide	CBr ₄	10.31	Yes	+
Chlorine dioxide	ClO ₂	10.36	Yes	+
Chloro-1,3-butadiene, 2-	C ₄ H ₅ Cl	8.79	Yes	2.5 – 3.5
Chlorobenzene	C ₆ H ₅ Cl	9.07	Yes	0.4
Chloroethyl methyl ether, 2-	C ₃ H ₇ ClO	9	Yes	2.8 – 3.2
Chlorotoluene, o-	C ₇ H ₇ Cl	8.83	Yes	0.5 – 0.6
Chlorotoluene, p-	C ₇ H ₇ Cl	8.69	Yes	0.5 – 0.6
Chlorotrifluoroethylene	C ₂ ClF ₃	9.81	Yes	+
Cresol, m-	C ₇ H ₈ O	8.97	Yes	+
Cresol, o-	C ₇ H ₈ O	8.97	Yes	+
Cresol, p-	C ₇ H ₈ O	8.97	Yes	+
Crotonaldehyde	C ₄ H ₆ O	9.73	Yes	1.0 – 1.2
Cumene	C ₉ H ₁₂	8.75	Yes	0.5 – 0.6
Cyanamide	CH ₂ N ₂	10.65	Yes	+
Cyclohexane	C ₆ H ₁₂	9.86	Yes	1.4
Cyclohexanol	C ₆ H ₁₂ O	10	Yes	2.9
Cyclohexanone	C ₆ H ₁₀ O	9.4	Yes	0.9
Cyclohexene	C ₆ H ₁₀	8.95	Yes	0.8 – 0.9
Cyclohexylamine	C ₆ H ₁₃ N	8.37	Yes	1.1 – 1.3
Cyclopentane	C ₅ H ₁₀	10.52	Yes	+
Decane, n-	C ₁₀ H ₂₂	9.65	Yes	1.3
Diacetone alcohol	C ₆ H ₁₂ O ₂		Yes	0.7 – 0.8
Dibromochloromethane	CHBr ₂ Cl	10.59	Yes	+
Dibromoethane 1,2-	C ₂ H ₄ Br ₂	9.45	Yes	1.6 – 1.8
Dichloro-1-propene, 2,3-	C ₃ H ₄ Cl ₂	10	Yes	0.9 – 1.0
Dichloroacetylene	C ₂ Cl ₂	9.9	Yes	+
Dichlorobenzene o-	C ₆ H ₄ Cl ₂	9.06	Yes	0.4 – 0.5

Table 26. Other PID Gases

Gas Name	Formula	Ionization Potential	Detectable by 10.6 eV Lamp	10.6 eV Lamp CF
Dichloroethene, 1,1-	C ₂ H ₂ Cl ₂	10	Yes	0.9 – 1.0
Dichloroethene, cis-1,2-	C ₂ H ₂ Cl ₂	9.66	Yes	0.8 – 0.9
Dichloroethene, trans-1,2-	C ₂ H ₂ Cl ₂	9.65	Yes	0.4 – 0.5
Dichloroethylene, 1,1-	Cl ₂ C ₂ H ₂	9.81	Yes	0.9
Dichloroethylene 1,2-	C ₂ H ₂ Cl ₂	9.65	Yes	+
Dicyclopentadiene	C ₁₀ H ₁₂	9	Yes	0.4 – 0.5
Diesel Fuel		9	Yes	1.0
Diethyl ether	C ₄ H ₁₀ O	9.53	Yes	1.1
Diethyl sulphide	C ₄ H ₁₀ S	8.43	Yes	0.5 – 0.6
Diethylamine	C ₄ H ₁₁ N	8.01	Yes	0.9 – 1.1
Diethylaminoethanol, 2-	C ₆ H ₁₅ ON		Yes	+
Diethylaminopropylamine, 3-	C ₇ H ₁₈ N ₂	9	Yes	1.2 – 1.4
Dihydrogen selenide	H ₂ Se	9.88	Yes	+
Diisobutylene	C ₈ H ₁₆		Yes	+
Diisopropyl ether	C ₆ H ₁₄ O	9.2	Yes	0.8 – 0.9
Diisopropylamine	C ₆ H ₁₅ N	7.73	Yes	0.7 – 0.8
Diketene	C ₄ H ₄ O ₂	9.6	Yes	1.9 – 2.1
Dimethoxymethane	C ₃ H ₈ O ₂	9.7	Yes	+
Dimethyl benzene	C ₈ H ₁₀	8.56	Yes	0.5
Dimethyl disulphide	C ₂ H ₆ S ₂	7.4	Yes	0.2 – 0.3
Dimethyl ether	C ₂ H ₆ O	10.03	Yes	+
Dimethyl formamide, N,N- (DMF)	C ₃ H ₇ NO	9.13	Yes	0.8
Dimethyl phthalate	C ₁₀ H ₁₀ O ₄	9.64	Yes	+
Dimethyl sulphide	C ₂ H ₆ S	8.69	Yes	0.4 – 0.5
Dimethylacetamide N,N-	C ₄ H ₉ NO	8.81	Yes	0.8 – 0.9
Dimethylamine	C ₂ H ₇ N	8.24	Yes	1.4 – 1.6
Dimethylaminoethanol	C ₄ H ₁₁ NO	9	Yes	+
Dimethylaniline, NN-	C ₈ H ₁₁ N	9	Yes	+
Dimethylbutyl acetate	C ₈ H ₁₆ O ₂	7.74	Yes	+
Dimethylethylamine, NN-	C ₄ H ₁₁ N	9	Yes	0.9 – 1.1
Dimethylformamide	C ₃ H ₇ NO	9.13	Yes	0.8 – 0.9
Dimethylheptan-4-one, 2,6-	C ₉ H ₁₈ O	9.04	Yes	+
Dimethylhydrazine, 1,1-	C ₂ H ₈ N ₂	8.05	Yes	0.8 – 0.9
Dinitrobenzene, m-	C ₆ H ₄ N ₂ O ₄	10.43	Yes	+
Dinitrobenzene, p-	C ₆ H ₄ N ₂ O ₄	10.5	Yes	+
Dinonyl phthalate	C ₂₆ H ₄₂ O ₄	9.19	Yes	+

Table 26. Other PID Gases

Gas Name	Formula	Ionization Potential	Detectable by 10.6 eV Lamp	10.6 eV Lamp CF
Dioxane 1,2-	C ₄ H ₈ O ₂		Yes	+
Dioxane 1,4-	C ₄ H ₈ O ₂	9.13	Yes	1.2
Diphenyl ether	C ₁₂ H ₁₀ O	8.09	Yes	+
Diphenylamine	C ₁₂ H ₁₁ N	7.4	Yes	+
Divinylbenzene	C ₁₀ H ₁₀	9	Yes	+
Epichlorohydrin	C ₃ H ₅ ClO	10.2	Yes	+
Epoxypropyl isopropyl ether, 2,3-	C ₆ H ₁₂ O ₂		Yes	+
Ethanal	C ₂ H ₄ O	10.23	Yes	4.7
Ethanol	C ₂ H ₆ O	10.43	Yes	13.3
Ethanolamine	C ₂ H ₇ NO	10.47	Yes	+
Ethoxyethanol, 2-	C ₄ H ₁₀ O ₂	9.6	Yes	1.2 – 1.4
Ethyl (S)-(-)-lactate	C ₅ H ₁₀ O ₃	10	Yes	3.0 – 3.4
Ethyl acetate	C ₄ H ₈ O ₂	10.01	Yes	5.1
Ethyl alcohol	C ₂ H ₆ O	10.43	Yes	13.3
Ethyl acrylate	C ₅ H ₈ O ₂	10.3	Yes	+
Ethyl amine	C ₂ H ₇ N	8.86	Yes	0.8 – 0.9
Ethyl benzene	C ₈ H ₁₀	8.76	Yes	0.5 – 0.6
Ethyl butyrate	C ₆ H ₁₂ O ₂		Yes	+
Ethyl chloroformate	C ₃ H ₅ O ₂ Cl	10.64	Yes	+
Ethyl formate	C ₃ H ₆ O ₂	10.61	Yes	+
Ethyl hexyl acrylate, 2-	C ₁₁ H ₂₀ O ₂	9	Yes	1.0 – 1.2
Ethyl mercaptan	C ₂ H ₆ S	9.29	Yes	0.5 – 0.6
Ethylene	C ₂ H ₄	10.51	Yes	10.1
Ethylene glycol	C ₂ H ₆ O ₂	10.16	Yes	17.0
Ethylene oxide	C ₂ H ₄ O	10.56	Yes	12.5
Ferrocene	C ₁₀ H ₁₀ Fe	6.88	Yes	+
Formamide	CH ₃ ON	10.2	Yes	+
Furfural	C ₅ H ₄ O ₂	9.21	Yes	0.9 – 1.0
Furfuryl alcohol	C ₅ H ₆ O ₂	9.5	Yes	0.8 – 0.9
Gasoline vapors			Yes	0.7
Gasoline vapors 92 octane			Yes	0.7
Glutaraldehyde	C ₅ H ₈ O ₂	9	Yes	0.8 – 0.9
Heptan-2-one	C ₇ H ₁₄ O	9.33	Yes	0.9
Heptan-3-one	C ₇ H ₁₄ O	9.02	Yes	+
Heptane n-	C ₇ H ₁₆	9.92	Yes	3.0
Hexamethyldisilazane, 1,1,1,3,3,3-	C ₆ H ₁₉ NSi ₂	8.6	Yes	0.2 – 0.3

Table 26. Other PID Gases

Gas Name	Formula	Ionization Potential	Detectable by 10.6 eV Lamp	10.6 eV Lamp CF
Hexan-1-ol	C ₆ H ₁₄ O	9.89	Yes	2.3
Hexan-2-one	C ₆ H ₁₂ O	9.34	Yes	0.9
Hexane n-	C ₆ H ₁₄	10.13	Yes	4.3
Hexene, 1-	C ₆ H ₁₂	9.44	Yes	0.8 – 0.9
Hydrazine	H ₄ N ₂	8.93	Yes	2.4 – 2.8
Hydrogen peroxide	H ₂ O ₂	10.54	Yes	+
Hydrogen sulfide	H ₂ S	10.46	Yes	3.3
Hydroquinone	C ₆ H ₆ O ₂	7.94	Yes	+
Hydroxypropyl acrylate 2-	C ₆ H ₁₀ O ₃	9	Yes	+
Iminodi(ethylamine) 2,2-	C ₄ H ₁₃ N ₃	9	Yes	+
Iminodiethanol 2,2-	C ₄ H ₁₁ NO ₂	9	Yes	+
Indene	C ₉ H ₈	8.81	Yes	+
Iodine	I ₂	9.31	Yes	0.1 – 0.2
iodoform	CHI ₃	9.25	Yes	+
iodomethane	CH ₃ I	9.54	Yes	0.2 – 0.3
Isoamyl acetate	C ₇ H ₁₄ O ₂	10	Yes	1.9 – 2.3
isobutane	C ₄ H ₁₀	10.57	Yes	+
isobutanol	C ₄ H ₁₀ O	10.12	Yes	+
isobutyl acetate	C ₆ H ₁₂ O ₂	9.9	Yes	2.4 – 2.8
isobutyl acrylate	C ₇ H ₁₂ O ₂		Yes	1.4 – 1.6
Isobutylene	C ₄ H ₈	9.24	Yes	1.0
isobutyraldehyde	C ₄ H ₈ O	9	Yes	+
Isooctane (Naphtha)	C ₈ H ₁₈	9.86	Yes	1.1
Isooctyl alcohol	C ₈ H ₁₈ O	9	Yes	+
Isopentane	C ₅ H ₁₂	10.32	Yes	+
Isophorone	C ₉ H ₁₄ O	9.07	Yes	+
Isoprene	C ₅ H ₈	8.85	Yes	0.6 – 0.7
Isopropanol	C ₃ H ₈ O	10.17	Yes	5.9
Isopropyl acetate	C ₅ H ₁₀ O ₂	9.99	Yes	2.4 – 2.8
Isopropyl alcohol	C ₃ H ₈ O	10.17	Yes	5.9
Isopropyl chloroformate	C ₄ H ₇ O ₂ Cl		Yes	+
Isosafrole	C ₁₀ H ₁₀ O ₂		Yes	+
Jet Fuel JP-4		9	Yes	0.9 – 1.1
Jet Fuel JP-5		9	Yes	0.6 – 0.7
Jet Fuel JP-8, Jet A1		9	Yes	0.6
Kerosene		9	Yes	1.1

Table 26. Other PID Gases

Gas Name	Formula	Ionization Potential	Detectable by 10.6 eV Lamp	10.6 eV Lamp CF
Ketene	C ₂ H ₂ O	9.617	Yes	+
n-Limonene	C ₁₀ H ₁₆		Yes	0.7
Maleic anhydride	C ₄ H ₂ O ₃	9.9	Yes	+
Mesitylene	C ₉ H ₁₂	8.41	Yes	0.3 – 0.4
Methacrylic acid	C ₄ H ₆ O ₂	10.15	Yes	+
Methacrylonitrile	C ₄ H ₅ N	10.34	Yes	+
Methanol	CH ₄ O	10.85	No*	146.8
Methoxyethanol, 2-	C ₃ H ₈ O ₂	9.6	Yes	2.2 – 2.6
Methoxyethoxyethanol, 2-	C ₅ H ₁₂ O ₃	10	Yes	1.1 – 1.3
Methoxymethylethoxy-2-propanol	C ₆ H ₁₄ O ₃	9	Yes	+
2-methoxy-1-methylethyl acetate (PGMEA thinners)	C ₆ H ₁₂ O ₃		Yes	0.9 – 1.1
Methoxypropan-2-ol	C ₄ H ₁₀ O ₂	9	Yes	+
Methoxypropyl acetate	C ₆ H ₁₂ O ₃	9	Yes	+
Methyl acetate	C ₃ H ₆ O ₂	10.27	Yes	+
Methyl acrylate	C ₄ H ₆ O ₂	9.9	Yes	3.5 – 3.9
Methyl alcohol	CH ₄ O	10.85	No*	146.8
Methyl bromide	CH ₃ Br	10.54	Yes	1.5
Methyl ethyl ketone (MEK)	C ₄ H ₈ O	9.51	Yes	0.9
Methyl isobutyl ketone (MIBK)	C ₆ H ₁₂ O	9.3	Yes	0.8
Methyl isothiocyanate	C ₂ H ₃ NS	9.25	Yes	4.3 – 4.9
Methyl mercaptan	CH ₄ S	9.44	Yes	0.5 – 0.6
Methyl methacrylate	C ₅ H ₈ O ₂	9.7	Yes	3.5 – 3.9
Methyl oxirane	C ₃ H ₆ O	10.22	Yes	7.7
4-Methyl pentan-2-one	C ₆ H ₁₂ O	9.3	Yes	0.8
1-Methyl-prop-2-ene	C ₄ H ₈	9.24	Yes	1.0
Methyl n-propyl ketone (MPK)	C ₅ H ₁₀ O	9.39	Yes	0.9
Methyl salicylate	C ₈ H ₈ O ₃	9	Yes	0.9 – 1.0
Methyl sulphide	C ₂ H ₆ S	8.69	Yes	0.4 – 0.5
Methyl t-butyl ether (MTBE)	C ₅ H ₁₂ O	9.24	Yes	0.8
Methyl-2-propen-1-ol, 2-	C ₄ H ₈ O		Yes	+
Methyl-2-pyrrolidinone, N-	C ₅ H ₉ NO	9.17	Yes	0.8 – 0.9
Methyl-5-hepten-2-one, 6-	C ₈ H ₁₄ O		Yes	+
Methylamine	CH ₅ N	8.97	Yes	1.1 – 1.3
Methylbutan-1-ol, 3-	C ₅ H ₁₂ O	9.8	Yes	+
Methylcyclohexane	C ₇ H ₁₄	9.85	Yes	0.9 – 1.0

Table 26. Other PID Gases

Gas Name	Formula	Ionization Potential	Detectable by 10.6 eV Lamp	10.6 eV Lamp CF
Methylcyclohexanol, 4-	C ₇ H ₁₄ O	9.8	Yes	+
Methylcyclohexanone 2-	C ₇ H ₁₂ O	9	Yes	+
Methylheptan-3-one, 5-	C ₈ H ₁₆ O		Yes	+
Methylhexan-2-one, 5-	C ₇ H ₁₄ O	9.28	Yes	+
Methylhydrazine	CH ₆ N ₂	8	Yes	1.1 – 1.3
Methyl-N-2,4, 6-tetranitroaniline, N-	C ₇ H ₅ N ₅ O ₈	9	Yes	+
Methylpent-3-en-2-one, 4-	C ₆ H ₁₀ O	9	Yes	+
Methylpentan-2-ol, 4-	C ₆ H ₁₄ O	9	Yes	+
Methylpentane-2,4-diol, 2-	C ₆ H ₁₄ O ₂	9	Yes	+
Methylpropan-2-ol, 2-	C ₄ H ₁₀ O	9.7	Yes	+
Methylstyrene	C ₉ H ₁₀	8.2	Yes	0.5 – 0.6
Mineral spirits		9	Yes	0.7 – 0.8
Monochlorobenzene	C ₆ H ₅ Cl	9.07	Yes	0.4
Naphtha (iso-octane)	C ₈ H ₁₈	9.86	Yes	1.1
Naphthalene	C ₁₀ H ₈	8.14	Yes	0.4 – 0.5
Nitric oxide	NO	9.27	Yes	4.8 – 5.6
Nitroaniline 4-	C ₆ H ₆ N ₂ O ₂	8.85	Yes	+
Nitrobenzene	C ₆ H ₅ NO ₂	9.92	Yes	1.9
Nitrogen dioxide	NO ₂	9.75	No	-
Nitrogen trichloride	NCl ₃	10.22	Yes	+
Nonane, n-	C ₉ H ₂₀	9.72	Yes	1.5
Octane, n-	C ₈ H ₁₈	9.8	Yes	1.7
Octene, 1-	C ₈ H ₁₆		Yes	+
Oxirane	C ₂ H ₄ O	10.56	Yes	12.5
Oxydiethanol 2,2-	C ₄ H ₁₀ O ₃		Yes	+
Pentan-2-one	C ₅ H ₁₀ O	9.38	Yes	0.9
Pentan-3-one	C ₅ H ₁₀ O	9.31	Yes	+
Pentandione, 2,4-	C ₅ H ₈ O ₂	8.85	Yes	+
Pentane, n-	C ₅ H ₁₂	10.35	Yes	10.5
Phenol	C ₆ H ₆ O	8.51	Yes	0.9
Phenyl-2-propanone	C ₉ H ₁₀ O		Yes	+
Phenyl propene, 2-	C ₉ H ₁₀	8.35	Yes	+
Phenyl-2,3-epoxypropyl ether	C ₉ H ₁₀ O ₂	9	Yes	+
Phenylenediamine, p-	C ₆ H ₈ N ₂	6.89	Yes	+
Phosphine	PH ₃	9.96	Yes	3.7 – 4.1
Picoline, 3-	C ₆ H ₇ N	9.04	Yes	0.9 – 1.0

Table 26. Other PID Gases

Gas Name	Formula	Ionization Potential	Detectable by 10.6 eV Lamp	10.6 eV Lamp CF
Picric acid	C ₆ H ₃ N ₃ O ₇	9	Yes	+
Pinene, alpha	C ₁₀ H ₁₆	8.07	Yes	0.37
Pinene, beta	C ₁₀ H ₁₆	8	Yes	0.3 – 0.4
Piperidine	C ₅ H ₁₁ N	9	Yes	+
Piperylene	C ₅ H ₈	8.6	Yes	+
Prop-2-yn-1-ol	C ₃ H ₄ O	9	Yes	+
Propan-1-ol	C ₃ H ₈ O	10.2	Yes	5.9
Propan-2-ol	C ₃ H ₈ O	10.17	Yes	5.9
Propane-1,2-diol, total	C ₃ H ₈ O ₂		Yes	+
Propene	C ₃ H ₆	9.73	Yes	1.3 – 1.5
Propionaldehyde	C ₃ H ₆ O	9.95	Yes	1.8 – 2.0
Propionic acid	C ₃ H ₆ O ₂	10.24	Yes	+
Propyl acetate, n-	C ₅ H ₁₀ O ₂	10.04	Yes	+
Propylene	C ₃ H ₆	9.73	Yes	1.3 – 1.5
Propylene oxide	C ₃ H ₆ O	10.22	Yes	7.7
Propyleneimine	C ₃ H ₇ N	9	Yes	1.2 – 1.4
Pyridine	C ₅ H ₅ N	9.25	Yes	0.7 – 0.8
Pyridylamine 2-	C ₅ H ₆ N ₂	9	Yes	+
Pyrocatechol	C ₆ H ₆ O ₂	9	Yes	+
Resorcinol	C ₆ H ₆ O ₂	8.63	Yes	+
Safrole	C ₁₀ H ₁₀ O ₂		Yes	+
Styrene	C ₈ H ₈	8.4	Yes	0.46
Terpinolene	C ₁₀ H ₁₆		Yes	+
Tert-butanol	C ₄ H ₁₀ O	9.9	Yes	2.8 – 3.0
Tetrabromoethane, 1,1,2,2-	C ₂ H ₂ Br ₄		Yes	+
Tetracarbonylnickel	NiC ₄ O ₄	8.28	Yes	+
Tetrachloroethylene	C ₂ Cl ₄	9.326	Yes	0.52
Tetrachloronaphthalenes, all isomers	C ₁₀ H ₄ Cl ₄	9	Yes	+
Tetraethyl orthosilicate	C ₈ H ₂₀ O ₄ Si	9.8	Yes	0.7 – 0.8
Tetrafluoroethylene	C ₂ F ₄	10.12	Yes	+
Tetrahydrofuran	C ₄ H ₈ O	9.41	Yes	1.6 – 1.8
Tetrahydrothiophene	C ₄ H ₈ S	8.38	Yes	1.31
Therminol	C ₇ H ₈		Yes	0.7 – 0.8
Thiophane	C ₄ H ₈ S	8.38	Yes	1.31
Toluene	C ₇ H ₈	8.82	Yes	0.53
Toluene-2,4-diisocyanate	C ₉ H ₆ N ₂ O ₂	8.82	Yes	1.3 – 1.5

Table 26. Other PID Gases

Gas Name	Formula	Ionization Potential	Detectable by 10.6 eV Lamp	10.6 eV Lamp CF
Tributylamine	C ₁₂ H ₂₇ N		Yes	+
Trichlorobenzene 1,2,4-	C ₆ H ₃ Cl ₃	9.04	Yes	0.4 – 0.5
Trichloroethylene	C ₂ HCl ₃	9.45	Yes	0.53
Triethylamine	C ₆ H ₁₅ N	7.5	Yes	0.9 – 1.0
Trimethylamine	C ₃ H ₉ N	7.82	Yes	0.9 – 1.0
Trimethylbenzene mixtures	C ₉ H ₁₂	8.41	Yes	0.3 – 0.4
Trimethylbenzene, 1,3,5-	C ₉ H ₁₂	8.39	Yes	0.3 – 0.4
Trinitrotoluene 2,4,6-	C ₇ H ₅ N ₃ O ₆	10.59	Yes	+
Turpentine	C ₁₀ H ₁₆	8	Yes	0.45
TVOC			Yes	+
Undecane, n-	C ₁₁ H ₂₄	9.56	Yes	1.9 – 2.1
Vinyl acetate	C ₄ H ₆ O ₂	9.19	Yes	1.2
Vinyl bromide	C ₂ H ₃ Br	9.8	Yes	0.4 – 0.5
Vinyl chloride	C ₂ H ₃ Cl	9.99	Yes	2.0
Vinylethylene	C ₄ H ₆	9.07	Yes	0.9
Vinylidene chloride	Cl ₂ C ₂ H ₂	9.81	Yes	0.9
Vinyl-2-pyrrolidinone, 1-	C ₆ H ₉ NO		Yes	0.8 – 0.9
Xylene mixed isomers	C ₈ H ₁₀	8.56	Yes	0.5
Xylene, m-	C ₈ H ₁₀	8.56	Yes	0.5
Xylene, o-	C ₈ H ₁₀	8.56	Yes	0.5
Xylene, p-	C ₈ H ₁₀	8.44	Yes	0.5
Xylidine, all	C ₈ H ₁₁ N	7.5	Yes	+

*Some (very low) response with 10.6 eV lamp, not recommended for measurement

Table 26. Other PID Gases

Find out more

www.honeywellanalytics.com

Contact Honeywell Analytics:

Americas

Honeywell Analytics
405 Barclay Boulevard
Lincolnshire, IL 60069
USA
Tel: +1 847 955 8200
Toll free: +1 800 538 0363
Fax: +1 847 955 8208
detectgas@honeywell.com

Europe, Middle East, Africa

Life Safety Distribution AG
Wilstrasse 11-U11
CH-8610 Uster
Switzerland
Tel: +41 (0)44 943 4300
Fax: +41 (0)44 943 4398
gasdetection@honeywell.com

Technical Services

ha.global.service@honeywell.com

www.honeywell.com

Asia Pacific

Honeywell Analytics Asia Pacific
#508, Kolon Science Valley (1)
187-10 Guro-Dong, Guro-Gu
Seoul, 152-050,
Korea
Tel: +82 (0)2 2025 0307
Fax: +82 (0)2 2025 0329
analytics.ap@honeywell.com

Please Note:

While every effort has been made to ensure accuracy in this publication, no responsibility can be accepted for errors or omissions. Data may change, as well as legislation, and you are strongly advised to obtain copies of the most recently issued regulations, standards and guidelines. This publication is not intended to form the basis of a contract.

Honeywell

1998M0709 Rev 1

February 2008

© 2008 Honeywell Analytics