

# Tiger Select

Instrument User Manual V2.4



Register  
your instrument  
online to receive  
your extended  
warranty.

Unrivalled Detection.

[www.ionscience.com](http://www.ionscience.com)

## **Register your instrument online for extended warranty**

Thank you for purchasing your Ion Science instrument.

The standard warranty of your instrument can be extended to up to five years on PhoCheck Tiger and two years on other Ion Science instruments.

To receive your extended warranty, you must register your instrument online within one month of purchase (terms and conditions apply.)

Visit [www.ionscience.com/instrument-registration](http://www.ionscience.com/instrument-registration)



## Contents

---

<b>About this manual</b> .....	<b>4</b>
<b>Statements</b> .....	<b>5</b>
Responsibility of Use .....	5
Legal notice .....	5
Caution .....	5
Quality Assurance .....	5
Disposal .....	5
Calibration Facility .....	5
<b>Introduction</b> .....	<b>6</b>
<b>Lamp output</b> .....	<b>7</b>
<b>Filter tubes</b> .....	<b>8</b>
TAC mode .....	10
Soft keys available within TAC mode .....	10
Single log .....	10
Multi log .....	10
TAC .....	10
Tube mode .....	10
<b>Start up</b> .....	Error! Bookmark not defined.
H&S function (STEL calculation) .....	11
<b>Calibration</b> .....	<b>12</b>
Calibration type .....	12
Frequency of calibration .....	12
Demand and flow regulators .....	12
Calibration routine .....	13
<b>Calibration</b> .....	<b>14</b>
PID sensor access and batteries .....	17
<b>Parts list</b> .....	<b>18</b>
Probe assembly .....	18
<b>Contact details</b> .....	<b>19</b>
<b>Manual log</b> .....	<b>20</b>



## **About this manual**

---

This manual describes the function and operation of the Tiger Select instrument. It is a supplement to the standard Tiger user manual (part number: 861265)

Please read and understand both manuals completely before operating the Tiger Select instrument.



## Statements

---

### Responsibility of Use

Inadequate performance of the gas detection equipment described in this manual may not necessarily be self-evident and consequently equipment must be regularly inspected and maintained. Ion Science recommends that personnel responsible for equipment use institute a regime of regular checks to ensure it performs within calibration limits, and that a record be maintained which logs calibration check data. The equipment should be used in accordance with this manual, and in compliance with local safety standards.

### Legal notice

Whilst every attempt is made to ensure the accuracy of the information contained in this manual, Ion Science accepts no liability for errors or omissions, or any consequences deriving from the use of information contained herein. It is provided "as is" and without any representation, term, condition or warranty of any kind, either express or implied. To the extent permitted by law, Ion Science shall not be liable to any person or entity for any loss or damage which may arise from the use of this manual. We reserve the right at any time and without any notice to remove, amend or vary any of the content which appears herein.

### Caution

It is essential that the Tiger Select is always used with a supplied PTFE 0.5 micron filter fitted to the front of the instrument. Without a filter, particles of debris and dust can be drawn into the detector inhibiting the function of the instrument. These filters are consumable and should be changed after every 100 hours of use. The frequency of replacement should be increased for dusty or moisture laden environments. Filters are available from your distributor or at [www.ionscience.com](http://www.ionscience.com).

### Quality Assurance

Tiger Select has been manufactured in compliance with ISO9001:2000, which ensures that the equipment supplied to our customers has been designed and assembled reproducibly, from traceable components, and leaves Ion Science calibrated to stated standards.

### Disposal

Dispose of Tiger Select, its components and any used batteries in accordance with all local and national safety and environmental requirements. This includes the European WEEE (Waste Electrical and Electronic Equipment) directive. Ion Science Ltd offers a take back service. Please contact us for more information. The Tiger Select field case material is recyclable polypropylene.

### Calibration Facility

Ion Science Ltd offers a calibration service including the issue of certification confirming calibration with equipment traceable to national standards. A Tiger Select calibration kit is available from your distributor or service centre or at [www.ionscience.com](http://www.ionscience.com). Ion Science recommends annual return of all instruments for yearly service and calibration.



## Introduction

Benzene gas is a carcinogen often associated with petrochemical processing but it is also used as a solvent in the production of drugs, plastics, synthetic rubbers and dyes. Photo ionization detectors (PID) readily detect a wide range of VOC gases of which includes Benzene.

Gases that are cross sensitive to Benzene will result in significant errors in reading which are unacceptable when occupational exposure levels are set around 1ppm.

The Tiger Select has been developed to give an accurate and repeatable measurement of Benzene gas specifically to sub ppm levels.

The Tiger Select has two modes of operation; TAC mode which identifies the presence of Total Aromatic Compounds (which include Benzene), and Select mode which then identifies the specific Benzene content. This two stage approach avoids using filter tube unnecessarily; if there are no TAC gases present there is also no Benzene.

The Tiger Select uses a 10.0 eV light source so many of the gases associated with Benzene are ignored.

The remaining gases associated with Benzene are filtered using a Benzene pre-filter tube.

Note: n-Butane, n-Pentane, Ethylene, Propylene, Alcohol and Acetate are not shown on this illustration, however they are also beyond the detection range of the 10.0 eV lamp so are not detected.

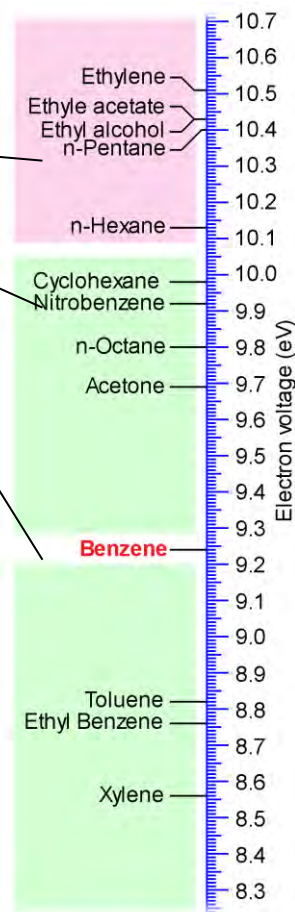



## Lamp output

---

The number of gases a PID can detectable directly relates to the Electron Voltage (eV) output of the PID lamp being used, the higher the eV level the more gases can be detected. In the standard PhoCheck Tiger the 10.6eV lamp allows the detection of over 450 gases. The Tiger Select still uses a 10.6 eV lamp however an additional 10.0 eV glass filter is fitted in to the electrode stack which limits the amount of detectable gases down to 115.

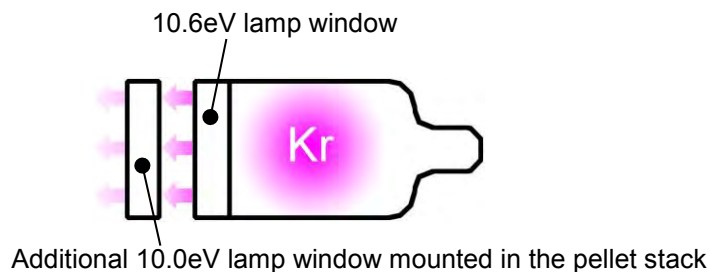

### **Important**

Always recalibrate the Tiger Select after servicing, particularly if the lamp or electrode stack is cleaned or replaced.



## Filter tubes

Benzene Pre filter tubes absorb many VOC gases however the Benzene content passes through. The gas sample must be drawn through the tube to condition it before the absorption level becomes stable. Please see the leaflet supplied with the pack of tubes for maximum absorption levels.

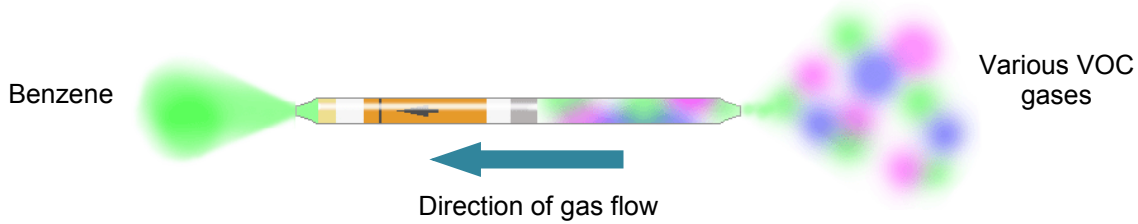

### Important

During the Benzene measurement, the Yellow/Orange indicating layer turns brown or green in the presence of other aromatic hydrocarbons and/or benzene hydrocarbons. If this colouring is longer than the  $\frac{3}{4}$  marking, the filter capacity of the tube is not sufficient anymore and the Benzene display may not be accurate.

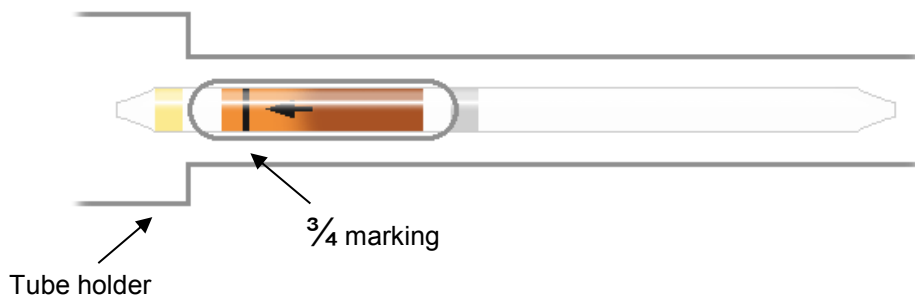





## **Fitting the tube holder**

---

Always ensure the filter tube is visible while viewing the display screen. If necessary the filter tube assembly should be removed and refitted.

1. Unscrew and remove the Filter Cap.



2. Remove the filter clamp and tube holder together.



3. Place the O'ring on the filter lamp and push the assembly in to the filter housing with the window facing forward. Continual pressure may be required to keep the assembly in place while tightening the filter cap.



The filter disk should be replaced if it appears dirty, or is disturbed from its seating position. The filter disks can be fitted either way round however the orientation should never be reversed once used.





## Start up

The Tiger Select will start up in either Standard running mode or TAC mode depending on the mode selected when it was switched off. In Standard running mode the instrument will work as a standard PhoCheck Tiger instrument. (See user manual part number: 861265).

Standard running mode has a default sensitivity of 0.1 ppm Isobutylene equivalent (EQ). If higher sensitivity (ppb) or data logging is required, upgrades can be purchased. Please contact your local distributor for further information.

### TAC mode

TAC mode automatically offers higher sensitivity, selects a response and allows data logging functionality. The Tiger Select can be left in this mode even through a power cycle or battery replacement.

TAC mode can only be used if a 10.0 eV lamp is selected.

The 10.0eV lamp output help filter out many VOC gases associated with Benzene.

#### **IMPORTANT**

The TAC gas used within TAC mode has a STEL set to 1 ppm, this level has been chosen based on the low STEL levels often associated with Benzene vapour. The Tiger Select TAC STEL however is not supported by nationally recognised bodies who publish official levels.

### Soft keys available within TAC mode

#### Single log

Single point data log allows individual readings to be logged in memory, logged data can then be downloaded to Tiger PC for review and analysis.

#### Multi log

Multiple data logging allows multiple readings to be logged in memory, logged data can then be downloaded to Tiger PC for review and analysis. The frequency of the data log and other log settings must be setup on the TigerPC configuration and sent to the instrument before use.

#### TAC

Pressing the TAC soft key simply enters and exits TAC mode.

#### Tube mode

Pressing the tube soft key simply enters tube mode

Please note: A tube calibration must be carried out before tube mode can be used. The following icon will appear until a Tube calibration is carried out. To carry out a tube calibration see page 13. Tube mode is designed to identify the level of Benzene gas after TAC mode has identified a significant background. Unlike the other modes of operation soft keys are unavailable during the Tube mode test.



**IMPORTANT:** When entering Tube mode the pump will stop until the test cycle begins. This is not a fault condition.

This mode of operation has two parts; an initial single point reading followed by an optional STEL calculation however both tests use the same pre-filter tube.

The initial Benzene test has a test time which varies with temperature. This test time is required to condition the tube which thereafter offer a proportional output relating to the Benzene being sampled.



A 15 minute STEL can then be carried out using the same tube, The STEL for Benzene will be automatically selected from the gas table. If a Benzene STEL is not specified within the selected gas table a figure can be entered on to the gas table and then sent to the instrument. To allow the table to be edited 'Allow inert/Delete' must be selected from the drop down Menu found in the top of the gas table screen.

### H&S function (STEL calculation)

The second stage of Tube mode is optional; to enable it select the H&S option on the configuration screen of Tiger PC and then sent to the instrument. (See below)

If selected a STEL calculation will automatically start calculating after the initial test.

The H&S icon will flash in the left corner of the screen, if the STEL measurement is required then the ENTER key.

If the H&S stage is not required then press the 'Esc' key, the instrument will offer the opportunity to fit another Benzene pre-filter tube to carry out another test.

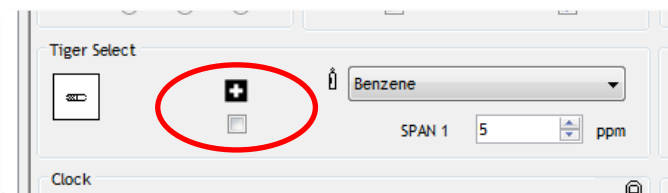



## Calibration

### Calibration type

Tiger Select has 3 calibration options:-

1. Factory calibration: This calibration is only used in normal running mode so is not used in TAC or Select mode. Factory Calibration is carried out at Ion Science during manufacture. This can be selected by the user but cannot be changed. Factory calibration should be carried out annually by Ion Science Ltd or an authorised service centre only.
2. Custom calibration: This calibration is used in normal running mode and TAC mode. Custom Calibration allows the user to calibrate the Tiger on alternative gases and using alternative concentrations.
3. Select calibration: The Tiger Select has a separate calibration set aside for tube mode. Please note that a tube calibration must be carried out before access to tube mode is allowed. Please see page 13.

The Select calibration settings can be adjusted on the configuration screen in Tiger PC. Benzene gas must be selected when using a Benzene pre filter however the calibration gas concentration can be adjusted.

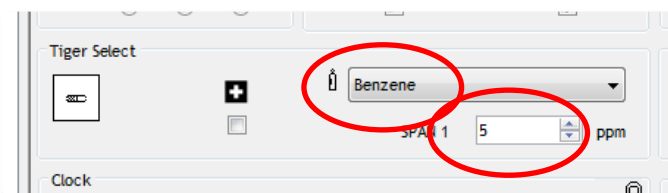

### Frequency of calibration

The frequency at which the Tiger Select is calibrated can vary considerably. Changes in environmental conditions, frequency of use or the gas being detected can all affect the accuracy of the instrument. Ion Science suggests customers carry out weekly calibrations but then extend this time as confidence is gained and any environmental effects identified.

Tiger Select should also be calibrated for the following reasons:-

- \* When a new batch of pre-filter tubes are used. Batch numbers can be found on the end of the tube carton.
- \* After servicing



### Demand and flow regulators

The Tiger Select can be calibrated using either a flow regulator or a demand regulator.

Demand regulators rely on the instrument pump drawing the sample from the gas bottle. These regulators supply exactly the amount of gas necessary to calibrate so are economical. They also avoid the risk of leaving the gas bottle switched on. Demand regulators however rely on the host instruments pump to draw the sample which causes a slight partial vacuum of between -7 to -10 mbar. For an accurate calibration the entire pneumatic system must be completely sealed.

Flow regulators supply a fixed amount of gas which should exceed what the instrument requires. A little gas is lost and the instrument takes what it needs. The Tiger Select requires 250 cc/min so flow regulators of 300 cc/min (0.3Lr/min) is advised. Being a flood leak the sample has the benefit of being matched to ambient air pressure.

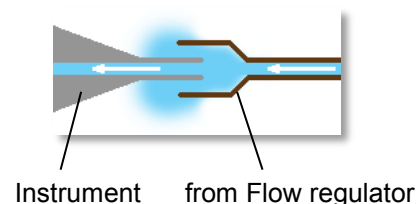



## Calibration

### Calibration routine

For best results place the Tiger Select instrument and any Benzene pre-filter tubes in the calibration environment. Switch the Tiger Select on and leave it running in the calibration environment for 30 minutes. This ensures the instrument and the tubes acclimatize to the environment and ensure any trace benzene is purged from the instrument after previous testing.

Tiger Select relies on a two point calibration to create its calibration factor. Both Zero and SPAN are set with a single stage. The Zero is set using initial slug of clean gas passing through a pre-filter tube, the span is set later. Please note the accuracy of the calibration will be affected by ambient temperature.

1. Select the settings soft key:



2. Choose the calibration option

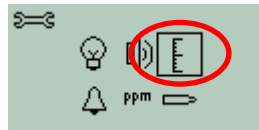

3. Choose the Tube calibration

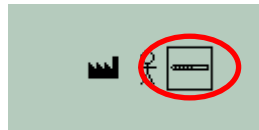

4. Use the up and down keys to adjust the temperature on screen to the ambient. Use a separate temperature measuring device if necessary.

Note: At this point the pump will stop running

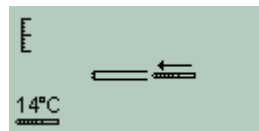

5. Remove both ends of the pre filter tube using the tube opener tool. This is done by inserting the tube in to the tube opener and twisting the tube. A slight angle may be required to cut the glass. Should the tube break up to the shoulder it must not be used as this will damage the seals within tube holder when inserted.



6. Unscrew the cap of the tube holder, insert the tube in to the tube holder cap ensuring the black arrow on the tube is pointing towards the open end (towards the instrument). Screw the tube holder cap and the tube on to the instrument.



- 6a. If using a flow regulator, remove the grub screw from the end of the tube holder cap before starting the calibration, this allows excess gas to escape.

**WARNING:** failing to allow excess pressure to escape could damage the Tiger Select pump.





## Calibration

---

7. Connect the calibration gas to the Probe by pushing the pipe on to the end of the tube holder.

**IMPORTANT:** For best results the pipe between the calibration gas and the instrument should be as short as practically possible.

9. If using a flow regulator; switch the gas on and then press the ENTER key to start the calibration routine. **IMPORTANT:** At the end of the test cycle switch off the calibration gas.

9a. If using a demand regulator just press the ENTER key to start the calibration routine.

The timer will count down, at the end of the calibration cycle a tick / check (✓) will appear.

Press the ENTER key to accept the calibration.

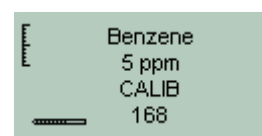



## TAC mode routine

The TAC soft key is used to ENTER and EXIT from TAC mode.

1. To select TAC mode press the TAC soft key then press then press the ENTER key to continue.

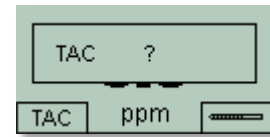

2. A tick / check '✓' will appear to confirm the selection



3. Press the Esc key to clear the confirmation

4. The TAC response factor will be displayed temporarily before entering TAC mode operation.



5. TAC mode automatically selects a specific instrument setup, to ensure best results. The TAC response factor, high sensitivity and data logging functions become available.

This mode offers single point data logging, multiple data logging, STEL and Tube mode.

### Important

The TAC gas used within TAC mode has a STEL set to 1 ppm, this level has been chosen based the low STEL levels often associated with Benzene gas. The Tiger Selects TAC STEL however is not supported by nationally recognised bodies who publish official levels

6. To exit TAC mode Press the TAC soft key and then ENTER.

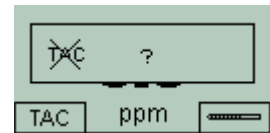

7. A tick / check '✓' will appear to confirm the selection, then press the Esc key.



8. The gas repose factor will be displayed temporarily before exiting TAC mode.

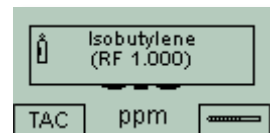





## Select mode routine

1. To enter Select mode press the Select soft key (  ) at this point the pump will stop running. A screen will appear to prompt the fitting of a pre-filter tube, this screen also indicates which gas is selected, ensure this is Benzene.

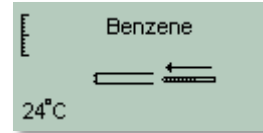

2. Adjust the on screen temperature to the ambient using the Up and Down keys. Preferred temperature units ( $^{\circ}\text{C}$  or  $^{\circ}\text{F}$ ) are set on the Configuration screen of TigerPC.

3. Remove both ends of the pre filter tube using the tube opener tool. This is done by inserting the tube in to the tube opener and twisting the tube. A slight angle may be required to cut the glass. Should the tube break up to the shoulder it must not be used as this will damage the seals within tube holder when inserted.



4. Unscrew the cap of the tube holder, insert the tube in to the tube holder cap ensuring the black arrow on the tube is pointing towards the open end (towards the instrument). Screw the tube holder cap and the tube on to the instrument.



5. Pressing the Enter key to start the test cycle. A count down timer will indicate the remaining test time, and a live Benzene reading is displayed. Please note that this live reading is for indication only. Only the final ready at the end of the test cycle should be used as a reference. This final reading will also be automatically data logged.

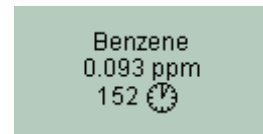

**WARNING: If the Benzene reading exceeds 200 ppm the reading should be treated with caution.**

Note, when using the Tiger Select to measure higher concentrations of Benzene the concentrations of other hydrocarbons may also be high and the Pre-filter's tube capacity should be considered. As the Pre-filters capacity is reached the tube will turn from a bright orange to "greenish brown". If the colour changes beyond the  $\frac{3}{4}$  marking the Benzene concentration displayed may not be accurate, see figure 2. If the colour turns past the  $\frac{3}{4}$  mark, as long as the benzene reading is below the test limit (e.g., 200 ppm) the result still within environmental compliance and the work activity can continue.

6. A 15 minute STEL can be carried out after the initial reading using the same pre-filter tube. Press the ENTER to continue or press the Esc key to return to the Tube test screen.



If H&S mode does not appear as an option it can be selected on the configuration screen of TigerPC in the Tiger Select section. The STEL threshold is taken from the internal gas table however some authorities have no published STEL level for Benzene so the instrument will not alarm.

7. At the end of the STEL test the instrument will display the final reading which will be data logged. Press the Esc key will return to TAC mode.

Pre-filter tubes must only be used for 1 single reading + 1 once STEL test only.

**WARNING: Should the level of Benzene through the filter tube exceed 200 ppm the accuracy of the reading should be approached with caution. Readings above 200 ppm are still displayed however '>200' flashes in the bottom left corner of the screen.**

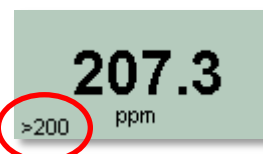

Important:

\* The working temperature range of the Benzene pre-filter is between 2 to 40  $^{\circ}\text{C}$ . (35  $^{\circ}\text{C}$  to 122  $^{\circ}\text{C}$ )





## Parts list

### PID sensor access and batteries

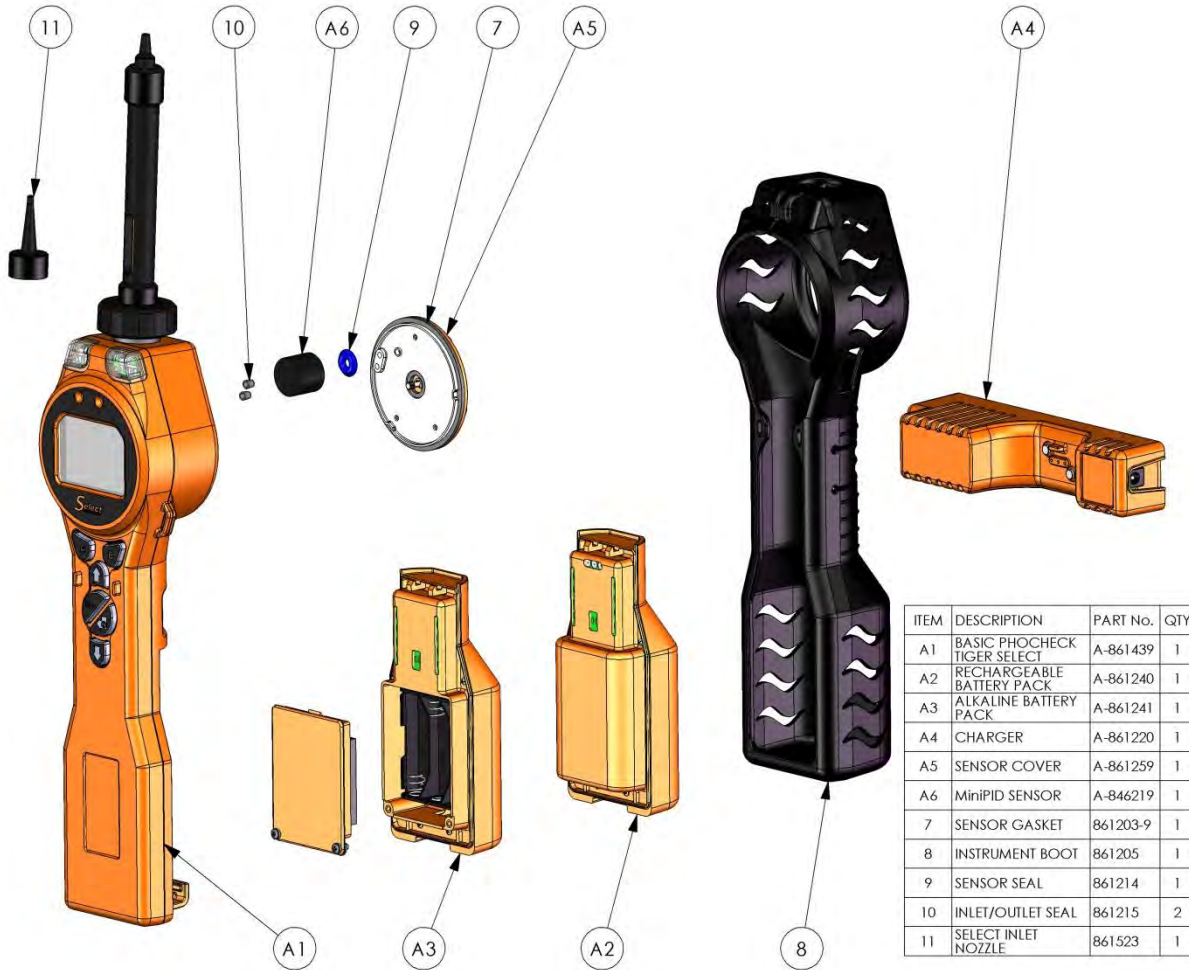

ITEM	DESCRIPTION	PART No.	QTY
A1	BASIC PHOCHECK TIGER SELECT	A-861439	1
A2	RECHARGEABLE BATTERY PACK	A-861240	1
A3	ALKALINE BATTERY PACK	A-861241	1
A4	CHARGER	A-861220	1
A5	SENSOR COVER	A-861259	1
A6	MiniPID SENSOR	A-846219	1
7	SENSOR GASKET	861203-9	1
8	INSTRUMENT BOOT	861205	1
9	SENSOR SEAL	861214	1
10	INLET/OUTLET SEAL	861215	2
11	SELECT INLET NOZZLE	861523	1



## Parts list

### Probe assembly

ITEM No.	DESCRIPTION	PART No.	QTY.
1	FILTER HOUSING CAP	861218	1
2	FILTER DISC	861221	1
3	SELECT INLET NOZZLE	861523	1
4	O-RING	5/OV-02	1
5	BENZENE PRE-FILTER TUBE	5/FD-01	1
6	TUBE HOLDER ASSEMBLY	A-861400	1

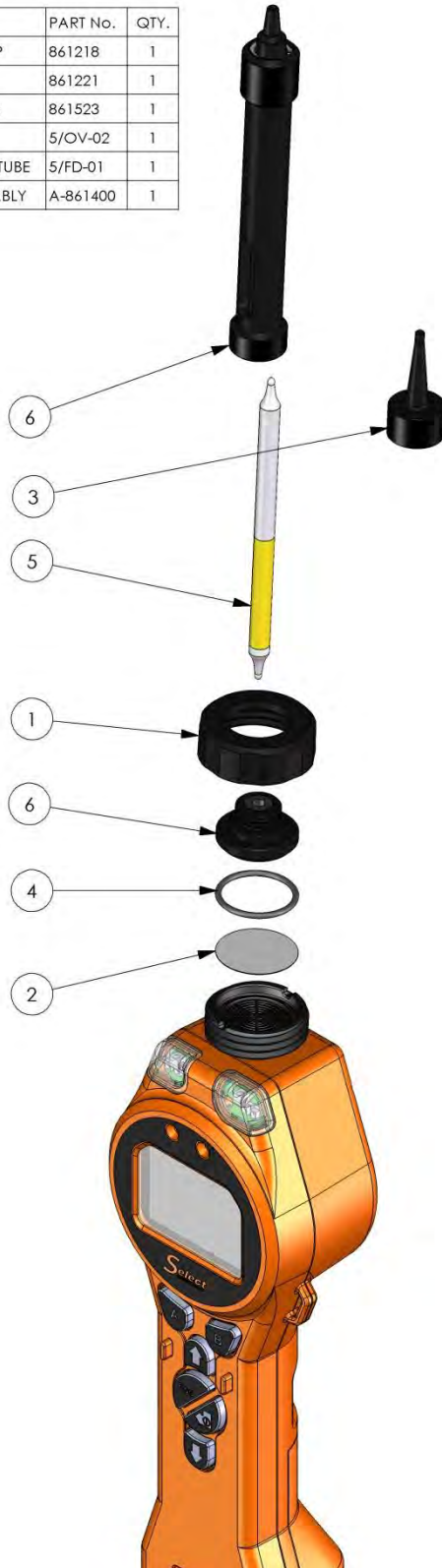



## Contact details

---

**UK Head Office**

Ion Science Ltd  
The Way, Fowlmere  
Cambridge  
SG8 7UJ  
UK

**Tel:** +44 (0)1763 207206

**Fax:** +44 (0) 1763 208814

**Email:** [info@ionscience.com](mailto:info@ionscience.com)

**Web:** [www.ionscience.com](http://www.ionscience.com)

**USA Office**

Ion Science LLC  
33 Commercial Drive  
Waterbury  
VT 05676  
USA

**Tel:** +1 802 244 5153

**Fax:** +1 802 244 8942

**Email:** [info@ionscienceusa.com](mailto:info@ionscienceusa.com)

**Web:** [www.ionscience.com](http://www.ionscience.com)

**German Office**

Ion Science Messtechnik GMBH  
Laubach 30  
Metmann-Neandertal  
40822  
GERMANY

**Tel:** +49 2104 14480

**Fax:** +49 2104 144825

**Email:** [info@ism-d.de](mailto:info@ism-d.de)

**Web:** [www.ism-d.de](http://www.ism-d.de)



## Manual log

---

Version	Amendment	Date of issue	Instrument firmware	PC software
1.0	First issue	27/02/2011	0.3.85	1.0.0.42
1.1	Front cover version. Page 9, Health and Safety mode added. Page 10 Health and Safety mode added.	8/04/2011	0.3.93	1.0.0.45
2.0	Completely restructured, also the addition of TAC mode	21/10/11	0.4.03	1.0.0.54
2.1	Tube holder changes Page 8, 9	01/03/12	0.4.04	1.0.0.58
2.2	Rewritten to include new software and firmware	23/08/12	0.4.17	1.0.0.63
2.3	Layout updated	29/01/2013	n/a	n/a
2.4	Benzene limit removed (>200ppm) various pages updated	22/04/2013	0.4.20	1.0.0.70