

MSA Altair™ Single Gas Detector

Operating Manual



In North America, to contact your nearest stocking location, dial toll-free 1-800-MSA-2222
To contact MSA International, dial 1-412-967-3354 or 1-800-MSA-7777

© MINE SAFETY APPLIANCES COMPANY 2006 - All Rights Reserved

This manual is available on the internet at www.msanet.com

Manufactured by

MSA INSTRUMENT DIVISION

P.O. Box 427, Pittsburgh, Pennsylvania 15230

(L) Rev 1

10068081

 **WARNING**

THIS MANUAL MUST BE CAREFULLY READ BY ALL INDIVIDUALS WHO HAVE OR WILL HAVE THE RESPONSIBILITY FOR USING OR SERVICING THE PRODUCT. Like any piece of complex equipment, this instrument will perform as designed only if it is used and serviced in accordance with the manufacturer's instructions. OTHERWISE, IT COULD FAIL TO PERFORM AS DESIGNED AND PERSONS WHO RELY ON THIS PRODUCT FOR THEIR SAFETY COULD SUSTAIN SEVERE PERSONAL INJURY OR DEATH.

The warranties made by Mine Safety Appliances Company with respect to the product are voided if the product is not used and serviced in accordance with the instructions in this manual. Please protect yourself and others by following them. We encourage our customers to write or call regarding this equipment prior to use or for any additional information relative to use or repairs.

Table of Contents

Chapter 1, Instrument Safety and Certifications1-1

▲ WARNING	1-1
Certifications	1-2

Chapter 2, Using the Altair Single Gas Detector2-1

Figure 2-1. Altair Overview	2-1
Figure 2-2. Altair Display	2-1
Changing Alarm Setpoints	2-1
To change Alarm setpoints before activation:	2-2
Figure 2-3. Changing the Alarm Setpoints	2-3
Activating the Altair Single Gas Detector	2-4
Figure 2-4. Altair Activation Flow Chart	2-6
Time Remaining (check before each day's use)	2-7
Confidence Indicator (see Figure 2-2)	2-8
Altair Alarms	2-8
Toxic Gas Measurements (see figure 2-1)	2-8
Oxygen Measurements	2-9
▲ WARNING	2-9
Accessing the Instrument Pages	2-10
Figure 2-5. Accessing Altair Pages Flow Chart ..	2-11
Event Logging	2-12

Chapter 3, Altair Function Checks3-1

Confidence and Heartbeat Indicator	3-1
Alarm Test	3-1
Bump Test	3-1
Table 3-1. Calibration/Bump Test Values	3-3
Figure 3-1. Bump Test Flow Chart	3-3

**Chapter 4,
Calibrating the Altair Single Gas Detector . . .4-1**

Calibrating the Toxic Gas Instruments (CO and H2S) . . .4-2
 ▲ WARNING4-3
 Figure 4-1. Calibration (Toxics) Flow Chart
 (part 1 of 2)4-4
 Figure 4-1. Calibration (Toxics) Flow Chart
 (part 2 of 2)4-5
Calibrating an Oxygen Instrument4-6
 Figure 4-2 Calibration (Oxygen) Flow Chart4-8

**Chapter 5,
Warranty, Maintenance, & Troubleshooting .5-1**

MSA Portable Instrument Warranty5-1
Troubleshooting5-2
 ▲ WARNING5-2
 Table 5-1. Troubleshooting Guidelines5-3

**Chapter 6,
Performance Specifications6-1**

Table 6-1. Certifications6-1
Table 6-2. Instrument Specifications6-2
Table 6-3. Event Logging Specifications6-3

**Chapter 7,
Replacement and Accessory Parts7-1**

Table -7-1. Replacement Parts List7-1

Chapter 1, Instrument Safety and Certifications

The Altair Single Gas Detector is:

- For use by trained, qualified personnel
- For use as a warning device only and not for measuring specific gas concentrations
- To be used when performing a hazard assessment to:
 - Assess potential worker exposure to Specific toxic gases for which a sensor is installed
 - Oxygen-deficient or oxygen-rich atmospheres

NOTE: Although the Altair unit will detect up to 25% oxygen, all Altair versions are not certified or classified for use in atmospheres containing more than 21.0% oxygen

WARNING

- Read and follow all instructions carefully.
- Do not use this detector to sample the instrument's specified gas in gases other than air.
- Perform an alarm function check and a bump test before each day's use. If the instrument fails either check, the instrument must be taken out of service.
- Recheck response and alarm function if the instrument is subjected to physical shock.
- The instrument is factory-sealed and contains no user serviceable parts. Substitution of components may impair intrinsic safety.
- This unit contains a lithium battery; dispose of according to local regulations.
- Do not rely on the vibrating alarm in cold temperatures (<0°C) as the vibrating alarm may cease to operate under these conditions.
- Use only to detect a gas for which a sensor is installed.
- Do not block sensor.
- Do not use pressurized air to clean the sensor holes.
- All instrument readings and information must be interpreted by someone trained and qualified in interpreting instrument readings in relation to the specific environment, industrial practice and exposure limitations.

**INCORRECT USE OR FAILURE TO FOLLOW THIS WARNING
CAN RESULT IN SERIOUS PERSONAL INJURY
OR DEATH.**

Certifications

The Altair Single Gas Detector meets applicable industry and government standards as indicated on the instrument Approval label and specified in TABLE 6-1.

Chapter 2, Using the Altair Single Gas Detector

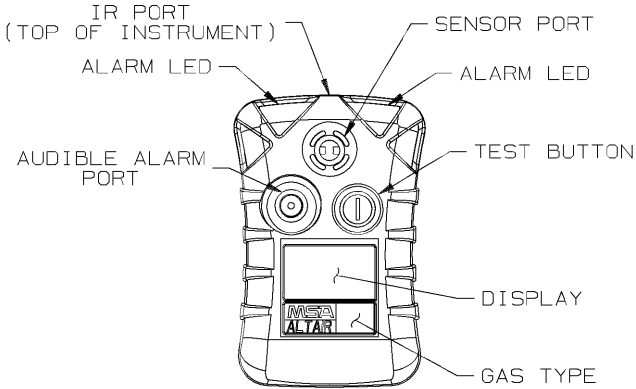

Figure 2-1. Altair Overview

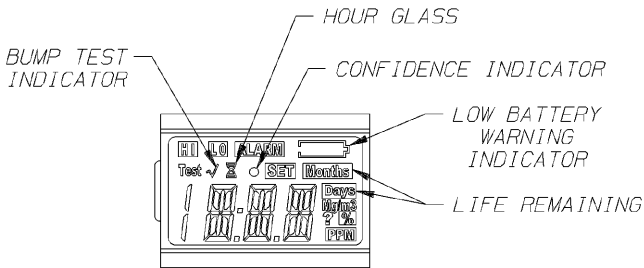

Figure 2-2. Altair Display

Changing Alarm Setpoints

NOTE: Alarm setpoints can only be changed manually during or before activation. Once the instrument is activated, the Alarm setpoints can be changed via the MSA FiveStar® LINK™ Software with IR communications.

To change Alarm setpoints before activation:

1. Press the "TEST" button once.
 - "TEST" displays.
 - After approximately one second, all segments and the LED activate.
 - The horn, LEDs, and vibrator also activate
 - The Software Version displays for three seconds ("CO", "H₂S", or "O₂").
2. Alarm Setpoints display the:
 - **Low Alarm Setpoint** for three seconds
 - LO and ALARM icons turn ON
 - a. To change the low alarm setpoint, press the TEST button when "LO" "ALARM" displays:
 - "LO" "ALARM" "SET" "?" displays.
 - b. Press and hold the TEST button to increment the low alarm value.
 - c. Once the correct value displays, release the TEST button and wait three seconds to continue.
 - **High Alarm Setpoint** for three seconds
 - HI and ALARM icons turn ON
 - a. To change the high alarm setpoint, press the TEST button when "HI" "ALARM" displays:
 - "HI" "ALARM" "SET" "?" displays
 - b. Press and hold the TEST button to increment the high alarm value.
 - c. Once the correct value displays, release the TEST button and wait three seconds to continue.
3. Wait three seconds.
 - the unit again turns OFF.

Activating the Altair Single Gas Detector

1. The unit must be activated before it can be used to warn the user of a potentially hazardous condition.
 - a. To activate the personal protection instrument, press and hold the TEST button for three seconds until "ON" and "?" are displayed.
 - b. Release the button and press once again to activate.
2. The following occurs:
 - an LCD Functional Test activates the cell segments
 - the horn, LEDs and vibrator also activate.
3. The Software Version displays for three seconds.
4. The instrument gas type displays for three seconds ("CO", "H₂S", or "O₂").
5. Alarm Setpoints display the:
 - **Low Alarm Setpoint** for three seconds
 - "LO" and "ALARM" icons turn ON
 - a. To change the low alarm setpoint, press the TEST button when "LO" "ALARM" display:
 - "LO" "ALARM" "SET" "?" displays.

- b. Press and hold the TEST button to increment the low alarm value:
 - Once the maximum setpoint allowed is reached, this value rolls over and begins again at the lowest value.
- c. Once the correct value displays, release the TEST button and wait three seconds to continue.
- **High Alarm Setpoint** for three seconds
 - "HI" and "ALARM" icons turn ON
 - a. To change the high alarm setpoint, press the TEST button when "HI" "ALARM" displays:
 - "HI" "ALARM" "SET" "?" displays.
 - b. Press and hold the TEST button to increment the high alarm value.
 - Once the maximum setpoint allowed is reached, this value rolls over and begins again at the lowest value.
 - c. Once the correct value displays, release the TEST button and wait three seconds to continue.
6. The instrument now performs a 99-second activation countdown.
 - Once activated, the instrument remains active until a Low Battery error occurs.
 - The Months Remaining counter begins at 24 months and counts down.

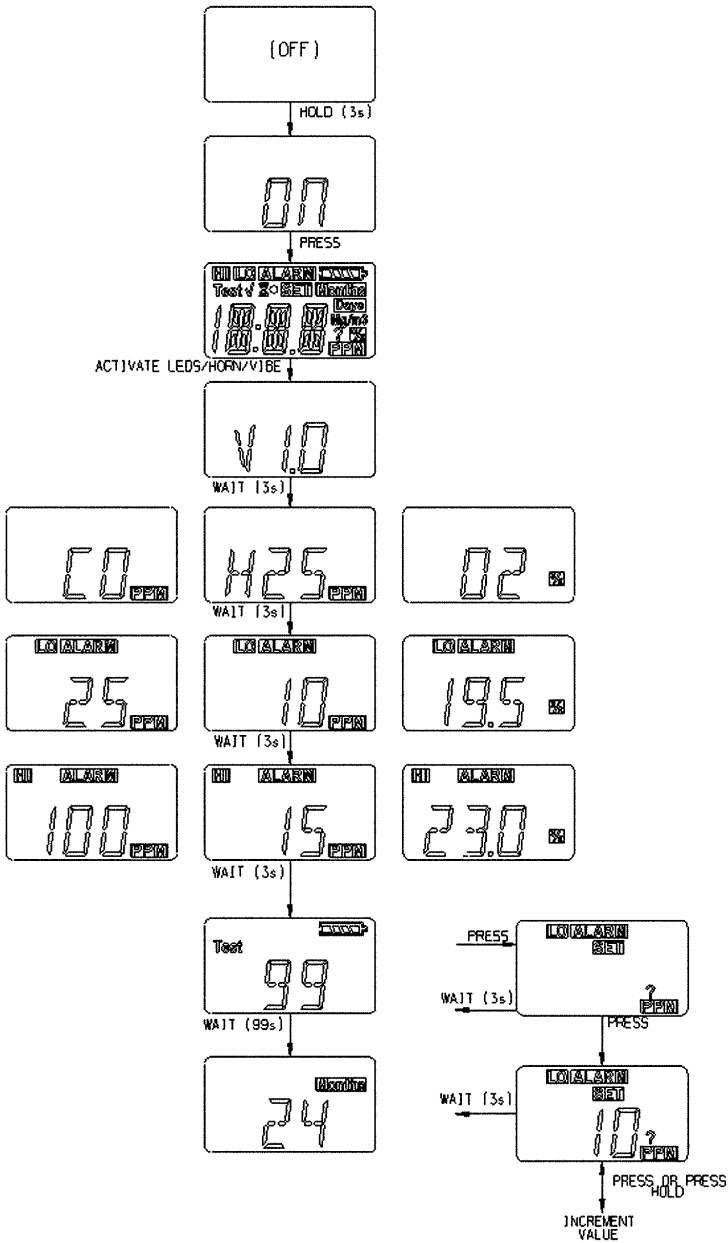

Figure 2-4. Altair Activation Flow Chart

Time Remaining (check before each day's use)

- In normal operating mode, the Altair Detector's remaining operating time (0 to 24 months) is always displayed.
- When less than one month remains, the display changes to the number of *days* remaining.
- The instrument is designed to continue to operate after 24 months have elapsed. A "+" followed by a numerical value and "months" or "days" indicates that more than 24 months have expired.
- For the instrument to function properly (including after the 24-month initial period has elapsed), the end user must continue to perform an alarm function check and bump test before each day's use.
- The instrument will continue to operate as long as:
 - The Low Battery warning indicator is not displayed
 - The instrument continues to pass the bump test as outlined in this manual.
- For the oxygen version:

If, after the initial 24-month period, the sensor output is less than 5% O₂ for more than five minutes, then it is considered a sensor failure:

- Instrument will display "SNS/ERR".
- If the battery reaches its end of life, the
 - **Low Battery warning** indicator activates:
 - User must discontinue using the Altair Single Gas Detector at this time, although the instrument is still detecting gas.
 - Low Battery indicator flashes
 - Months remaining continues to display.
 - **Low Battery alarm** activates:
 - Horn sounds
 - LEDs flash
 - Low Battery indicator flashes
 - "ERR" displays
 - Pressing the "TEST" button silences the alarm
 - Unit is no longer detecting gas and must be taken out of service.

Confidence Indicator (see FIGURE 2-2)

The Confidence indicator flashes once every 60 seconds to notify the user that the instrument is ON and operating normally. In addition, both LEDs will flash briefly every 60 seconds.

Altair Alarms

Toxic Gas Measurements (see FIGURE 2-1)

The Altair Detector can be purchased to detect the following gases in the atmosphere:

- Carbon Monoxide (CO) or
- Hydrogen Sulfide (H₂S).

There are two alarm setpoints in the instrument.

1. If the gas concentration reaches or exceeds the low alarm setpoint:
 - The instrument will:
 - display and flash "LO" and "ALARM" on the LCD
 - enter a low alarm sequence.
 - The low alarm can be silenced for five seconds by pressing the TEST button; it automatically clears once the gas level falls below the setpoint.
 2. If the gas concentration reaches or exceeds the high alarm setpoint:
 - The instrument will:
 - display and flash "HI" and "ALARM" on the LCD
 - enter a High alarm sequence.
 - The high alarm can be silenced for five seconds by pressing the TEST button; it automatically clears once the gas level falls below the setpoint.
- Refer to the instrument during Test mode for factory-set alarm setpoints.
 - If a gas concentration exceeds an alarm setpoint, the:
 - Audible alarm sounds
 - Alarm lights flash
 - Vibrator activates
 - Alarm type displays, alternately flashing the ALARM icon and the:
 - LO icon (if the low alarm setpoint was exceeded)
 - HI icon (if the high alarm setpoint was exceeded)

⚠ WARNING

If a toxic or oxygen gas alarm condition is reached while using the instrument as a personal or area monitor, leave the area immediately: the ambient condition has reached a pre-set alarm level. Failure to follow this warning will cause over-exposure to toxic gases, which can result in serious personal injury or death.

Oxygen Measurements

- The Altair Detector can be purchased to measure the concentration of oxygen in an atmosphere. High and Low alarm setpoints can be configured to alarm in any combination of oxygen:
 - enrichment (greater than 20.8%) or
 - depletion (less than 20.8%).
- When an alarm setpoint is reached, the:
 - Audible alarm sounds
 - Alarm lights flash
 - Vibrator activates
 - Type of alarm displays by alternately flashing the ALARM icon and the LO or HIGH icon, depending on how the Low and High alarms were set.
 - Low Alarm indicates:
 - the lower %O₂ level of the two alarm settings
 - a more urgent condition and the faster alarm sequence will be indicated
 - "LO" "ALARM" displays.

NOTE: False oxygen alarms can occur due to barometric pressure (altitude) changes or extreme changes in ambient temperature. It is recommended that an oxygen calibration be performed at the temperature and pressure of use. Be sure that the instrument is in known fresh air before performing a calibration.

Accessing the Instrument Pages

The Information page can be accessed by pushing the TEST button once. This information includes:

- 1) Current oxygen reading in % O₂ (oxygen versions only)
- 2) Test gas mode
- 3) Functional check of LCD, vibrator, LEDs and horn
- 4) Gas type
- 5) Low Alarm setpoint ("LO" "Alarm")
- 6) High Alarm setpoint ("HI" "Alarm")
- 7) Minimum Oxygen concentration ("LO") - for oxygen only
- 8) Peak Reading
 - Toxic ("HI")
 - Oxygen ("HI")
 - The Peak/Hi and Min/Low values can be cleared.
 - When this page is displayed, press the TEST button to clear.
 - "CLR" displays.
- 9) Alarm Time in hours (hour glass "HRS" and number of hours)
- 10) IR mode.
 - When instrument displays "IR?", press button to enter IR mode.
 - If IR communications are not detected for three minutes or the TEST button is pressed, the instrument will exit this mode.
 - See FIGURE 2-5 for additional details.

Figure 2-5. Accessing Altair Pages Flow Chart

Event Logging

- The Altair Single Gas instrument has the capability of recording 25 of the most recent events.

Press the TEST button.

- The instrument pages begin to display.
- Events will be transferred to the PC during this sequence, if:
 - the top of the instrument is pointed toward the optional IR Receiving device
 - a PC is running MSA FiveStar Link Software (P/N 710946)
 - "CONNECT" is pressed in the PC FiveStar LINK Software package.
- The following events are recorded:
 - Alarm - Alarm Type - Alarm Value - Time/Date
 - Alarm Clear - Alarm Type - Alarm Value - Time/Date
 - Cal (Pass/Fail) - Time/Date
 - Bump (Pass/Fail) - Time/Date
 - Error Non-Shutdown - Error Type (See Error List) - Time/Date
 - End of Life - Reason (Error - see Error List) - Time/Date.

NOTES:

- The time and date is based on the PC time and date. Ensure the PC is correct before the events are transferred.
- Instrument power loss can result in lost time in the session log.

Chapter 3, Altair Function Checks

Confidence and Heartbeat Indicator

- The alarm lights and heartbeat indicator on the display will flash approximately every 60 seconds to indicate that the Altair Detector is operating.

Alarm Test

- Check before each day's use.
- Press the TEST button momentarily. A one-second test of the alarms will occur; this includes the:
 - display
 - alarm lights
 - vibrator
 - horn.
- If these items do not activate, remove the instrument from service.

Bump Test

- Check before each day's use.
 - Press the TEST button momentarily:
 - oxygen versions will display the current oxygen reading; calibrate the unit if it reads other than 20.8%.
 - "TEST" "GAS" "?" will display.
 - alarm test will activate.
 - Press the TEST button again while "TEST" "GAS" "?" is displayed to activate the Bump Test mode.
 - the hourglass and "GAS" will display.
 - Apply gas only **AFTER** the hourglass and "GAS" are displayed.
 - If gas is detected, the display will indicate "OK".
- NOTE: See TABLE 3-1 for applied gases.

- Press the TEST button again:
 - The "√" that appears on the display:
 - indicates that the instrument passed the bump test.
 - remains for 24 hours, indicating that a bump test was performed on this instrument within the last 24 hours.

NOTE: See FIGURE 3-1 for details

- If the "√" does not appear and "ERR" is indicated:
 - Check that the:
 - sensor inlet is not clogged
 - correct calibration cylinder is used to perform the bump test
 - gas cylinder has not expired and is not empty
 - gas was applied at the appropriate time
 - gas tubing is seated in the front instrument case during testing.
 - Repeat the bump test process as needed.
- If the "√" does not appear, calibrate the instrument and repeat the Bump Test.

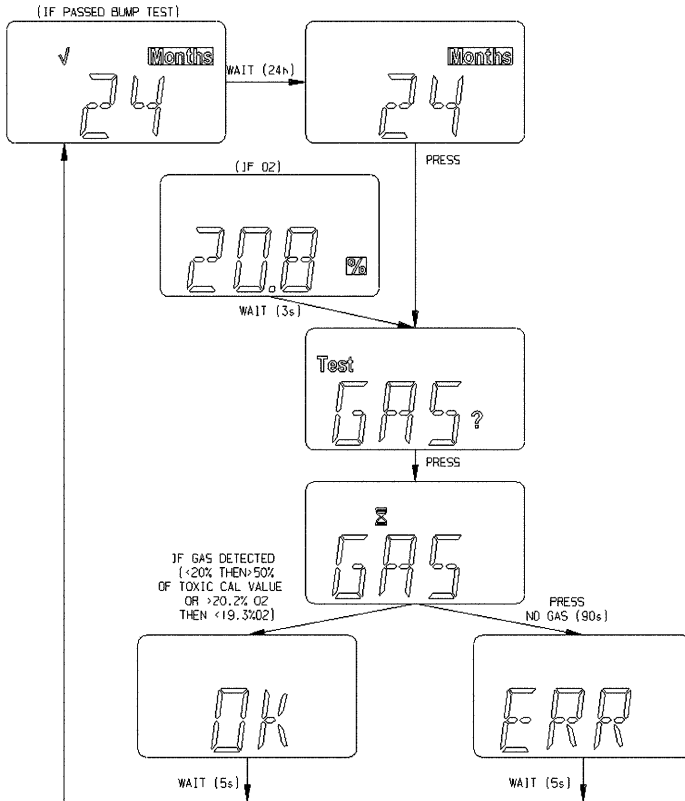

Figure 3-1. Bump Test Flow Chart

Table 3-1. Calibration/Bump Test Values

INSTRUMENT TYPE	BUMP TEST GAS	CALIBRATION GAS
CO	60 ppm	60 ppm
H ₂ S	40 ppm	40 ppm
O ₂	<19%*	20.8%

* The O₂ bump test can also be performed by exhaling on the sensor inlet for approximately three to five seconds.

Chapter 4, Calibrating the Altair Single Gas Detector

- The Altair Single Gas detector is designed to be a maintenance-free instrument, but it must be calibrated if it does not pass a Bump Test or if calibration is required by local procedures.
- For oxygen instruments, perform a calibration if:
 - there are changes in barometric pressure (altitude changes)
 - there are extreme changes in ambient temperature and humidity (see TABLE 6-2, "Instrument Specifications").
 - the instrument does not pass a bump test.
- For toxic instruments (CO and H₂S), perform a calibration if any of the following occur:
 - physical shock
 - extended use in extreme temperatures
 - high concentration exposure
 - the instrument does not pass a bump test.

Calibrating the Toxic Gas Instruments (CO and H₂S)

To enter the calibration mode, make sure you are in fresh, uncontaminated air. See FIGURE 4-1 for more details.

1. In normal operating mode, press the TEST button.
 - "TEST" "GAS" "?" displays.
2. Press and hold the TEST button for three seconds when the "TEST" "GAS" "?" displays.
 - "TEST" "CAL" screen displays
 - After three seconds, "FAS" "?" displays asking the user if a fresh air setup/calibration is desired.
3. Press the TEST button to enter zero calibration.

NOTE: Otherwise, the instrument will return to the normal operating mode.

4. During zero calibration:
 - the hour glass and "FAS" display
 - If the instrument successfully calibrates:
 - "OK" displays
 - If the instrument does not successfully calibrate:
 - "ERR" displays
 - instrument returns to normal operating mode after five seconds.
5. Once the instrument successfully calibrates and the "OK" displays, press the TEST button to enter calibration.
 - "CAL" "?" displays.
6. While the "CAL" "?" displays, press the TEST button to enter the Gas Calibration mode.
 - The current expected test gas is shown (in ppm).

- a. To change the expected calibration gas:
 - 1) Press the TEST button.
 - "TEST" "SET" "?" "ppm" displays.
 - 2) Press the TEST button again to set (hold the TEST button to scroll to a different value).
 - 3) Wait three seconds to return to the Calibration mode.
- b. Apply the appropriate test gas
 - The display toggles between the current gas reading, the hourglass and "CAL".
 - Once the instrument passes calibration (this will take no more than 90 seconds), "OK" displays.
 - Otherwise, "ERR" displays.
 - Wait five seconds to return to the normal operating mode.

⚠ WARNING

The expected gas concentrations must match the gas concentrations listed on the calibration cylinder(s). Failure to follow this warning will cause an incorrect calibration, which can result in serious personal injury or death.

- c. If "ERR" displays after calibration, the current settings did not change. Immediately check that:
 - The calibration cylinder matches the expected calibration value expected in the instrument
 - The calibration cylinder is not empty and has not expired.
 - The regulator is 0.25 liters/minute
 - The tubing is seated in the front instrument case during gas calibration mode.
 - If necessary, repeat steps 1 through 6.
 - The display must read "OK"; if "ERR" remains, remove the instrument from service.
- d. Perform a bump test to confirm operation and activate the "√".

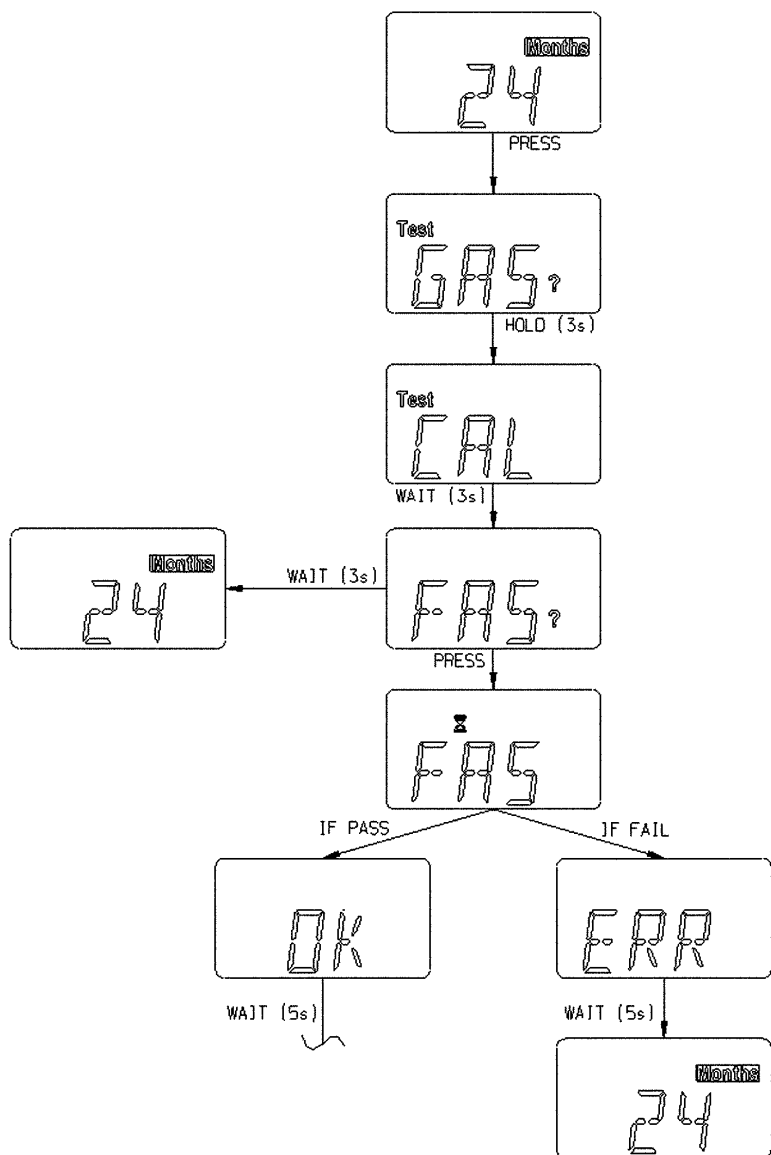

Figure 4-1. Calibration (Toxics) Flow Chart (part 1 of 2)

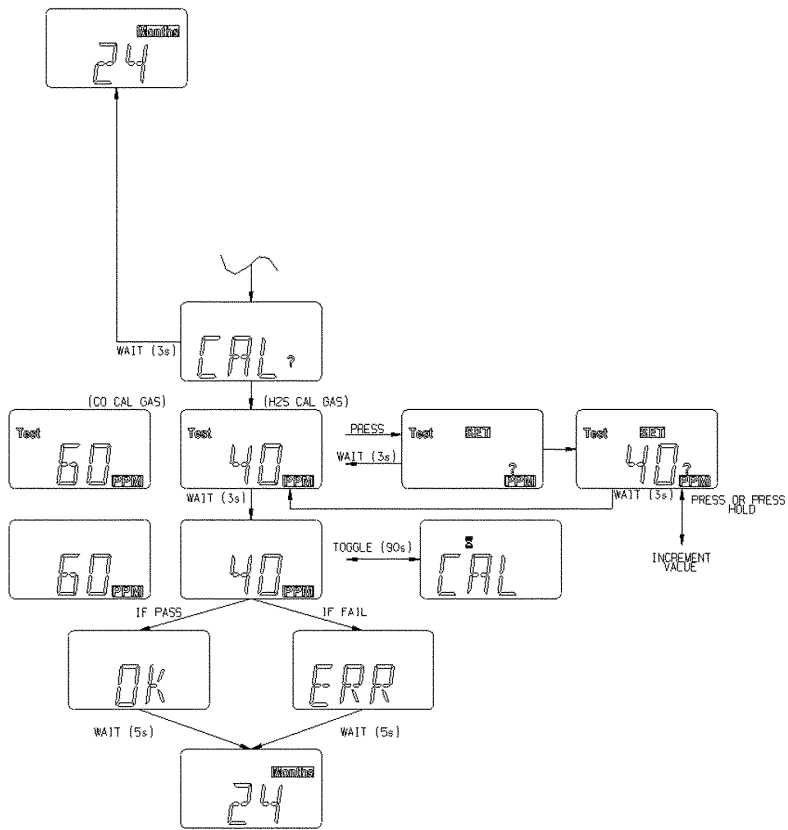

Figure 4-1. Calibration (Toxics) Flow Chart (part 2 of 2)

Calibrating an Oxygen Instrument

- False oxygen alarms can occur due to changes in barometric pressure (altitude changes) or extreme changes in ambient temperature.
- The Altair Detector is equipped with a feature to allow calibration at pressure and/or temperature of use.
- Be sure that the instrument is in known fresh air before performing a calibration.
- The Altair Oxygen instrument has the ability to display the current Oxygen level with a press of the TEST button. See Chapter 2, "Using the Altair Single Gas Detector" for more details. If this reading is other than 20.8%, a calibration is required in air that is known to be safe.

To enter the calibration mode, make sure you are in fresh, uncontaminated air.

1. In normal operating mode, press the TEST button.
 - The current Oxygen reading displays.
 - See FIGURE 4-2 for more details.
2. When the "TEST" "GAS" "?" displays, press and hold the TEST button to enter calibration.
 - "TEST" "CAL" displays
 - After three seconds, "FAS" "?" displays asking the user if a fresh air setup/calibration is desired.

3. Press the TEST button at the "FAS" "?" screen to perform a calibration at 20.8% O₂.

NOTE: This procedure must be performed in fresh, uncontaminated air. Do not breathe on the sensor while performing this function.

- If the successfully calibrates:
 - "OK" displays
 - If the sensor does not successfully calibrate:
 - "ERR" displays.
4. Wait five seconds.
 - The instrument returns to normal operating mode.
 5. If "ERR" displays after calibration, the current settings did not change. Immediately check that:
 - The instrument is in fresh, uncontaminated air during the calibration process
 - No one breathes on the sensor during calibration.
 - Repeat steps 1 through 6, as necessary.
 6. The display must read "OK"; if "ERR" remains, remove the instrument from service.
 7. Perform a bump test to confirm operation and activate the "√".

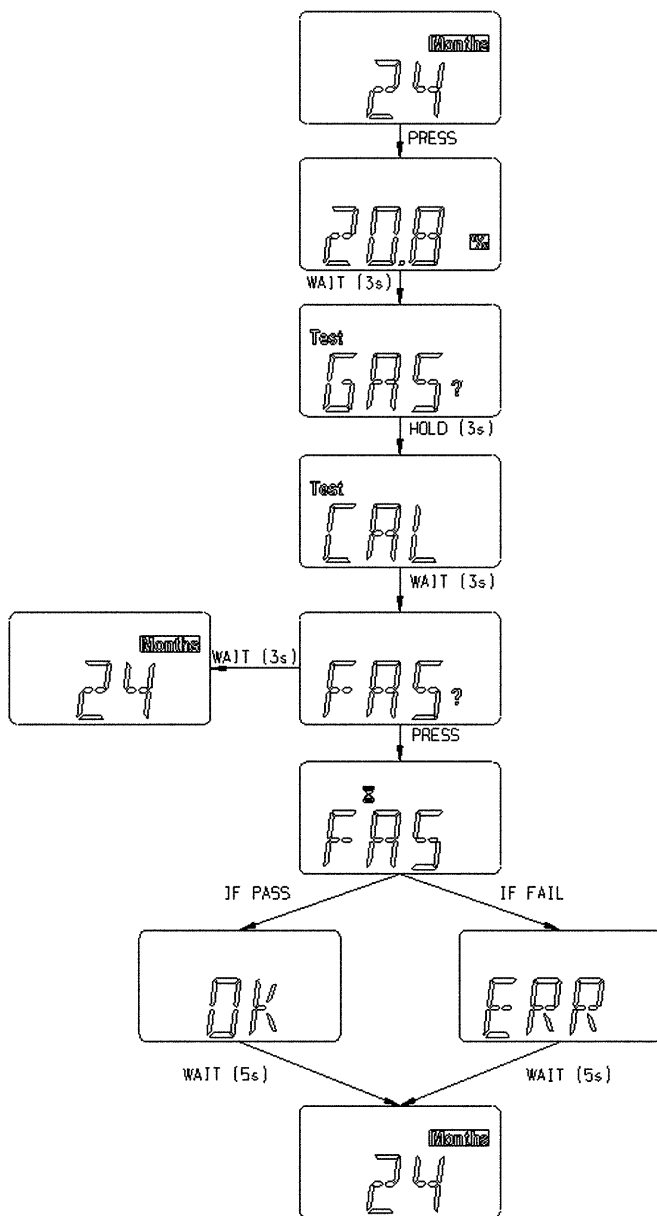

Figure 4-2 Calibration (Oxygen) Flow Chart

Chapter 5, Warranty, Maintenance, and Troubleshooting

MSA Portable Instrument Warranty

- 1. Warranty - MSA warrants that this product will be free from mechanical defects and faulty workmanship for a period of two (2) years from date of activation (given six months storage maximum before actuation from the date of manufacture or 18 hours total alarm time, whichever is first), provided it is maintained and used in accordance with MSA's instructions and/or recommendations. MSA shall be released from all obligations under this warranty in the event repairs or modifications are made by persons other than its own or authorized service personnel or if the warranty claim results from physical abuse or misuse of the product. No agent, employee or representative of MSA has any authority to bind MSA to any affirmation, representation or warranty concerning the goods sold under this contract. THIS WARRANTY IS IN LIEU OF ALL OTHER WARRANTIES, EXPRESSED, IMPLIED OR STATUTORY, AND IS STRICTLY LIMITED TO THE TERMS HEREOF. SELLER SPECIFICALLY DISCLAIMS ANY WARRANTY OF MERCHANTABILITY OR OF FITNESS FOR A PARTICULAR PURPOSE.**
- 2. Exclusive Remedy - It is expressly agreed that Purchaser's sole and exclusive remedy for breach of the above warranty, for any tortious conduct of MSA, or for any other cause of action, shall be the repair and/or replacement at MSA's option, of any equipment or parts thereof, which after examination by MSA is proven to be defective. Replacement equipment and/or parts will be provided at no cost to Purchaser, F.O.B. MSA's Plant. Failure of MSA to successfully repair any nonconforming product shall not cause the remedy established hereby to fail of its essential purpose.**
- 3. Exclusion of Consequential Damage - Purchaser specifically understands and agrees that under no circumstances will MSA be liable to Purchaser for economic, special, incidental or consequential damages or losses of any kind whatsoever, including but not limited to, loss of anticipated profits and any other loss caused by reason of non-operation of the goods. This exclusion is applicable to claims for breach of warranty, tortious conduct or any other cause of action against MSA.**

Troubleshooting

The Altair Single Gas Detector will operate reliably when handled properly. If the instrument becomes inoperative, follow the Troubleshooting Guidelines in TABLE 5-1; these represent the most likely causes of a problem. You may return inoperative instruments that are under warranty to MSA:

- **MSA Instrument Division
Repair and Service Department
1000 Cranberry Woods Drive
Cranberry Township, PA 16066-5207
1-800-MSA-INST**

To contact MSA International, please call:

- **1-412-967-3000 or 1-800-MSA-7777**



⚠ WARNING

Repair or alteration of the Altair Single Gas Detector, beyond the procedures described in this manual or by anyone other than a person authorized by MSA, could cause the instrument to fail to perform properly. Use only genuine MSA replacement parts when performing any maintenance procedures described in this manual. Substitution of components can seriously impair instrument performance, alter intrinsic safety characteristics or void agency approvals.

FAILURE TO FOLLOW THIS WARNING CAN RESULT IN SERIOUS PERSONAL INJURY OR DEATH.

The instrument displays an error code if it detects a problem during startup or operation. See TABLE 5-1 for a brief description of the error and proper corrective action.

Table 5-1. Troubleshooting Guidelines

PROBLEM	DESCRIPTION	ACTION
DISPLAY TOGGLES BETWEEN:		
TMP/ERR	Temperature out of range	Contact MSA during warranty period
AD/ERR	Sensor feedback error	Contact MSA during warranty period
EE/ERR	EEPROM inoperative	Contact MSA during warranty period
PRG/ERR	Program Memory inoperative	Contact MSA during warranty period
RAM/ERR	RAM inoperative	Contact MSA during warranty period
TMR/ERR	Time or Clock Error	Contact MSA during warranty period
BTN/ERR PWR/ERR	Button error (stuck down) Unexpected Power Loss Errors	Contact MSA during warranty period Contact MSA during warranty period
LED/ERR	LED inoperative	Verify operation of two alarm LEDs in alarm
VIB/ERR	Vibrator inoperative	Verify operation of vibrator in alarm
UNK/ERR	Unknown Error	Contact MSA during warranty period
UND/ERR	Sensor Under range	Calibrate instrument
	Low battery warning indicator (no alarm)	Remove from service
 /ERR	Low battery Alarm indicator (horn sounds, LEDs activate)	Remove from service
SNS/ERR	Sensor Error	Contact MSA during warranty period.

Chapter 6, Performance Specifications

Table 6-1. Certifications





HAZARDOUS LOCATIONS	US Exia	Class I Groups A, B, C, and D T _{amb.} -20 °C to +50°C Temperature Code T4
		
	CANADA	Exia Class I Groups A, B, C, and D T _{amb.} -20 °C to +50°C Temperature Code T4
		
	AUSTRALIA	Ex ia IIC T4 (Tamb 50°C)
	EUROPE	II 2G EEx ia IIC T4 -20 °C ≤ T _{amb.} ≤ +50°C
		
EMC/RFI	EUROPE	89/336/EEC
		
ENCLOSURE		IP 67
APPLICABLE EUROPEAN DIRECTIVES	EUROPE	ATEX: 94/9/EC EMC: 89/336/EEC LVD: 73/23/EEC

Table 6-2. Instrument Specifications

OPERATING TEMPERATURE RANGE	-20 to 50°C (-4 to +122°F) Internal vibrator operates to 0°C (32°F)		
HUMIDITY	10 to 95% RH, Non condensing		
INGRESS PROTECTION	IP67		
RECOMMENDED STORAGE	0 to 40°C (32° to 104°F)		
WARRANTY	2 years after activation, maximum or 18 hours alarm time when activated within 6 months after date of manufacture		
AUDIBLE ALARM	95 dB typical		
APPROXIMATE SIZE	3.4" H x 2.0" W x 1" D (8.6 cm H x 5.1 cm W x 2.5 cm D)		
WEIGHT	4 oz (113 grams)		
SENSOR	Electrochemical Sensors		
SENSOR DETECTION RANGE	H₂S	CO	O₂
	0-100 ppm	0-500 ppm	0-25% by volume
FACTORY-SET* ALARM SETPOINTS	LOW ALARM	HIGH ALARM	
	CO	25 PPM	100 PPM
	H₂S	10 PPM	15 PPM
	O₂	19.5%	23.0%
BATTERY	Lithium, non-rechargeable		
* Other setpoints available upon request. They may also be modified prior to activation through the button or at any time via MSA FiveStar Link Software.			
NOTE: This instrument has not been classified for use in atmospheres containing >21% oxygen.			

Table 6-3. Event Logging Specifications

NUMBER OF SHARED EVENTS	25 (most recent occurrences)
DATA TRANSMISSION METHOD	Via MSA infrared adapter on a PC using MSA FiveStar Link Software > version 4.3
EVENT LOG INFORMATION	<ul style="list-style-type: none">• Alarm - Alarm Type - Alarm Value - Time/Date• Alarm Clear - Alarm Type - Alarm Value - Time/Date• Cal (Pass/Fail) - Time/Date• Bump (Pass/Fail) - Time/Date• Error Non-Shutdown - Error Type (See Error List) - Time/Date• End of Life - Reason (Error - see Error List) - Alarm minutes - Months Life - Time/Date.
TRANSMISSION TIME	Typically < 60 seconds max.

Chapter 7, Replacement and Accessory Parts

Table -7-1. Replacement Parts List

PART/COMPONENT	PART NO.
Cylinder, 60 ppm CO	710882
Cylinder, 300 ppm CO RP	473180
Cylinder, 40 ppm H ₂ S, RP	467897
Cylinder, 40 ppm H ₂ S, Econocal	711062
Regulator, 0.25 lpm	467895
Regulator, 0.25 lpm, Combination	711175
Tubing, 40 cm (16")	10030325
Clip, Suspender Style, black	10040002
Clip, Suspender Style, Stainless Steel	10069894
Cell Phone Belt Clip	10041105
Lanyard Kit	10041107
FiveStar Link with IR (optional for event logging)	710946