



# FiveStar<sup>®</sup> Alarm

## Instruction Manual

### **WARNING**

**THIS MANUAL MUST BE CAREFULLY READ BY ALL INDIVIDUALS WHO HAVE OR WILL HAVE THE RESPONSIBILITY FOR USING OR SERVICING THE PRODUCT. Like any piece of complex equipment, this instrument will perform as designed only if it is used and serviced in accordance with the manufacturer's instructions. OTHERWISE IT COULD FAIL TO PERFORM AS DESIGNED AND PERSONS WHO RELY ON THIS PRODUCT FOR THEIR SAFETY COULD SUSTAIN SEVERE PERSONAL INJURY OR DEATH.**

The warranties made by Mine Safety Appliances Company with respect to the product are voided if the product is not used and serviced in accordance with the instructions in this manual. Please protect yourself and others by following them. We encourage our customers to write or call regarding this equipment prior to use or for any additional information relative to use or repairs.

### **CAUTION**

**For safety reasons, this equipment must be operated by qualified personnel only. Read and understand the instruction manual completely before operating.**

In the U.S., to contact your nearest stocking location, dial toll-free 1-800-MSA-2222. To contact MSA International, dial 1-412-967-3354 or 1-800-MSA-7777.

This manual pertains to:

North American approved instruments with Serial Number prefix "F" and "G"

Australian approved instruments with Serial Number prefix "A"

EN approved instruments with Serial Number prefix "A".

© MINE SAFETY APPLIANCES COMPANY 2005 - All Rights Reserved

Manufactured by  
**MSA INSTRUMENT DIVISION**  
P.O. Box 427, Pittsburgh, Pennsylvania 15230

# MSA Portable Instrument Warranty

## 1. Warranty-

ITEM	WARRANTY PERIOD
Chassis and electronics	Lifetime (MSA will support product for five years after production ends)
All sensors, unless otherwise specified	Two years
Pump and drive unit	Two years
Rechargeable batteries	Two years

This warranty does not cover filters, fuses, etc. Certain other accessories not specifically listed here may have different warranty periods. This warranty is valid only if the product is maintained and used in accordance with Seller's instructions and/or recommendations. The Seller shall be released from all obligations under this warranty in the event repairs or modifications are made by persons other than its own or authorized service personnel or if the warranty claim results from physical abuse or misuse of the product. No agent, employee or representative of the Seller has any authority to bind the Seller to any affirmation, representation or warranty concerning this product. Seller makes no warranty concerning components or accessories not manufactured by the Seller, but will pass on to the Purchaser all warranties of manufacturers of such components. **THIS WARRANTY IS IN LIEU OF ALL OTHER WARRANTIES, EXPRESSED, IMPLIED OR STATUTORY, AND IS STRICTLY LIMITED TO THE TERMS HEREOF. SELLER SPECIFICALLY DISCLAIMS ANY WARRANTY OF MERCHANTABILITY OR OF FITNESS FOR A PARTICULAR PURPOSE.**

- 2. Exclusive Remedy-** It is expressly agreed that Purchaser's sole and exclusive remedy for breach of the above warranty, for any tortious conduct of Seller, or for any other cause of action, shall be the repair and/or replacement at Seller's option, of any equipment or parts thereof, which after examination by Seller is proven to be defective. Replacement equipment and/or parts will be provided at no cost to Purchaser, F.O.B. Seller's Plant. Failure of Seller to successfully repair any nonconforming product shall not cause the remedy established hereby to fail of its essential purpose.
- 3. Exclusion of Consequential Damages-** Purchaser specifically understands and agrees that under no circumstances will seller be liable to purchaser for economic, special, incidental or consequential damages or losses of any kind whatsoever, including but not limited to, loss of anticipated profits and any other loss caused by reason of nonoperation of the goods. This exclusion is applicable to claims for breach of warranty, tortious conduct or any other cause of action against seller.

## Table of Contents

General Description .....	1-1
<b>▲</b> WARNINGS .....	1-1
<b>▲</b> CAUTIONS.....	1-4
Certifications .....	1-4
Electromagnetic Interference .....	1-4
General Limitations.....	1-5
Preparation .....	2-1
Battery Pack Installation .....	2-1
Figure 2-1. Battery Pack Installation .....	2-1
Figure 2-2. Serial Number and Software Version .....	2-2
Figure 2-3. Self Test.....	2-2
Figure 2-4. Setup Now - No/Yes?.....	2-2
Figure 2-5. Alternate Language Option .....	2-2
Figure 2-6. Scrolling through the Language Options	2-3
Figure 2-7. Operating Beep - No/Yes? .....	2-3
Figure 2-8. Peak STEL TWA?.....	2-3
Figure 2-9. Time and Date Set .....	2-4
Figure 2-10. Time Set .....	2-4
Figure 2-11. Time Set Complete .....	2-4
Figure 2-12. Date Set.....	2-5
Figure 2-13. Day, Month, Year .....	2-5
Turning ON the FiveStar Alarm.....	2-6
Figure 2-14. Date Set Complete .....	2-6
Figure 2-15. Show Alarms? .....	2-6
Figure 2-16. Setup Complete.....	2-6
Fresh Air Set Up Option <i>(for automatic zero adjustment of the FiveStar Alarm sensors)</i> .....	2-7
<b>▲</b> WARNING .....	2-7
Figure 2-17. Units Measured .....	2-7
Figure 2-18. Gases Measured .....	2-7
To Proceed With Fresh Air Setup: .....	2-8
To Bypass The Fresh Air Set Up: .....	2-8
Figure 2-19. Fresh Air Set-up .....	2-8

Figure 2-20. FAS Canceled/OK ..... 2-8

Using the FiveStar Alarm ..... 2-9

Exposure Display ..... 2-9

Figure 2-21. Exposure Page..... 2-9

Battery Condition ..... 2-10

Battery Conditions that can be displayed on the  
Battery Display Page: ..... 2-10

Figure 2-22. Gas Units ..... 2-10

Figure 2-23. Battery Condition ..... 2-10

Figure 2-24. Replaceable Battery Page..... 2-10

Approximate Voltage Readings for  
Replaceable Battery Pack Alarms ..... 2-11

▲ WARNING ..... 2-11

▲ WARNING ..... 2-11

▲ WARNING ..... 2-12

▲ CAUTION..... 2-12

▲ WARNING ..... 2-12

Time Display..... 2-12

Figure 2-25. Time Display..... 2-12

Measuring Gas Concentrations ..... 2-13

Combustible Gases (COMB) ..... 2-13

▲ WARNING ..... 2-13

Figure 2-26. Combustible Gas Alarm Flag ..... 2-13

Oxygen Measurements..... 2-14

▲ WARNING

Toxic Gas Measurement ..... 2-14

Figure 2-27. Oxygen Alarm Flag ..... 2-14

▲ WARNING ..... 2-15

Calibration Check ..... 2-15

Figure 2-28. Metal Calibration Cap Installation  
(Early Versions Only) ..... 2-15

Figure 2-29. Snap Calibration Cap Installation .... 2-15

Options..... 2-16

Optional Displays ..... 2-16

Peak Readings ..... 2-16

To reset the Peak Readings:..... 2-16

Figure 2-30. Peak Readings..... 2-16

Figure 2-31. Reset Peak Readings ..... 2-16

Short Term Exposure Limit (STEL).....	2-17
Figure 2-32. STEL Page .....	2-17
Figure 2-33. STEL Alarm Flag.....	2-17
▲ WARNING .....	2-18
Time Weighted Average (TWA) .....	2-18
Figure 2-34. Reset TWA Page .....	2-18
▲ WARNING .....	2-19
Datatagging Option.....	2-19
Setting a Tag .....	2-20
Autocalibration.....	2-20
Figure 2-35. Setting Tag Page.....	2-20
Figure 2-36. Last Data Tag Page .....	2-20
Figure 2-37. Editing Tag Page.....	2-20
Figure 2-38. Recording Tag Page.....	2-20
Table 2-1. Autocalibration Allowable Sensors & Required Calibration Cylinders.....	2-21
Figure 2-39. Auto Cal? YES/NO .....	2-21
Figure 2-40. Apply Cal Gas .....	2-21
Figure 2-41. Example of a Combustible Gas Reading	2-21
Figure 2-42. Auto Cal Fail Show/OK.....	2-22
Figure 2-43. Example of Expected Gas Values.....	2-22
Figure 2-44. Example of Expected Values with OK/LOW/HIGH .....	2-22
Turning OFF the FiveStar Alarm.....	2-23
Battery Pack Removal .....	2-23
▲ CAUTION.....	2-23
Optional Sampling Equipment .....	2-23
Figure 2-45. Power Down .....	2-23
Figure 2-46. Battery Pack Removal.....	2-23
PulseCheck™ Pump Module .....	2-24
Temporary Pump Installation.....	2-24
Permanent Pump Installation.....	2-24
Figure 2-47. PulseCheck Pump Module .....	2-24
Turn ON Instrument and Verify Proper Operation....	2-25
▲ WARNING .....	2-25
Figure 2-48. Pump Alarm.....	2-25
▲ CAUTION.....	2-26

FiveStar Alarm Aspirator Assembly . . . . .	2-26
▲ WARNING . . . . .	2-26
▲ WARNING . . . . .	2-27
Attaching the Aspirator Assembly . . . . .	2-27
Operation and Use . . . . .	2-27
▲ CAUTION . . . . .	2-28
Attaching Probe to Sampling Line . . . . .	2-28
Changing the Probe Filter . . . . .	2-28
Figure 2-49. Attaching Probe to Sample Line . . . . .	2-28
Figure 2-50. Changing the Probe Filter . . . . .	2-28
Removing Sampling Equipment . . . . .	2-29
Keying Series Red/Series Green Battery Packs . . . . .	2-29
▲ CAUTION . . . . .	2-29
Figure 2-51. Key for SERIES GREEN Battery Pack . . . . .	2-29
Recharging Ni-Cad and NiMH Battery Packs . . . . .	2-30
Figure 2-52. Ni-Cad Charger (120V version shown) . . . . .	2-30
Recharge Times . . . . .	2-31
Replaceable Battery Pack Instructions . . . . .	2-31
▲ CAUTION . . . . .	2-32
Figure 2-53. Battery and Fuse Location . . . . .	2-32
To Replace the Fuse . . . . .	2-33

## Chapter 3

### General Maintenance . . . . . 3-1

▲ WARNING . . . . .	3-1
Cleaning and Routine Care . . . . .	3-1
▲ CAUTION . . . . .	3-1
Figure 3-1. Sensor Cover Plate . . . . .	3-1
Storage . . . . .	3-2
Storage for Models with Nitric Oxide (NO) or Ammonia (NH <sub>3</sub> ) Sensors . . . . .	3-2
▲ WARNING . . . . .	3-2
Shipment . . . . .	3-2
Checking the Pump and Aspirator Inlet Filter . . . . .	3-3
Replacing the Filters . . . . .	3-3
Dust Filter . . . . .	3-3
Water Filter . . . . .	3-4
Internal "Firewall" Filter - Pump Module . . . . .	3-4

Instrument Specifications ..... 4-1

    Table 4-1. Instrument Specifications ..... 4-1

    Measurement Methods ..... 4-1

    Capacity Reductions Expected for Batteries  
    at Colder Temperatures ..... 4-2

    Approximate Battery Run Times ..... 4-2

Combustible Gas Sensor Specifications ..... 4-3

    Table 4-2. COMBUSTIBLE GAS - Typical  
    Performance Specifications ..... 4-3

    Table 4-3. COMBUSTIBLE GAS -  
    Cross Reference Factors for FiveStar  
    General-Purpose Calibration  
    Using Calibration Cylinder (P/N 478191),  
    (P/N 478192), (P/N 804769), or (P/N 804770)  
    Set to 58% LEL ..... 4-3

    Oxygen Sensor Specifications ..... 4-4

    Environment and Oxygen Sensor Readings ..... 4-4

    Pressure Changes ..... 4-4

    Humidity Changes ..... 4-4

        Table 4-4. OXYGEN -  
        Typical Performance Specifications ..... 4-4

Carbon Monoxide Sensor Specifications ..... 4-5

    Table 4-5. CARBON MONOXIDE  
    (appropriate models only) -  
    Typical Performance Specifications ..... 4-5

    Table 4-6. - CARBON MONOXIDE -  
    Cross Reference Factors  
    for FiveStar Calibration  
    Using Calibration Cylinder (P/N 478191)  
    or (P/N 804770) ..... 4-5

Hydrogen Sulfide Sensor Specifications ..... 4-6

    Table 4-7. HYDROGEN SULFIDE  
    (appropriate models only) -  
    Typical Performance Specifications ..... 4-6

    Table 4-8. HYDROGEN SULFIDE -  
    Cross Reference Factors  
    for FiveStar Calibration Using Calibration Cylinder  
    (P/N 804769) or (P/N 804770) Set to 10 ppm H<sub>2</sub>S. 4-6

Nitric Oxide Sensor Specifications ..... 4-7

Table 4-9. NITRIC OXIDE  
(appropriate models only) - Typical Performance  
Specifications . . . . . 4-7

Table 4-10. NITRIC OXIDE-  
Cross Reference Factors  
for FiveStar Calibration  
Using Calibration Cylinder (P/N 812144)  
Set to 50 ppm NO . . . . . 4-7

Nitrogen Dioxide Sensor Specifications . . . . . 4-8

Table 4-11. NITROGEN DIOXIDE  
(appropriate models only) -  
Typical Performance Specifications . . . . . 4-8

Table 4-12. NITROGEN DIOXIDE -  
Cross Reference Factors  
for FiveStar Calibration  
Using Calibration Cylinder (P/N 808977)  
Set to 10 ppm NO<sub>2</sub> . . . . . 4-8

Sulfur Dioxide Sensor Specifications . . . . . 4-9

Table 4-13. SULFUR DIOXIDE  
(appropriate models only) -  
Typical Performance Specifications . . . . . 4-9

Table 4-14. SULFUR DIOXIDE -  
Cross Reference Factors  
for FiveStar Calibration  
Using Calibration Cylinder (P/N 808978)  
Set to 10 ppm SO<sub>2</sub> . . . . . 4-9

Ammonia Sensor Specifications . . . . . 4-10

General Information . . . . . 4-10

Zero Stability (FIGURE 4-1) . . . . . 4-10

Table 4-15. AMMONIA (appropriate models only)  
Typical Performance Specifications . . . . . 4-10

Table 4-16. AMMONIA Cross Reference Factors . 4-11

Figure 4-1. Ammonia Sensor Zero Stability . . . . . 4-11

Phosphine Sensor Specifications . . . . . 4-12

Table 4-18. PHOSPHINE -  
Cross Reference Factors  
for FiveStar General-Purpose Calibration  
Using Calibration Cylinder (P/N 478191),  
(P/N 478192), (P/N 804769), or (P/N 804770)  
Set to 58% LEL . . . . . 4-12

Table 4-17. PHOSPHINE  
(appropriate models only)  
Typical Performance Specifications . . . . . 4-12

Chlorine Sensor Specifications . . . . . 4-13

Special Instructions . . . . . 4-13

Table 4-19. CHLORINE Typical Performance  
Specifications. . . . . 4-13

Table 4-20. CHLORINE -  
Cross Reference Factors  
for FiveStar Calibration  
Using Calibration Cylinder (P/N 806740)  
Set to 10 ppm. . . . . 4-13

▲ WARNING . . . . . 4-14

Chlorine Dioxide Sensor Specifications . . . . . 4-15

Special Instructions . . . . . 4-15

Table 4-22. CHLORINE DIOXIDE -  
Cross Reference Factors  
for FiveStar Calibration  
Using Calibration Cylinder (P/N 806740)  
Set to 4.95 ppm . . . . . 4-15

Table 4-21. CHLORINE DIOXIDE  
Typical Performance Specifications . . . . . 4-15

▲ WARNING . . . . . 4-16

**Chapter 5**  
**Accessories Parts List . . . . . 5-1**

Table 5-1. Parts List. . . . . 5-1

Table 5-2. Battery Pack and Charger Parts List. . . . . 5-2

# Chapter 1

## Safety and General Limitations

### General Description

**It is your responsibility to know how to use the FiveStar Alarm.** When used properly, the FiveStar Alarm will alert you to the presence of combustible gases and vapors and to atmospheres that are rich or deficient in oxygen. It will also alert you to the presence of specific toxic gases if it is equipped with sensors for those gases. These conditions are displayed clearly and simultaneously on the face of the instrument.

#### WARNINGS

- The FiveStar Alarm detects gases and vapors in air only. It cannot measure combustible or toxic gases in:
  - reducing atmospheres
  - furnace stacks
  - environments with inert gas backgrounds
- Do not use the FiveStar Alarm to measure combustible or toxic gases when the amount of oxygen is:
  - deficient
  - enriched
- The FiveStar Alarm measures combustible gases and vapors. It cannot measure the presence of combustible:
  - airborne mists such as lubricating oils
  - airborne dusts such as grain or coal dust
- The FiveStar Alarm contains sensors which detect specific toxic gases. The instrument must be used to detect only those specific gases. Other toxic hazards may be present; the FiveStar Alarm is not intended to detect these other hazards.

- Certain materials such as:
  - silicone
  - silicates
  - lead-containing compounds such as leaded gasoline
  - hydrogen sulfide (H<sub>2</sub>S) above 50 ppm for one minute or any exposure over 200 ppm

tend to desensitize the combustible gas sensor, thereby giving erroneously low readings. Calibration checks must be made frequently if such materials are suspected to be present in the tested atmosphere; otherwise, the instrument may give false readings and endanger life or health.

- It is important that such information obtained with the instrument be appraised by someone skilled or experienced in interpreting the instrument reading intelligently in the light of environment, industrial practice, and exposure. For example, an atmosphere that is indicated as non-hazardous from the standpoint of fire and explosion may, if inhaled, be toxic to workmen who are exposed for some time. Similarly, a vessel which is safe before work is started may be rendered *explosive* by future operations (for example, stirring or handling bottom sludge in a petroleum storage tank). The latter example indicates the need for frequently repeated or continuous tests of questionable spaces while work is in progress.

The instrument will respond to those concentrations of gases or vapors which are presented to the sensors. If the combustible is a high boiling point solvent and is tested at normal ambient temperature, a relatively low vapor concentration will be shown by the instrument. If the container holding such solvents is subsequently heated as by welding and soldering, it is to be expected that the vapor concentration will increase, and thus the atmosphere of a vessel which was originally shown to contain only a low concentration of vapors may be rendered explosive.

If an attempt is made to use such instruments for testing atmospheres contaminated with high boiling point solvents where the questionable space is at a higher temperature than the instrument, it can be anticipated that there may be some condensation of the combustible vapors in the sampling line and in the flow system of the instrument if used; as a consequence, the instrument may indicate less than the true

concentration of vapors. In general, combustible gases with flash points above 100°F do not give off enough vapors, at ambient temperatures, to be detected.

- When using a sampling pump and sample lines, the user must wait the appropriate time for gas to be drawn through the sample system to the sensors. Typical transport times are a maximum of 0.3 seconds per foot of sample line.
- When sampling over liquids, the end of the sampling line must not touch the surface of the liquid. Otherwise, liquids may enter the instrument, block sample gas from entering the line, and cause a false reading to occur. In addition, internal damage to the instrument may result.
- Obstruction of the sensor holes in the instrument case causes erroneous readings. These holes must be kept open at all times. Do not use compressed air to clean the sensor holes; excessive pressure at the face of the sensors could damage them.
- Do not use MSA Lead Inhibitor Filters with this instrument. Loss of sensitivity can result.
- Battery packs must be recharged in a non-hazardous location free of combustible gases and vapors.
- A calibration check must be performed before each day's use to verify that the instrument is operating properly and readings are accurate (or more frequently if the instrument is subjected to significant physical shock or high levels of contaminants). If the readings are not within the specified limits, the instrument must be recalibrated before use. If no calibration check is performed, inaccuracies in gas readings may not be detected. See the FiveStar Alarm Technical Manual, Chapter 2, for calibration check procedure.
- Use only genuine MSA replacement parts when performing any maintenance procedures described in this manual. Substitution of components can seriously impair instrument performance, alter intrinsic safety characteristics, or void agency approvals.
- Repair or alteration of the FiveStar Alarm beyond procedures in this manual or by anyone other than a person authorized by MSA could cause the instrument to fail to perform properly.

**FAILURE TO FOLLOW THE ABOVE WARNINGS CAN RESULT IN SERIOUS PERSONAL INJURY OR DEATH.**

## **⚠ CAUTIONS**

- When sampling with accessory sampling lines, the shortest possible length should be used to minimize the time needed to obtain a valid reading.
- Acid gases, such as carbon dioxide, will shorten the service life of the oxygen sensor.
- Do not push on the center of the oxygen or the toxic gas sensor. Be especially careful when installing or replacing a sensor. Damage to the sensor may result.
- This instrument is designed for use only with the battery chargers listed in this manual. Use of other battery chargers may result in damage to the battery pack and instrument.
- Before each day's use, perform a calibration check (see Chapter 2, "Calibration Check") and check the pump (if used) for proper operation. (See Chapter 2, "Pump Operation.")
- Changes or modifications to this unit not expressly approved by the party responsible for compliance could void the user's authority to operate the equipment.
- Dispose of used batteries in accordance with local health and safety regulations.
- This instrument generates, uses and can radiate radio frequency energy and can cause interference to radio communications and television and radio reception. See "Electromagnetic Interference" later in this chapter for recommended interference reduction measures.

## **Certifications**

Tests completed by MSA verify that the FiveStar Alarm meets applicable industry and government standards (as of date of manufacture), including those for Electromagnetic Interference.

## **Electromagnetic Interference**

This equipment has been type tested and found to comply with the limits for a Class A digital device, pursuant to Part 15 of the FCC Rules. These limits are designed to provide a reasonable degree of prevention against interference when the equipment is operated in a commercial environment. This equipment generates, uses, and can radiate radio frequency energy and, if not installed and used in accordance with the instruction manual, may cause

interference to radio communications. Operation of this equipment in a residential area is likely to cause interference in which case the user will be required to correct the interference at his own expense.

This equipment was tested and found to comply with the limits for a Class B digital device, pursuant to Part 15 of the FCC Rules. These limits are designed to provide a reasonable degree of prevention against harmful interference in a residential installation.

Alarm levels are set at the factory and meet the most commonly accepted standards; see Chapter 4 for details. Setpoints can be changed to meet specific conditions.

This equipment generates, uses, and can radiate radio frequency energy and, if not installed and used in accordance with the instructions, may cause interference to radio communications. However, there is no guarantee that interference will not occur in a particular installation. If this equipment does cause interference to radio or television reception, which can be determined by turning the equipment OFF and ON, the user is encouraged to try to correct the interference by one or more of the following measures:

- Reorient or relocate the receiving antenna.
- Increase the separation between the equipment and receiver.
- Connect the equipment into an outlet on a circuit different from that to which the receiver is connected.
- Consult the dealer or an experienced radio TV technician for help.

This digital apparatus does not exceed the Class A limits for radio noise emissions from digital apparatus set out in the Radio Interference Regulations of the CRTC.

## General Limitations

Combustible gases will burn or explode only when the fuel/air mixture is within certain proportions. The minimum concentration of a particular combustible gas in air which can be ignited is defined as the Lower Explosive Limit (LEL). In some references, the term Lower Flammability Limit (LFL) is used.

Combustible gas readings with an OVER alarm in the display indicate an amount of gas which may be above the Lower

Explosive Limit (LEL) or above 5% methane (CH<sub>4</sub>) by volume. In such cases the instrument's lockalarm feature activates, preventing ambiguous readings which could occur above these concentrations. (See Chapter 4 for limits.)

## Instruments with Pumps or Aspirator Assemblies

If using a FiveStar instrument with a sampling pump or aspirator bulb assembly, perform a blocked flow test before each day's use. When performing the test, the appropriate indication must occur when blocking the flow. If the indication does not occur, check the instrument flow system for leaks.

Once the leak condition is corrected, perform the blocked flow test again to verify proper operation before using the instrument. Refer to the applicable section in this instruction manual for additional information.

### WARNING

**Perform a blocked flow test before each day's use. Failure to perform a blocked flow test can result in the user being unaware of the presence of gas.**

**Do not use the instrument unless the blocked flow indications occur when performing the blocked flow test. Lack of a blocked flow indication is a sign that a leak exists and the sample may not be drawn to the sensors, which could cause a false reading.**

**Failure to follow the above can result in serious personal injury or death.**

## Instruments with Pumps and Electronic Flow Indicators

With the pump running, block the sample line inlet or probe inlet.

- The blocked flow flag on the display must illuminate and an audible alarm must sound.

## Instruments with Aspirator Bulbs

With the aspirator bulb squeezed, block the sample inlet or probe inlet.

- The bulb must not inflate.

- Please note that some instruments with electronic flow indicators can have optional aspirator bulb accessories.
- The electronic flow indicators are not intended to activate when the aspirator is attached.

If there are questions regarding this information, please contact MSA Customer Service at:

**1-800-MSA-2222**

# Chapter 2

## Using the FiveStar Alarm

**It is your responsibility to know how to use the FiveStar Alarm.** When used properly, the FiveStar Alarm will alert you to the presence of combustible gases and vapors and to atmospheres that are rich or deficient in oxygen. It will also alert you to the presence of specific toxic gases if it is equipped with sensors for those gases. These conditions are displayed clearly and simultaneously on the face of the instrument.

Alarm levels are set at the factory and meet the most commonly accepted standards; see Chapter 2 of the FiveStar Alarm Technical Manual for details. Setpoints can be changed to meet specific conditions.

## Preparation

### Battery Pack Installation

When the battery pack is installed, the user has access to the following instrument options:

- Enable operating beep?
- Display Peak, STEL and TWA pages?
- Set time?
- Set date?

**NOTE:** For Australian approved instruments: to enter the setup mode described in this Chapter, the battery pack must be removed for 10 or more seconds.

1. To install the battery pack:
  - a. Slide it toward the sensor face of the instrument.

**NOTE:** See "Keying Series Red/Series Green Battery Packs" later in this Chapter.

- b. Swing battery pack down and into body of instrument.
- c. Turn the screw on the bottom of the instrument in a clockwise direction until firmly seated.

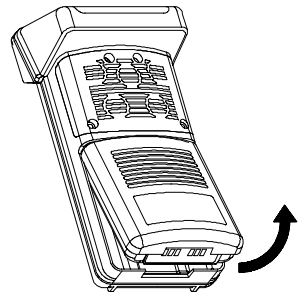
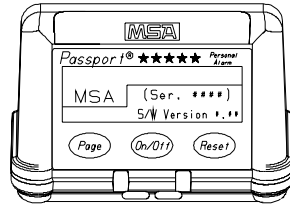

Figure 2-1.  
Battery Pack Installation

## 2. The instrument responds:

- backlight flashes
- screen flashes
- alarm sounds
- alarm lights flash
- instrument electronic serial number and software version display (FIGURE 2-2) appears.

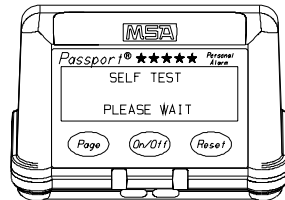

*Figure 2-2.  
Serial Number  
and Software Version*

After this screen, the instrument self-tests all major electronic components and the (FIGURE 2-3) display appears.

After tests are completed, if ERROR appears on the screen and the alarm sounds, refer to the Technical Manual for the FiveStar Alarm (P/N 710440).

When the electronics test passes, the unit inquires if the user wants to enter Setup Mode by displaying the (FIGURE 2-4) screen.



*Figure 2-3.  
Self Test*

If **PAGE** (NO) is pressed, or no buttons are pressed for five seconds, the unit assumes the user did not want to reset any options and unit turns ON.

If **RESET** (YES) is pressed, the instrument enters the Setup Mode.

If the Alternate Language Option is enabled, the (FIGURE 2-5) display appears.

If **PAGE** (SKIP) is pressed (or if no buttons are pressed for five seconds), the currently selected language remains the same.

If **RESET** (SET) is pressed the (FIGURE 2-6) display appears.

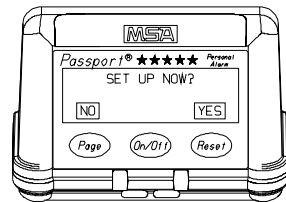

*Figure 2-4.  
Setup Now - No/Yes?*

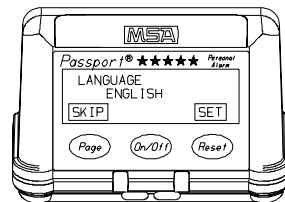

*Figure 2-5.  
Alternate Language Option*

- Press **PAGE** (UP arrows) or **RESET** (DOWN arrows) to scroll through the languages.
- Once the desired language displays, press **ON/OFF** (OK).
- If a new language is selected, the instrument prompts the user to choose to display the combustible gas readings as:
  - percent Lower Explosive Limit (LEL) Pentane OR
  - percent Methane.

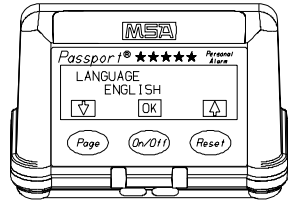

Figure 2-6.  
Scrolling through the Language Options

Pressing the **PAGE** (LEL) button causes the combustible readings to display as 0-100% LEL.

Pressing the **RESET** (YES) button causes the instrument to display combustible readings as direct 0-5% Methane.

- The (FIGURE 2-7) display appears.

If **PAGE** (NO) is pressed, or no buttons are pressed for five seconds, the operating beep will be disabled.

If **RESET** (YES) is pressed, the operating beep is enabled and the instrument alarm sounds once every 30 seconds to indicate that the FiveStar Alarm is turned ON. This beep does not occur if YES is not selected.

- The (FIGURE 2-8) display appears.

- If YES is selected, the PEAK STEL TWA pages appear.
- If NO is selected, the PEAK STEL TWA pages do *not* appear.
- If no button is pressed the unit maintains the previous setting for these pages.
- The display moves to the "Set Time" page.
- The (FIGURE 2-9) display now appears.

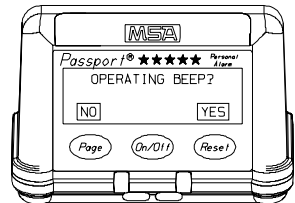

Figure 2-7.  
Operating Beep - No/Yes?

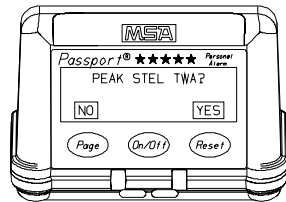

Figure 2-8.  
Peak STEL TWA?

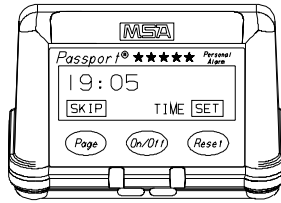

Figure 2-9.  
Time and Date Set

To cancel Time Set, press **PAGE** (SKIP) button or wait five seconds.

To set the time, press the **RESET** (YES) button.

- The (FIGURE 2-10) display appears.

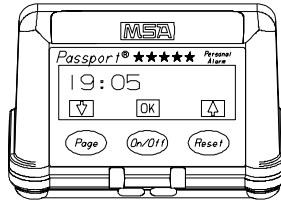

Figure 2-10.  
Time Set

- The hour flashes.
  - Press the **PAGE** button to lower the hours (19:05 is 7:05 P.M.).
  - Press **RESET** to raise the hours.
  - Press the **ON/OFF** button to accept the new number.
- The minutes now flash.
  - Adjust as needed.
  - Press the **ON/OFF** button to accept the reading.
- The (FIGURE 2-11) display appears.

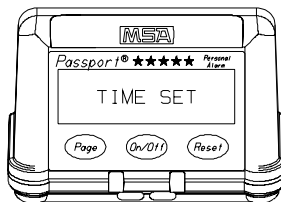

Figure 2-11.  
Time Set Complete

- The (FIGURE 2-12) display appears.

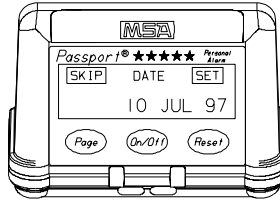

Figure 2-12.  
Date Set

To cancel the date set, press the **PAGE** (SKIP) button or wait five seconds.

To set the time, press the **RESET** (YES) button and the (FIGURE 2-13) display appears.

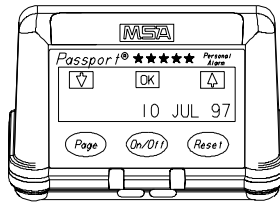

Figure 2-13.  
Day, Month, Year

- The Year is underlined.
  - Press the **PAGE** button to lower the year.
  - Press **RESET** to raise the year.
  - Press **ON/OFF** to accept the year setting and move on.
- The month is now underlined.
  - Press the **PAGE** button to lower the month.
  - Press **RESET** to raise the month.
  - Press **ON/OFF** to accept the month setting and move on.
- The day is now underlined.
  - Press the **PAGE** button to lower the day.
  - Press **RESET** to raise the day.
  - Press **ON/OFF** to accept the day setting and move on.

- When the selected date has been accepted, the (FIGURE 2-14) display appears.

**NOTE:** The instrument is equipped with a small battery to retain time settings when the battery pack is detached. If your instrument does not maintain the proper time consistently, return it to your nearest Service Center to have this battery replaced.

The instrument then prompts the user to determine if they want to view the instrument alarm setpoints.

- The (FIGURE 2-15) display appears.
- If **PAGE** (NO) is pressed (or if no button is pressed within five seconds), the setup is complete.
- If **RESET** (YES) is pressed, the instrument steps through the alarm screens [to view these screens, see the FiveStar Technical Manual (P/N 710440)].

Once alarm viewing is complete:

- The alarm sounds briefly
- The (FIGURE 2-16) display appears.
- The instrument now automatically turns ON and runs through the following procedure for normal instrument turn-on.

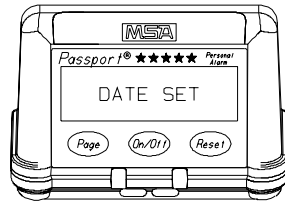

Figure 2-14.  
Date Set Complete

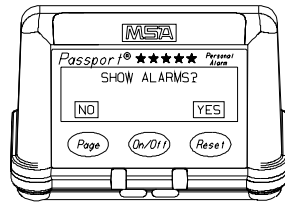

Figure 2-15.  
Show Alarms?

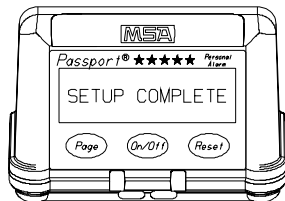

Figure 2-16.  
Setup Complete

## Turning ON the FiveStar Alarm

Push the **ON/OFF** button.

- The backlight flashes
- The screen flashes
- The alarm sounds
- The alarm lights flash.

The instrument steps through two screens, showing the units and gases installed respectively as shown in (FIGURE 2-17) and (FIGURE 2-18).

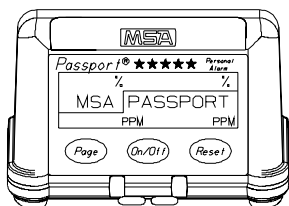

Figure 2-17.  
Units Measured

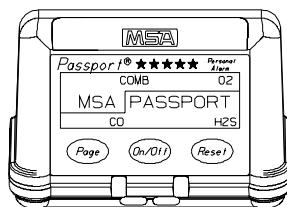

Figure 2-18.  
Gases Measured

If the "Display Alarms" option is enabled, the user is prompted to decide if they want to view the alarms (FIGURE 2-15).

If the Fresh Air Setup (FAS) feature is enabled, the combustible and toxic sensors can be zeroed, and the oxygen sensor can be spanned to 20.8%. FAS must only be used in fresh air. (See "Fresh Air Setup Option" later in this Chapter for additional information.)

## Fresh Air Set Up Option

(for automatic zero adjustment of the FiveStar Alarm sensors)

**NOTE:** The Fresh Air setup has limits. If a hazardous level of gas is present, the FiveStar Alarm ignores the FAS command and goes into alarm.

### WARNING

Do not activate the fresh air setup unless you are certain you are in fresh, uncontaminated air; otherwise, inaccurate readings can occur which can falsely indicate that a hazardous atmosphere is safe. If you have any doubts as to the quality of the surrounding air, do not use the fresh air setup feature. Do not use the fresh air setup as a substitute for daily calibration checks. The calibration check is required to verify span accuracy. Failure to follow this warning can result in serious personal injury or death.

Persons responsible for the use of the FiveStar Alarm must determine whether or not the Fresh Air Setup option should be used. The user's abilities, training and normal work practices must be considered when making this decision.

- When the (FIGURE 2-19) display appears, the FiveStar Alarm is ready for its Fresh Air Set Up.

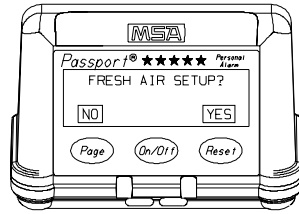

Figure 2-19.  
Fresh Air Set-up

### To Proceed With Fresh Air Setup:

1. Press the **RESET (YES)** button; the display reads:

#### ADJUSTING ZEROES PLEASE WAIT

- a. When the (FIGURE 2-20) display appears:

- Alarm sounds
- Lights flash

- 1) Push the **RESET (OK)** button.
- 2) Make certain the FiveStar Alarm is in fresh air; move to another location, if necessary. Allow the FiveStar Alarm to warm up for a few minutes to allow the sensors to stabilize.

Turn FiveStar Alarm OFF and then back ON again.

- 3) If the FiveStar Alarm cancels the Fresh air Setup request again, calibration adjustments may be required. Report to the person responsible for FiveStar Alarm maintenance.

Do not use the instrument for protection.

- b. When the Fresh Air Setup is completed:

- Instrument enters the Exposure display page, displays gas readings, and is ready for use.

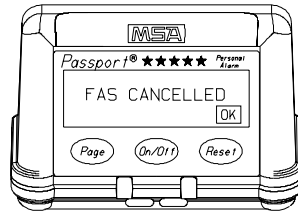

Figure 2-20.  
FAS Canceled/OK

### To Bypass The Fresh Air Set Up:

Press the **PAGE (NO)** button, or wait five seconds.

- Display enters Exposure page.
- Display begins to show gas readings.
- The instrument is ready for use.

If the sensors drift off of zero a few minutes after being turned ON, move to fresh air; then, try the Fresh Air Setup again.

## Using the FiveStar Alarm

The FiveStar Alarm has three standard and three optional display pages. You can move sequentially from one to the next by pressing the **PAGE** button. You can return to the standard Exposure display page by waiting for 15 seconds or by pressing the **ON/OFF** button from another page.

The three standard display pages are:

- Exposure display
- Battery condition
- Time and date.

The three optional display pages are:

- Peak readings
- Short Term Exposure Limit (STEL)
- Time Weighted Average (TWA).

If any one of these optional display pages is enabled, it will appear on your instrument in the order shown above.

**NOTE:** The FiveStar Alarm measures concentrations of gases no matter what display page is shown. When an alarm condition is reached, the alarm sounds automatically. The measurements made by the FiveStar Alarm are NOT dependent upon a specific display page being shown.

### Exposure Display

In this normal display page, numbers appear near the gas labels on the instrument's display panel (FIGURE 2-21).

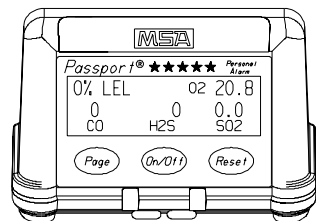

Figure 2-21.  
Exposure Page

To see the gas units (FIGURE 2-22) press the **ON/OFF** button.

To change from the Exposure display to the Battery Condition page, press the **PAGE** button.

## Battery Condition

The FiveStar Alarm displays battery condition in one of two ways, depending on type of battery pack installed.

- **Rechargeable NiCad Battery Pack** - The following information is displayed(FIGURE 2-23):
  - Battery pack type
  - Estimated remaining run time
  - Bargraph and number indicating the percentage of remaining charge.
- **Replaceable Battery Pack** - The following information is displayed (FIGURE 2-24):
  - Battery pack type
  - Battery charge voltage
  - Battery voltage status (OK or LOW).

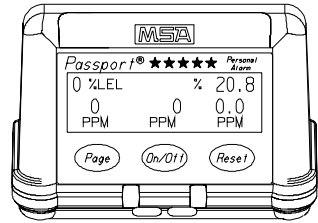

Figure 2-22.  
Gas Units

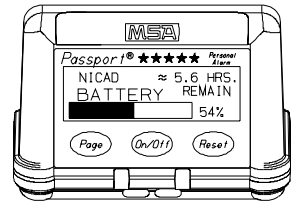

Figure 2-23.  
Battery Condition

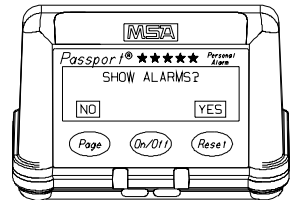

Figure 2-24.  
Replaceable Battery Page

### ***Battery Conditions that can be displayed on the Battery Display Page:***

- **OK:** enough voltage to function properly
- **LOW:**
  - **BATT** appears in the Exposure Display Page
  - Horn sounds (Press the **RESET** button to silence it.)
  - After initial **LOW** warning, the horn sounds approximately every five minutes
  - The battery will operate the FiveStar Alarm for approximately 10 more minutes provided the **RESET** button is pressed after each warning.

- The instrument will continue to operate until the power is turned OFF or the battery condition is at **BATTERY SHUTDOWN** level.

Approximate Voltage Readings for Replaceable Battery Pack Alarms	
WARNING	3.3 VOLTS
SHUT-DOWNS	3.1 VOLTS

- **BATTERY SHUTDOWN:** the battery is no longer able to operate the instrument, and:
  - **BATTERY SHUTDOWN** appears in place of the Exposure Display Page. Horn sounds continuously and cannot be reset.
  - Alarm lights flash and the horn sounds intermittently.
  - No other pages can be viewed.
  - After approximately five minutes, the instrument shuts down automatically.

**⚠ WARNING**

When the Battery Shutdown condition sounds, stop using the instrument. It cannot alert you of potential hazards because it does not have enough power to operate properly. You must:

1. Leave the area immediately.
2. Turn OFF the instrument if it is ON.
3. Report to the person responsible for maintenance. Replace or recharge the battery pack.

If you do not follow this procedure, you could be injured or killed.

**⚠ WARNING**

For Replaceable Battery packs, replace batteries when the "Battery Low" or "Battery Shutdown" alarms occur. When replacing lithium or alkaline batteries, replace ALL batteries with fresh ones at the same time. Do not mix battery types or new and partially-discharged batteries. If the batteries are improperly replaced or improperly mixed, the "Battery Low" and "Battery Shutdown" alarms may fail to function, which could result in serious personal injury or death.

## ⚠ WARNING

Do not use rechargeable nickel cadmium batteries in Replaceable Battery Packs. The Replaceable battery warning and alarm setpoints are not optimized for nickel cadmium batteries. The low battery warning and alarm could occur too quickly to be noticed. If you do use nickel cadmium batteries in the Replaceable battery pack you could be injured or killed.

**NOTE:** The FiveStar unit recognizes the type of battery pack (rechargeable nickel cadmium or replaceable alkaline) is attached and automatically adjusts the low battery warning and alarm setpoints.

## ⚠ CAUTION

During "Battery Low" condition, prepare to exit the work area as the instrument could go into "Battery Shutdown" at any time, resulting in loss of sensor function. Depending on the age of the batteries, ambient temperature and other conditions, the FiveStar Alarm "Battery Low" and "Battery Shutdown" times could be shorter than anticipated.

## ⚠ WARNING

Recharge or replace the batteries when the "Battery Low" or "Battery Shutdown" conditions occur.

Do not reuse a Ni-cad battery without recharging, even if the battery regains some charge after a period of non-use.

When replacing Lithium or Alkaline batteries, replace ALL batteries with fresh ones. Do not mix battery types or mix new and partially-discharged batteries.

If batteries are not recharged or replaced or, if they are mixed improperly, the "Battery Low" or "Battery Shutdown" alarms may fail to function, which could result in serious personal injury or death.

## Time Display

Press the **PAGE** button

In the third standard display page, the time and date are displayed. The time is displayed in a 24-hour format. For example, "June 18

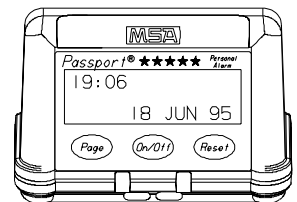

Figure 2-25.  
Time Display

1995" would read as shown (FIGURE 2-25) at 7:06 p.m.

## Measuring Gas Concentrations

### Combustible Gases (COMB)

The FiveStar Alarm detects combustible gases in the atmosphere. The Alarms sound when concentrations reach:

- Alarm setpoint, or
- 100% LEL (Lower Explosive Limit), or
- 5% CH<sub>4</sub> (Methane by volume)

When the combustible gas indication reaches the Alarm Setpoint:

- Alarm sounds
- Alarm lights flash
  - Press the **RESET** button to silence the alarm. (The alarm will stay silent if the alarm condition has cleared.)
- Concentration of gas flashes in the display (FIGURE 2-26).

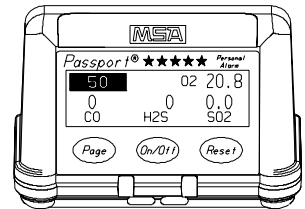

Figure 2-26.  
Combustible Gas Alarm Flag

When the combustible gas indication reaches 100% LEL or 5% CH<sub>4</sub> of the combustible gas:

- Alarm sounds
- Alarm lights flash
  - This alarm cannot be reset with the **RESET** button.

The LockAlarm™ circuit locks the combustible gas reading and alarm if the gas reading exceeds 100% LEL or 5% methane.

- **OVER** appears on the display.

### **⚠ WARNING**

If the **OVER** alarm condition is reached, you may be in a life-threatening situation; there may be enough gas in the atmosphere for an explosion to occur. In addition, any rapid up-scale reading followed by a declining or erratic reading can also be an indication that there is enough gas for an explosion. If either of these indications occur, leave and move away from

**the contaminated area immediately. Failure to follow this warning can result in serious personal injury or death.**

After moving to a safe, fresh-air environment, the alarm can be reset by turning OFF the instrument and turning it ON again.

## Oxygen Measurements

The FiveStar Alarm detects the amount of oxygen in the atmosphere. There are two conditions which trigger the alarm:

- Too little oxygen (deficient)
- Too much oxygen (enriched)

At the Alarm Setpoint for either:

- Alarm sounds
- Alarm light flashes
- Concentration of gas flashes in the display (FIGURE 2-27).

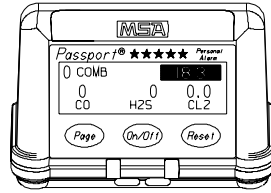

Figure 2-27.  
Oxygen Alarm Flag

### **⚠ WARNING**

If the OXYGEN alarm condition is reached while using the instrument as a personal or area monitor, leave the area immediately; the ambient condition has reached a preset alarm level. If using the instrument as an inspection device, do not enter the area without proper protection. Failure to follow this warning will cause exposure to a hazardous environment which can result in serious personal injury or death.

## Toxic Gas Measurement

The FiveStar Alarm detects certain toxic gases in the atmosphere. Your instrument may have up to three toxic sensors. Each of these sensors has a setpoint which causes an alarm if the gas level goes above that setpoint. When this happens:

- Alarm sounds
- Alarm lights flash
- Concentration of gas flashes in the display.

## ⚠ WARNING

If the TOXIC GAS alarm condition is reached while using the instrument as a personal or area monitor, leave contaminated area immediately; the ambient gas concentration has reached a preset alarm level. If using the instrument as an inspection device, do not enter area without proper protection. Failure to follow this warning will cause over-exposure to toxic gases which can result in serious personal injury or death.

## Calibration Check

This calibration check is very simple and should only take one to five minutes, depending on the number and type of gases your FiveStar Alarm is equipped to sense. Turn the FiveStar Passport FiveStar Alarm ON in clean fresh air, and verify that the readings indicate no gas present.

1. Attach calibration cap to the FiveStar Alarm, orienting the inlet fitting to point toward the battery pack:
2. Attach the calibration adapter to the calibration cap.
3. Attach the regulator (supplied with the calibration kit) to the cylinder.
4. Connect the black tubing supplied with the calibration kit to the regulator.
5. Open the valve on the regulator, and connect the other end of the tubing to the inlet fitting.

The flow rate of the regulator is 0.25 lpm. Note the readings on the FiveStar display; they should be within the limits stated on the calibration cylinder or limits determined by your company. (If necessary, change

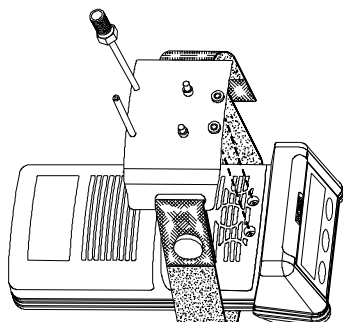

*Figure 2-28.  
Metal Calibration Cap Installation  
(Early Versions Only)*

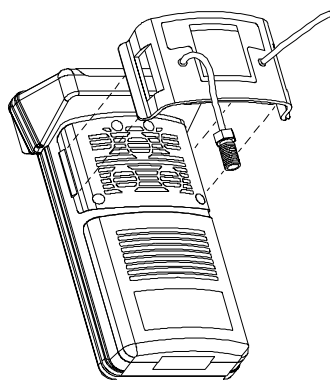

*Figure 2-29.  
Snap Calibration Cap Installation*

cylinders to introduce other calibration gases.)

If the readings are not within these limits, the FiveStar Alarm requires recalibration. See "Autocalibration" later in this Chapter or, if autocalibration is not enabled, see the FiveStar Technical Manual (P/N 710440), Chapter 2, for detailed manual calibration instructions.

## Options

### Optional Displays

**NOTE:** The following display pages appear only if enabled; see the FiveStar Alarm Technical Manual for instructions.

Press the **PAGE** button to move to:

### Peak Readings

This shows the highest levels of gas that the FiveStar Alarm recorded since it was turned ON or since the peak readings were reset (FIGURE 2-30).

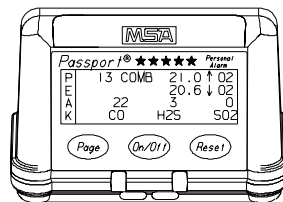

Figure 2-30.  
Peak Readings

### To reset the Peak Readings:

1. In Peak display, press the **RESET** button.
  - The (FIGURE 2-31) display appears.
2. Press the **RESET (YES)** button to reset peak readings or press the **PAGE (NO)** button or wait 15 seconds to cancel.

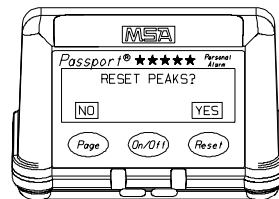

Figure 2-31.  
Reset Peak Readings

Press the **PAGE** button to move to the (FIGURE 2-32) display.

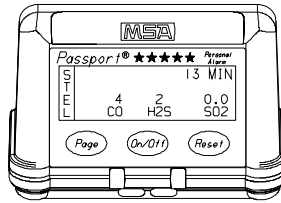

Figure 2-32.  
STEL Page

## Short Term Exposure Limit (STEL)

This shows the average exposure over a 15 minute period.

When the amount of gas detected by the FiveStar Alarm is greater than the STEL limit:

- On the Exposure display page, the (FIGURE 2-33) display appears.

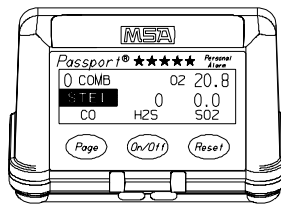

Figure 2-33.  
STEL Alarm Flag

- Alarm sounds
- Alarm lights flash
- This STEL alarm display alternates with the exposure reading on the exposure page.

To reset the alarm:

- Press the **PAGE** button four times to access the PEAK page
- In the STEL display, press the **RESET** button once and the Acknowledge Reset STEL page appears.
- Press the **RESET** button a second time to acknowledge.

## ⚠ WARNING

If the STEL alarm condition is reached while using the instrument as a personal or area monitor, leave contaminated area immediately; the ambient gas concentration has reached the preset STEL alarm level. Failure to follow this warning will cause over-exposure to toxic gases which can result in serious personal injury or death.

The STEL alarm is calculated over a 15-minute exposure. Calculation examples are as follows.

**Assume the FiveStar Alarm has been running for at least 15 minutes.**

- 15-minute exposure of 35 PPM:

$$\frac{(15 \text{ minutes} \times 35 \text{ PPM})}{15 \text{ minutes}} = 35 \text{ PPM}$$

- 10-minute exposure of 35 PPM
- 5-minute exposure of 5 PPM:

$$\frac{(10 \text{ minutes} \times 35 \text{ PPM}) + (5 \text{ minutes} \times 5 \text{ PPM})}{15 \text{ minutes}} = 25 \text{ PPM}$$

**Assume the FiveStar Alarm was turned on five minutes ago.**

- 5-minute exposure of 15 PPM:

$$\frac{(5 \text{ minutes} \times 15 \text{ PPM}) + (10 \text{ minutes} \times 0 \text{ PPM})}{15 \text{ minutes}} = 5 \text{ PPM}$$

Press the **PAGE** button to move to:

## Time Weighted Average (TWA)

TWA is the average exposure since the TWA reading was reset. The TWA reading may be reset using the following procedure:

- Turn the FiveStar Alarm OFF for eight or more hours or
- Press the **PAGE** button until the TWA screen appears
  - Press the **RESET** button; the "Reset TWA" message appears on the display.
  - Press the **RESET (YES)** button.

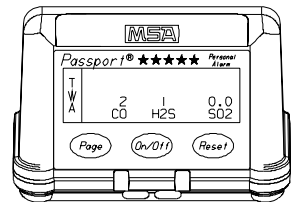

Figure 2-34.  
Reset TWA Page

When the amount of gas detected by the FiveStar Alarm is greater than the eight-hour TWA limit:

- Alarm sounds
- Alarm lights flash
- On the Exposure display page, the TWA alarm flag displays.

### **⚠ WARNING**

**If the TWA alarm condition is reached while using the instrument as a personal or area monitor, leave contaminated area immediately; the ambient gas concentration has reached the preset TWA alarm level. Failure to follow this warning will cause over-exposure to toxic gases which can result in serious personal injury or death.**

The TWA alarm is calculated over an eight-hour exposure. Calculation examples are as follows:

- 1-hour exposure of 50 PPM:

$$\frac{(1 \text{ hour} \times 50 \text{ PPM}) + (7 \text{ hours} \times 0 \text{ PPM})}{8 \text{ hours}} = 6.25 \text{ PPM}$$

- 4-hour exposure of 50 PPM  
4-hour exposure of 100 PPM:

$$\frac{(4 \text{ hours} \times 50 \text{ PPM}) + (4 \text{ hours} \times 100 \text{ PPM})}{8 \text{ hours}} = 75 \text{ PPM}$$

- 12-hour exposure of 100 PPM:

$$\frac{(12 \text{ hours} \times 100 \text{ PPM})}{8 \text{ hours}} = 150 \text{ PPM}$$

**NOTE:** The accumulated reading is always divided by eight hours.

To reset the alarm: in the TWA display, press the **RESET** button.

## Datatagging Option

Datatagging allows the user to save an alphanumeric designation in the instrument's session datalog. This data tag is saved with a time stamp so it can then be related to the gas readings at that time. This provides the user with an instrument location record coupled with a date and time.

## Setting a Tag

1. Press the **PAGE** button until the (FIGURE 2-35) screen appears:
2. Press the **RESET (YES)** button.
  - A screen showing the last saved data tag appears (FIGURE 2-36).
3. Press **OK** to accept the alphanumeric tag or press **EDIT** to change the tag.
  - If no button is pressed within 10 seconds, this data tag is automatically stored.
  - The display returns to the Measure Gases Page.
  - a. If you press **EDIT**, a screen similar to (FIGURE 2-37) appears.
  - b. Press **PAGE** or **RESET** (up or down arrows) to edit the first character.
  - c. Press **ON/OFF (NEXT)** to proceed to the next character in the tag.
  - d. Repeat Steps (b) and (c).
    - Tag is automatically recorded when last character is entered.
    - The (FIGURE 2-38) screen appears:

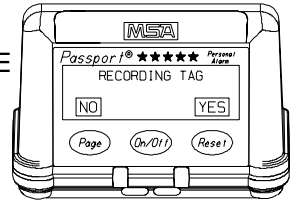

Figure 2-35.  
Setting Tag Page

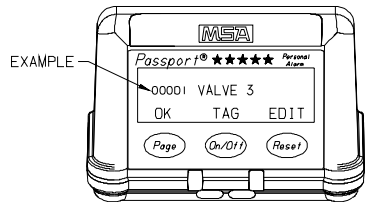

Figure 2-36.  
Last Data Tag Page

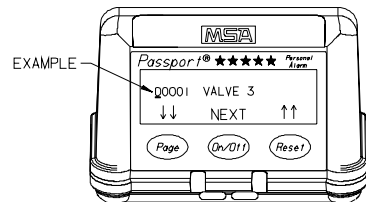

Figure 2-37.  
Editing Tag Page

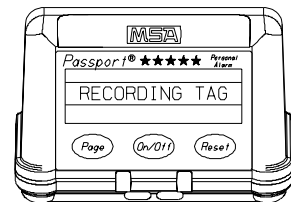

Figure 2-38.  
Recording Tag Page

## Autocalibration

The Autocalibration sequence resets the instrument zeroes and adjusts the sensor calibration for known concentration of calibration gases. Autocalibration is standard on FiveStar Alarms when factory-shipped with any combination of the following sensors:

AUTOCALIBRATION ALLOWABLE SENSORS	EXPECTED GAS CONCENTRATION	THREE-GAS CYLINDER (MSA P/N 10010162)	FOUR-GAS CYLINDER (MSA P/N 804770 OR P/N 711058)
COMBUSTIBLE	58%	✓	✓
OXYGEN	15%	✓	✓
CARBON MONOXIDE	300 PPM	✓	✓
HYDROGEN SULFIDE	10 PPM		✓

If any other sensors are installed in the instrument, the feature is automatically disabled. The Autocalibration feature can also be disabled by using the MSA FiveStar LINK™.

- To access Autocalibration, press and hold the **RESET** button for three seconds.
  - (FIGURE 2-39) display appears.
- Press the **RESET (YES)** button to start the Autocalibration sequence.

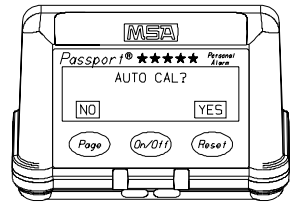

Figure 2-39. Auto Cal? YES/NO

- The instrument display indicates that it is adjusting zeroes.
- NOTE:** During the Autocalibration zero procedure, the limits on the zero adjustments present during the Fresh Air Setup option are eliminated.

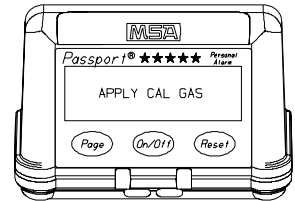

Figure 2-40. Apply Cal Gas

**NOTE:** For autocalibration, all gases must be in one cylinder. See TABLE 2-1 for allowable cylinders and concentrations.

- After zeroes are adjusted, the instrument prompts the user to apply calibration gas (FIGURE 2-40) and to cycle through the gas readings (FIGURE 2-41) one-at-a-time for 90 seconds.
- If the Autocalibration sequence has passed, the instrument briefly displays a screen reminding the user to remove the calibration gas

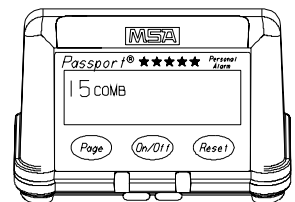

Figure 2-41. Example of a Combustible Gas Reading

or the calibration cap (if a pump was not used).

- The instrument then automatically returns to the Measure Gas mode.

**NOTE:** The autocalibration procedure adjusts the span value for any sensors which pass the test. Sensors that fail autocalibration are left unchanged.

**NOTE:** Since residual gas may be present, the instrument may briefly go into an exposure alarm after the calibration sequence is completed.

- If Autocalibration span sequence fails, the (FIGURE 2-42) display appears.
- To view which sensor(s) failed, press **ON/OFF** (SHOW) button.
- Instrument displays the expected gas values (FIGURE 2-43) and displays if sensor reading (FIGURE 2-44) was:
  - OK
  - LOW or
  - HIGH.

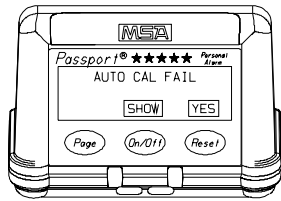

Figure 2-42.  
Auto Cal Fail Show/OK

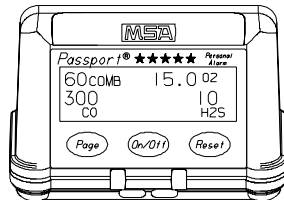

Figure 2-43.  
Example of  
Expected Gas Values

If a sensor fails the calibration, this does not necessarily indicate that the sensor is no longer functional. In order to ensure that proper calibration gases were used (TABLE 2-1), the Autocalibration only adjusts sensors that were initially within 30% of the expected values. If the sensor fails Autocalibration, the calibration sequence given in the FiveStar Technical Manual (P/N 710440), Chapter 2, may be used to manually adjust the sensor to within specifications.

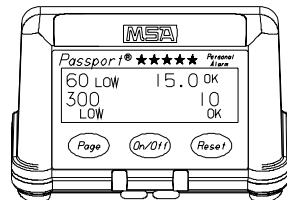

Figure 2-44.  
Example of Expected Values  
with OK/LOW/HIGH

## Turning OFF the FiveStar Alarm

Push and hold the **ON/OFF** button for three seconds.

- The (FIGURE 2-45) countdown appears.

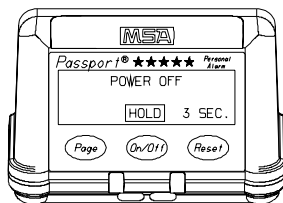

Figure 2-45.  
Power Down

## Battery Pack Removal

1. Turn the power OFF by pressing and holding the **ON/OFF** button for five seconds.
  - **POWER OFF** appears on the display.

### **CAUTION**

**Do not remove battery pack while instrument is still ON. Failure to turn instrument OFF prior to removing the battery pack could damage the instrument.**

2. Turn the battery mounting screw on the back of the instrument in a counterclockwise direction until the screw turns freely.
3. Pull out the battery pack by gripping it at the edge of the battery pack case and pulling it away from the unit.

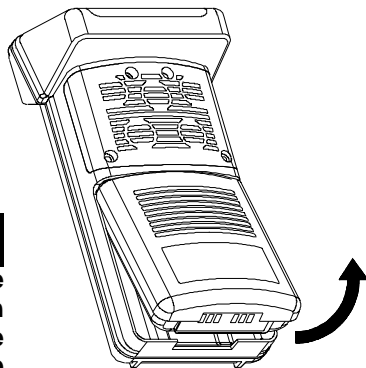

Figure 2-46.  
Battery Pack Removal

## Optional Sampling Equipment

Sampling lines and related equipment permit samples of gas to be taken from remote or inaccessible locations.

Sampling lines are five to 50 feet long and are made of a synthetic material specifically compounded to resist absorption of combustible and toxic vapors. Gases are drawn through the lines to the FiveStar Alarm by a pump.

Using the shortest possible line reduces the time the pump must run before valid samples and readings can be obtained.

## PulseCheck™ Pump Module

Through simple attachment, the PulseCheck Pump Module allows you to change from diffusion operation to pumped operation.

The pump may be attached temporarily (for remote sampling) or permanently, depending on your requirements.

- Prior to pump attachment, verify FiveStar battery contacts are clean and unobstructed.
- Inside the Pump Module and below the battery contacts, are two raised plastic tabs which mate with two notches on the FiveStar unit bottom, near the battery pack hold-down screw. Battery and Pump Module contacts must meet to ensure proper operation.

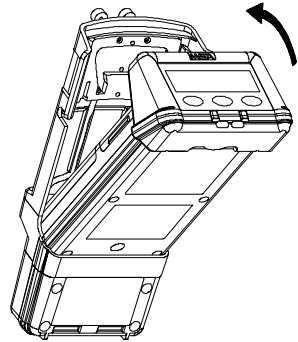

Figure 2-47.  
PulseCheck Pump Module

### Temporary Pump Installation

1. Remove thumbscrews from pump module and store for possible future use.
2. Bring the Pump Module toward the back of the instrument at about a 45 degree angle.
3. Engage the tabs on the bottom of the pump with the slots in the case.
4. Rock the pump housing down and snap the two sides of the pump over the tabs on the sensor cover.

### Permanent Pump Installation

To install the pump permanently on the FiveStar Alarm

1. Remove the two screws in the sensor cover nearest the display head.
2. Bring the pump module toward the back of the instrument at about a 45 degree angle.
3. Engage the tabs on the bottom of the pump with the slots in the case.
4. Rock the pump housing down and snap the two sides of the pump over the tabs on the sensor cover.
5. Finger-tighten thumbscrews into instrument.

- Do not over-tighten the screws as damage can occur.

## Turn ON Instrument and Verify Proper Operation

1. Turn ON the FiveStar Unit.
  - The pump motor will start fast, then slow down as the instrument adjusts the power to run the pump.
2. Once the gas readings are displayed, plug the free end of the sampling line or probe. The pump motor shuts down and an alarm sounds. (The readings on the display may change.)

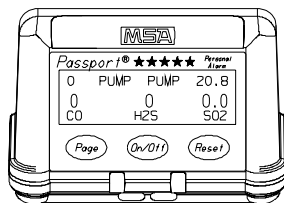

Figure 2-48.  
Pump Alarm

When the pump inlet/sample line/probe is blocked, the pump alarm must activate. If the alarm does not activate, check the pump/sample line/probe for leaks; once the leak is fixed, recheck the pump alarm by blocking the flow. Check the pump before each day's use.

When the pump inlet/sample line/probe is blocked, the pump alarm must activate. If the alarm does not activate, check the pump/sample line/probe for leaks; once the leak is fixed, recheck the pump alarm by blocking the flow. Check the pump before each day's use.

### **⚠ WARNING**

**Do not use the pump/sample line/probe unless the pump alarm activates when the flow is blocked. Lack of an alarm is an indication that a sample may not be drawn to the sensors, which could cause inaccurate readings. Failure to follow the above can result in serious personal injury or death.**

3. Press the **RESET** button to reset the alarm and restart the pump. During operation a pump alarm may occur when the:
  - pump is attached or removed
  - flow system is blocked
  - pump unit is inoperative
  - sample lines are attached or removed.

To clear the alarm:

- Correct the flow blockage (if necessary)
- Press the **RESET** button.

The pump will now restart.

**NOTE:** When the instrument is in a gas alarm, the pump alarm may not display until after the gas alarm is cleared.

### **⚠ CAUTION**

Never let the end of the sampling line touch or go under any liquid surface. If liquid is sucked into the instrument, readings will be inaccurate and the instrument could be damaged. We recommend the use of an MSA Sample Probe (part no. 497600, 800332, 800333, or equivalent) containing a special membrane filter, permeable to gas but impermeable to water, to prevent such an occurrence.

## **FiveStar Alarm Aspirator Assembly**

The FiveStar Alarm Aspirator Assembly is an accessory for use with FiveStar Alarms. Through simple attachment, it allows you to change from diffusion operation to pumped operation.

- Prior to Aspirator Assembly attachment, verify FiveStar battery contacts are clean and unobstructed.
- Inside the Aspirator Assembly, below the battery contacts, are two raised plastic tabs which mate with two notches on the FiveStar unit bottom, near the battery pack hold-down screw. Battery and Aspirator Assembly contacts must meet to ensure proper operation.

### **⚠ WARNING**

Once the Aspirator Assembly is no longer being used for sampling, remove it and allow the Passport unit to sample in the diffusion mode. Otherwise, if the Aspirator Assembly is in place and the aspirator bulb is not actively being used, atmospheric samples will not reach the sensors; inaccurate readings may occur, which may cause serious personal injury or death.

Use this Aspirator Assembly to sample only the following gases. Using the Aspirator Assembly to sample other gases may result in inaccurate readings which may cause serious personal injury or death.

Methane	Hydrogen	Oxygen
Propane	Butane	Carbon Monoxide
Pentane	Ethane	Hydrogen Sulfide

**⚠ WARNING**

**Certain gases may react with the Aspirator Assembly; this may cause lower than actual readings. If these gases are suspected, re-verify readings in the diffusion mode by removing the Aspirator Assembly or by using Pump Module (P/N 710790).**

**Attaching the Aspirator Assembly**

1. Remove the two sensor lid screws located closest to the display face.
  - Store screws inside the Aspirator Assembly, on the white manifold containing two recesses on each edge to securely hold the screws.
2. Once screws are removed, align the Aspirator Assembly tabs to sit inside the main body recesses by tilting the Aspirator Assembly gently onto the back of the FiveStar unit.
  - Ensure tabs engage notches; do not force connection as damage can occur.
3. Gently rotate the Aspirator Assembly until the manifold contacts the FiveStar unit sensor cover.
  - Thumb screws align with holes left by the screws removed in step 1.
4. Finger-tighten the screws to secure the Aspirator Assembly to the FiveStar unit.
  - Do not use tools or force the screws as damage can occur.
5. Attach sample lines (up to 25 feet long) and attach the probe.

**Operation and Use**

1. Block sample line or probe inlet and squeeze the aspirator bulb.
  - With long sample line lengths (up to 25 feet), the bulb may slowly inflate as a vacuum is drawn in the sample line; squeeze the bulb one more time if necessary.
  - The bulb should now remain deflated; if bulb inflates, check for leaks and tighten as necessary.
2. Place the end of the probe at the point the sample is to be taken.
3. Squeeze the bulb 10 times, allowing it to fully inflate between squeezes.
  - Note the readings.

**NOTE:** Due to pulsations introduced by the Aspirator Bulb Assembly, instability of readings may occur. Before noting the readings, allow readings to stabilize for three or four seconds after the bulb is squeezed.

### ⚠ CAUTION

Do not permit the end of the sampling line to touch or go under any liquid surface. If liquid is sucked into the instrument, readings will be inaccurate and the instrument could be damaged. To prevent this, use Sample Probe (P/N 497600 or 800333) or an equivalent containing a special membrane filter, permeable to gas but not to water.

## Attaching Probe to Sampling Line

(FIGURE 2-49)

- Grasp the probe handle by the top two sections:
  - the large section (cap) with the MSA logo and
  - the center section (base) with the label.
- Unscrew lower section (guard) from the label section.
- Feed male end of the sample line through the guard and screw into the exposed connector ring on the probe.
- Screw the guard back onto the base.

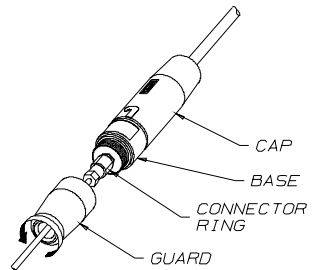

Figure 2-49.  
Attaching Probe to Sample Line

## Changing the Probe Filter

(FIGURE 2-50)

- Grasp the probe handle by the base and guard.
- Push the cap section toward the other two and turn clockwise (the spring will push the sections apart).
- Grasp and spin the wand clockwise while pulling to disengage.

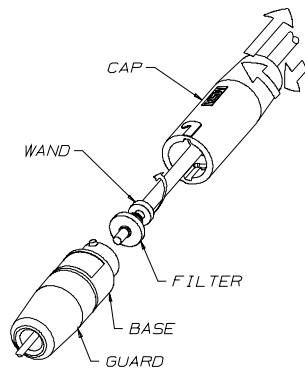

Figure 2-50.  
Changing the Probe Filter

4. Remove the water trap filter and replace.

## Removing Sampling Equipment

1. Turn OFF the FiveStar Alarm.
2. Unscrew the connector ring on the sampling line; remove sampling line.

## Keying Series Red/Series Green Battery Packs

Instruments built after February, 1999 are designed to accept keyed battery packs conforming to:

- North American standards (marked "SERIES GREEN") or to
- European/Australian standards (marked "SERIES RED").

Always match the battery pack to the corresponding instrument by noting these SERIES GREEN and SERIES RED labels.

- Instruments built prior to February, 1999 conform to the North American standards and should only be used with SERIES GREEN battery packs.

### ⚠ CAUTION

**SERIES RED and SERIES GREEN battery packs are not interchangeable; damage may occur to the instrument and/or battery pack if the SERIES RED and SERIES GREEN battery packs are interchanged.**

- To use a new SERIES GREEN battery pack with a North American standard instrument built before February, 1999:
  1. To verify that the instrument was built to conform with North American standards, ensure that it has an approval label listing MET and/or MSHA.
  2. Remove the key in the battery pack (FIGURE 2-51) by prying it out of

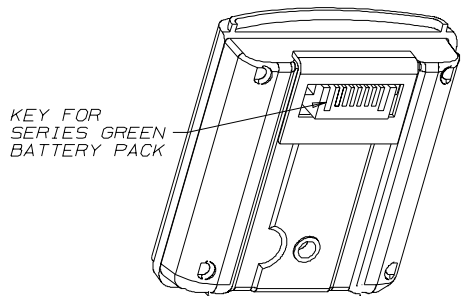

Figure 2-51.

Key for SERIES GREEN Battery Pack

the connector slot with a small, sharp object (e.g., thumbtack).

- Never use a battery pack built prior to February 1999 with an instrument built to conform with European or Australian standards.

## Recharging Ni-Cad and NiMH Battery Packs

The FiveStar Ni-Cad rechargeable battery packs are charged using the MSA Omega<sup>®</sup> battery charging system or the MSA FiveStar Fast Charger.

The FiveStar Alarm NiCd and NiMH battery packs must be recharged using the MSA Universal Fast Charger (P/N 10065552) [Kit (P/N 10065553) or (P/N 10065556)].

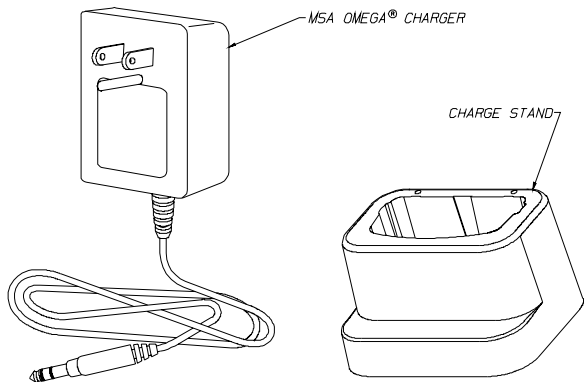

Figure 2-52.  
Ni-Cad Charger (120V version shown)

Use of any other chargers for NiCd or NiMH battery packs may damage the batteries.

The FiveStar unit should be turned OFF or the battery pack should be removed from the FiveStar unit during charging. Be certain that the charger is properly connected by checking to see that the charger's LED is lit.

The Fast Charger completes the fast charge cycle in less than five hours after which the Charger switches to a topping charge mode. After fast charge, the batteries will be more than 90% full.

Recharge Times		
<b>OMEGA CHARGER (NiCd Only)</b>	16 hours	
<b>FAST CHARGER</b>	WITHOUT TOPPING	5 hours
	WITH TOPPING	7 hours

The battery pack may be charged when it is connected to the FiveStar Alarm or when it is removed. If the battery pack is connected to the FiveStar Alarm:

1. Turn OFF the instrument and insert it into the charge stand.
2. Insert the charger plug into the jack on the charge stand.
3. Plug the charger into a matching receptacle.
  - The red light on the Omega Charger lights if the charger is properly connected.
  - The charge mode indicator light on the Fast Charger turns red.

## Replaceable Battery Pack Instructions

The FiveStar Alarm Replaceable Battery pack can be used as a full-time battery pack or as a backup power source for all Australian approved instruments and North American approved instruments with hardware version "D1" or higher.

**NOTE:** To view the Hardware version, remove the instrument battery pack. The Hardware/Software version is the first two characters of the instrument serial number located on the instrument under the battery.

The North American approved Replaceable Battery Pack is provided with Energizer L91 AA lithium batteries.

- For the greatest run time or full-shift FiveStar Alarm operation, it is recommended that you use these lithium batteries as replacements.
- The Australian approved replaceable battery pack is provided with Duracell MN1500 alkaline batteries. These are also approved to operate the North American approved instrument.

### To Replace the Batteries

1. Remove the battery pack from the instrument by loosening the screw on the bottom-side of the instrument.
2. Turn the battery pack over and loosen the 1/4-turn fastener on the bottom of the pack.

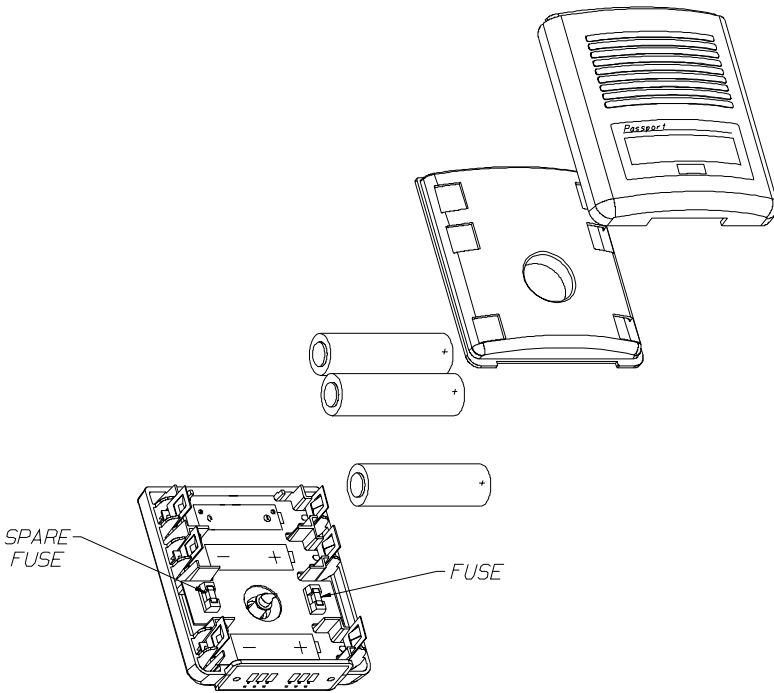

Figure 2-53.  
Battery and Fuse Location

3. Open the pack and remove the old batteries. (FIGURE 2-53).
  - Be sure to follow local regulations regarding battery disposal.
4. Install the new batteries.

### **⚠ CAUTION**

**When replacing the batteries in the pack, be sure to observe the direction of the positive (+) battery terminals. If the batteries are installed backwards and the battery pack is installed on the instrument, the instrument will fail to operate and the fuse in the battery pack may be blown.**

5. Close the battery pack case and re-tighten the 1/4-turn fastener.

6. Install the battery pack on the instrument.
  - If fresh batteries fail to properly initialize your instrument, verify proper battery installation.

## To Replace the Fuse

If the battery pack fuse has blown:

1. Remove and open the battery pack.
2. Locate and remove the blown fuse (FIGURE 2-53).  
**NOTE:** Non-operational fuses do not provide a visual indication. To ensure a fuse is operational, a continuity check may be performed by using a standard multimeter.
3. Locate the spare fuse on the other side of the battery pack board.
4. Remove spare fuse from its holder and install it in the main fuse holder.
5. Reassemble the battery pack, and reinstall it on the instrument.

# Chapter 3

## General Maintenance

As with all electronic equipment, the FiveStar Alarm will operate only if it is cared for and maintained properly.

### ⚠ WARNING

Repair or alteration of the FiveStar Alarm beyond the procedures described in this manual or by anyone other than a person authorized by MSA could cause the instrument to fail to perform properly. Use only genuine MSA replacement parts when performing any maintenance procedures described in this manual. Substitution of components can seriously impair instrument performance, alter intrinsic safety characteristics or avoid agency approvals.

## Cleaning and Routine Care

The case of the FiveStar Alarm should be cleaned periodically with a soft cloth dampened with water. If any sensor holes on the front of the instrument are blocked with dirt, they must be cleaned:

1. Remove sensor cover plate.
2. Clean the holes in the plate with a paper clip, wire, or similar device. The holes may also be cleaned with oil-free compressed air.

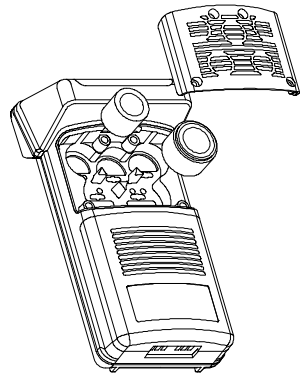

Figure 3-1.  
Sensor Cover Plate

### ⚠ CAUTION

Do not attempt to clean the sensor cover plate while it is in place; otherwise, sensor damage can occur. The tops of sensors are very fragile; do not touch or apply pressure to the tops of any sensors. If a sensor is damaged it can cause the unit to give false readings.

The sensor cover plate contains holes for five sensors. In instruments with less than five sensors, some of these holes are permanently blocked with special sealing membranes. Do not puncture these membranes; otherwise, erroneous gas readings can result.

## Storage

Store your FiveStar Alarm in a safe, dry place when it is not in use. The optimum storage temperature is between 23 and 104 degrees Fahrenheit (-5 and 40 degrees Celsius).

- The FiveStar Alarm with rechargeable battery packs can be stored on charge indefinitely.

## Storage for Models with Nitric Oxide (NO) or Ammonia (NH<sub>3</sub>) Sensors

These models draw a small amount of power at all times (even when turned OFF) in order to maintain a voltage on toxic gas sensors and keep them ready for immediate use.

- When the FiveStar Alarm is stored for less than 20 days, recharge the rechargeable battery pack or replace alkaline batteries before storing.
- To store these models for more than 20 days, attach the unit to a battery charger and charge with the proper MSA charger or periodically replace alkaline batteries with fresh cells.
- If the instrument was stored without a charged battery attached, attach the pack; then, allow the NO or NH<sub>3</sub> sensor to stabilize for 12 hours with the battery attached prior to calibration and use.

### **WARNING**

**After storage, always recheck instrument calibration before use. During storage, sensors may drift or become inoperative and may not provide warnings of danger to the health and lives of users.**

## Shipment

1. Remove battery pack before shipment. When returning the FiveStar Alarm for repairs, disconnect the normally used battery pack from the unit, and include it in the container.

2. Pack the FiveStar Alarm in its original shipping container with suitable padding. If the original container is unavailable, an equivalent container may be substituted if necessary. In either case, seal the instrument in a plastic bag to protect it from moisture. Protect the FiveStar Alarm from the rigors of handling with sufficient padding. Damage due to improper packaging or damage in shipment is not covered by the instrument's warranty.

## Checking the Pump and Aspirator Inlet Filter

The Pump Module and Aspirator Assembly contains a filtering system to protect the pump from particles and water in the sample air. If the filter becomes clogged, the sample flow may be blocked or an extra load placed on the pump; therefore, check the filter regularly.

The frequency of the checks should depend on the amount of pump usage and the concentration of particles allowed to enter the pump. In dirty applications it is suggested that the dust filter be replaced every 200 hours. (See Filtering System Replacement Parts List table at right.)

### Replacing the Filters

**NOTE:** Exercise care when replacing the external dust and water filters to prevent dust and dirt around the filter housing from entering the pump housing. Any dirt sucked into the pump and drive unit may damage pump operation.

### Dust Filter

1. Remove screws from the clear filter housing on top of the pump.
2. Remove the fibrous dust filter from the recess on the filter housing.
3. Install the new dust filter into the recess.
4. Replace cover.

## Water Filter

1. Remove the clear filter housing cover.
2. Carefully lift out the O-ring and white plastic disk resting in the pump housing.
3. Replace the water filter, placing it carefully into the molded recess on the pump housing.

**NOTE:** When replacing the filter, be sure to handle the new one carefully, by the edges only, as it is easily torn. Install the filters in the correct order.

4. Replace the O-ring, being sure to press *gently* down on top of the water filter.
5. Replace cover.

## Internal "Firewall" Filter - Pump Module

The pump module is provided with an internal "firewall" filter to form a final barrier against any dust that enters the pump assembly when the external filters are replaced. This filter is provided as a final safety precaution and should rarely, if ever, need to be replaced.

1. Remove the four screws from the bottom of the pump housing.
2. Remove the back lid; note the tubing seating.
3. Carefully remove the old filter by pulling the tubing off the barbed end fittings.
4. Install a new filter by pushing tubing over the end fittings.
5. Replace tubing in the pump housing. Seat tubing and pump and drive unit in a similar manner as found when disassembled.
6. Replace the housing screws. Gently rethread the screws, guiding them into the same threads as initially cut.

# Chapter 4 Performance Specifications

## Instrument Specifications

Table 4-1. Instrument Specifications		
<b>TEMPERATURE RANGE</b>	<b>Normal</b>	0 to 40° C
	<b>Extended**</b>	-20 to 50° C
<b>WARM-UP TIME</b>	<b>With FAS</b>	40 seconds; 45 seconds with pump
	<b>No FAS</b>	20 seconds; 25 seconds with pump
<b>PRESSURE RANGE</b>		80 kPa (560 mmHg) to 133 kPa (1010 mmHg)
<p><b>*NOTE 1:</b> Response times reported for diffusion usage: When using a pump module and sample line, add time for the gas sample to be drawn through the sample line. Typical transport times are:</p>		
	10 feet	3 seconds
	5 feet	7 seconds
	50 feet	15 seconds
<p>These should be added to the sensor response times reported in this Table.</p>		
<p><b>**NOTE 2:</b> Extended temperature range indicates that gas readings may vary slightly if calibrated at room temperature. For optimal performance, it is recommended that the instrument be calibrated at temperature of use.</p>		
Measurement Methods		
<b>COMBUSTIBLE GAS</b>	Catalytic Sensor	
<b>OXYGEN</b>	Electrochemical Sensor	
<b>TOXIC GASES</b>	Electrochemical Sensors	

<b>Approximate Battery Run Times</b>		
<b>NORTH AMERICAN APPROVED INSTRUMENT</b>	<b>FIVESTAR Alarm OPERATING TIME (WITHOUT DERATING/ AT 20°C)</b>	
<b>BATTERY TYPE</b>	<b>WITHOUT PUMP</b>	<b>WITH PUMP</b>
Ni Cad Standard	10-12 hours	8-10 hours
NiMH Heavy-duty	18-21 hours	14-16 hours
Lithium	11 hours	9 hours
Alkaline	7 hours	5 hours
<b>EN AND AUSTRALIAN APPROVED INSTRUMENT</b>	<b>FIVESTAR Alarm OPERATING TIME (WITHOUT DERATING/ AT 20°C)</b>	
<b>BATTERY TYPE</b>	<b>WITHOUT PUMP</b>	<b>WITH PUMP</b>
Ni Cad Standard	8 hours	6 hours
NiMH Heavy-duty	16-20 hours	13-16 hours

**NOTE:** In colder temperatures, battery output may be severely reduced. The following table shows capacity reductions expected for replaceable batteries at these temperatures.

<b>Capacity Reductions Expected for Batteries at Colder Temperatures</b>				
<b>TEMPERATURE</b>	<b>NiCd</b>	<b>NiMH</b>	<b>AA ALKALINE</b>	<b>AA LITHIUM</b>
70°F (21°C)	None	None	None	None
32°F (0°C)	10%	20%	25%	15%
14°F (-10°C)	20%	30%	60%	40%

## Combustible Gas Sensor Specifications

**Table 4-2. COMBUSTIBLE GAS - Typical Performance Specifications**

<b>RANGE</b>	0 to 100% LEL or 0 to 5% CH <sub>4</sub>
<b>RESOLUTION</b>	1% LEL or 0.1% CH <sub>4</sub>
<b>REPRODUCIBILITY</b>	3% LEL to 50% LEL reading 5% LEL to full scale or 0.2% CH <sub>4</sub> to 2.5% Methane 0.3% CH <sub>4</sub> to full scale
<b>RESPONSE TIME</b>	90% of final reading in 30 seconds (normal temperature range)*
*See TABLE 4-1, NOTE 1.	

**Table 4-3. COMBUSTIBLE GAS - Cross Reference Factors for FiveStar General-Purpose Calibration Using Calibration Cylinder (P/N 478191), (P/N 478192), (P/N 804769), or (P/N 804770) Set to 58% LEL**

COMBUSTIBLE GAS	MULTIPLY %LEL READING BY	COMBUSTIBLE GAS	MULTIPLY %LEL READING BY
Acetone	1.1	Methyl Ethyl Ketone	1.1
Acetylene	0.7	Methyl Tertiary Butyl Ether	1.0
Acrylonitrile <sup>1</sup>	0.8	Mineral Spirits	1.1
Benzene	1.1	iso-Octane	1.1
Butane	1.0	n-Pentane	1.0
1,3 Butadiene	0.9	Propane	0.8
n-Butanol	1.8	Propylene	0.8
Carbon Disulfide <sup>1</sup>	2.2	Styrene <sup>2</sup>	1.9
Cyclohexane	1.1	Tetrahydrofuran	0.9
2,2 Dimethylbutane	1.2	Toluene	1.1
2,3 Dimethylpentane	1.2	Vinyl Acetate	0.9
Ethane	0.7	VM&P Naptha	1.6
Ethyl Acetate	1.2	O-Xylene	1.2
Ethyl Alcohol	0.8		
Ethylene	0.7		
Formaldehyde <sup>2</sup>	0.5		
Gasoline (unleaded)	1.3		
Heptane	1.1		
Hydrogen	0.6		
n-Hexane	1.3		
Isobutane	0.9		
Isobutyl Acetate	1.5		
Isopropyl Alcohol	1.1		
Methane	0.5		
Methanol	0.6		
Methyl Isobutyl ketone	1.1		
Methylcyclohexane	1.1		

**RESPONSE NOTES:**

1. The compounds may reduce the sensitivity of the combustible gas sensor by poisoning or inhibiting the catalytic action.
2. These compounds may reduce the sensitivity of the combustible gas sensor by polymerizing on the catalytic surface.
3. For an instrument calibrated on Pentane, multiply the displayed %LEL value by the conversion factor above to get the true %LEL.
4. These conversion factors should be used only if the combustible gas is known.
5. These conversion factors are typical for a Portable Alarm. Individual units may vary by ± 25% from these values.

## Oxygen Sensor Specifications

Table 4-4. OXYGEN - Typical Performance Specifications	
<b>RANGE</b>	0 to 25% O <sub>2</sub>
<b>RESOLUTION</b>	0.1% O <sub>2</sub>
<b>REPRODUCIBILITY</b>	0.5% O <sub>2</sub> , for 18 to 25% O <sub>2</sub> ; 0.8% for less than 18%
<b>RESPONSE TIME</b>	90% of final reading
	30 seconds (normal temperature range)* 3 minutes (extended temperature range)
*See TABLE 4-1, NOTE 1.	

### Environment and Oxygen Sensor Readings

A number of environmental factors may affect the oxygen sensor readings, including changes in pressure, humidity and temperature. Pressure and humidity changes affect the amount of oxygen actually present in the atmosphere.

#### Pressure Changes

The FiveStar Alarm has a built-in pressure sensor to rapidly compensate for ambient pressure changes in the area of instrument operation. If pressure changes rapidly (e.g., stepping through airlock) the oxygen sensor reading may temporarily shift, and possibly cause the detector to go into alarm. Allow up to 30 seconds for the pressure sensor to update the oxygen sensor reading; then, reset any alarms. While the percentage of oxygen may remain at or near 20.8%, the total amount of oxygen present in the atmosphere available for respiration may become a hazard if the overall pressure is reduced to a significant degree.

#### Humidity Changes

If humidity changes to any significant degree (e.g., going from a dry, air conditioned environment to outdoor, moisture laden air), oxygen levels can change up to 0.5%. This is due to water vapor in the air displacing oxygen, thus reducing oxygen readings as humidity increases. The oxygen sensor has a special filter to reduce the affects of humidity changes on oxygen readings. This effect will not be noticed immediately, but slowly impacts oxygen readings over several hours.

#### Temperature Changes

The oxygen sensor has built-in temperature compensation. However, if temperature shifts dramatically, the oxygen sensor reading may shift. Zero the instrument to within 30°C of the temperature-of-use for the least effect.

## Carbon Monoxide Sensor Specifications

<b>Table 4-5. CARBON MONOXIDE (appropriate models only) - Typical Performance Specifications</b>	
<b>RANGE</b>	2000 ppm CO
<b>RESOLUTION</b>	1 ppm CO
<b>REPRODUCIBILITY</b>	±2 ppm CO or 10% of reading, whichever is greater
<b>RESPONSE TIME</b>	90% of final reading in 30 seconds (normal temperature range)

<b>Table 4-6. - CARBON MONOXIDE - Cross Reference Factors for FiveStar Calibration Using Calibration Cylinder (P/N 478191) or (P/N 804770)</b>	
<b>NOTE:</b> Data is presented as the indicated output in ppm, which would result from the application of 100 ppm of the test gas.	
<b>TEST GAS (100 PPM)</b>	<b>EQUIVALENT PPM</b>
Carbon Monoxide (CO)	100 ±9
Hydrogen Sulfide (H <sub>2</sub> S)	1 ±6
Sulfur Dioxide (SO <sub>2</sub> )	0 ±1
Nitrogen Dioxide (NO <sub>2</sub> )	2 ±6
Nitric Oxide (NO)	70 ±10
Chlorine (Cl <sub>2</sub> )	1 ±8
Ammonia (NH <sub>3</sub> )	2 ±4
Hydrogen Chloride (HCl)	3 ±2
Ethylene (C <sub>2</sub> H <sub>4</sub> )	80 ±9
Hydrogen Cyanide (HCN)	0 ±1
Methane (CH <sub>4</sub> )	0 ±0
Ethanol (EtOH)	4 ±5
Hydrogen (H <sub>2</sub> )	70 ±26
Chlorine Dioxide (ClO <sub>2</sub> )	0
<b>NOTE:</b> Unsaturated hydrocarbons, such as ethylene, will have a significant positive reaction with the CO sensors	

## Hydrogen Sulfide Sensor Specifications

<b>Table 4-7. HYDROGEN SULFIDE (appropriate models only) - Typical Performance Specifications</b>	
<b>RANGE</b>	500 ppm H <sub>2</sub> S (200 ppm before August of 1999)
<b>RESOLUTION</b>	1 ppm H <sub>2</sub> S
<b>REPRODUCIBILITY</b>	±2 ppm H <sub>2</sub> S or 10% of reading, whichever is greater
<b>RESPONSE TIME</b>	90% of final reading in 30 seconds* (normal temperature range)
*See TABLE 4-1, NOTE 1.	

<b>Table 4-8. HYDROGEN SULFIDE - Cross Reference Factors for FiveStar Calibration Using Calibration Cylinder (P/N 804769) or (P/N 804770) Set to 10 ppm H<sub>2</sub>S</b>	
<b>NOTE:</b> Data is presented as the indicated output in ppm, which would result from the application of 100 ppm of the test gas.	
<b>TEST GAS (100 PPM)</b>	<b>EQUIVALENT PPM</b>
Hydrogen Sulfide (H <sub>2</sub> S)	100 ±10
Ethylene (C <sub>2</sub> H <sub>4</sub> )	0 ±0
Methane (CH <sub>4</sub> )	0 ±0
Hydrogen (H <sub>2</sub> )	0 ±0
Ammonia (NH <sub>3</sub> )	0 ±0
Chlorine (Cl <sub>2</sub> )	0 ±0
Nitrogen Dioxide (NO <sub>2</sub> )	-20 ±2
Nitric Oxide (NO)	1 ±1
Carbon Monoxide (CO)	0 ±0
Hydrogen Chloride (HCl)	0 ±0
Hydrogen Cyanide (HCN)	1 ±1
Sulfur Dioxide (SO <sub>2</sub> )	10 ±3
Ethanol (EtOH)	0 ±0
Toluene	0 ±0
Chlorine Dioxide (ClO <sub>2</sub> )	0

## Nitric Oxide Sensor Specifications

<b>Table 4-9. NITRIC OXIDE (appropriate models only) - Typical Performance Specifications</b>	
<b>RANGE</b>	100 ppm
<b>RESOLUTION</b>	1 ppm
<b>REPRODUCIBILITY</b>	±2 ppm or ±10% of reading, whichever is greater
<b>RESPONSE TIME</b>	25 seconds*
*See TABLE 4-1, NOTE 1.	

<b>Table 4-10. NITRIC OXIDE- Cross Reference Factors for FiveStar Calibration Using Calibration Cylinder (P/N 812144) Set to 50 ppm NO</b>	
<b>NOTE:</b> Data is presented as the indicated output in ppm, which would result from the application of 100 ppm of the test gas.	
<b>TEST GAS</b>	<b>EQUIVALENT PPM</b>
Carbon Monoxide (CO)	0
Hydrogen Sulfide (H <sub>2</sub> S)	1
Nitrogen Dioxide (NO <sub>2</sub> )	30 ±5
Sulfur Dioxide (SO <sub>2</sub> )	0
Ammonia (NH <sub>3</sub> )	0
Carbon Dioxide (CO <sub>2</sub> )	0
Chlorine Dioxide (ClO <sub>2</sub> )	75

## Nitrogen Dioxide Sensor Specifications

**Table 4-11. NITROGEN DIOXIDE (appropriate models only) - Typical Performance Specifications**

<b>RANGE</b>	100 ppm
<b>RESOLUTION</b>	0.5 ppm
<b>REPRODUCIBILITY</b>	$\pm 2$ ppm or $\pm 10\%$ of reading, whichever is greater
<b>RESPONSE TIME</b>	50 seconds*
*See TABLE 4-1, NOTE 1.	

**Table 4-12. NITROGEN DIOXIDE - Cross Reference Factors for FiveStar Calibration Using Calibration Cylinder (P/N 808977) Set to 10 ppm NO<sub>2</sub>**

**NOTE:** Data is presented as the indicated output in ppm, which would result from the application of 100 ppm of the test gas.

TEST GAS	EQUIVALENT PPM
Carbon Monoxide (CO)	< -5
Hydrogen Sulfide (H <sub>2</sub> S)	-8 $\pm$ 2
Nitric Oxide (NO)	0
Sulfur Dioxide (SO <sub>2</sub> )	0
Chlorine (Cl <sub>2</sub> )	-100 $\pm$ 15
Ammonia (NH <sub>3</sub> )	0
Carbon Dioxide (CO <sub>2</sub> )	0
Chlorine Dioxide (ClO <sub>2</sub> )	150 (over)

## Sulfur Dioxide Sensor Specifications

<b>Table 4-13. SULFUR DIOXIDE (appropriate models only) - Typical Performance Specifications</b>	
<b>RANGE</b>	100 ppm
<b>RESOLUTION</b>	0.5 ppm
<b>REPRODUCIBILITY</b>	±2 ppm or ±10% of reading, whichever is greater
<b>RESPONSE TIME</b>	50 seconds*
*See TABLE 4-1, NOTE 1.	

<b>Table 4-14. SULFUR DIOXIDE - Cross Reference Factors for FiveStar Calibration Using Calibration Cylinder (P/N 808978) Set to 10 ppm SO<sub>2</sub></b>	
<b>NOTE:</b> Data is presented as the indicated output in ppm, which would result from the application of 100 ppm of the test gas.	
<b>TEST GAS</b>	<b>EQUIVALENT PPM</b>
Carbon Monoxide (CO)	< 1
Hydrogen Sulfide (H <sub>2</sub> S)	< 1
Nitric Oxide (NO)	< 1
Nitrogen Dioxide (NO <sub>2</sub> )	approximately -100 ppm
Ammonia (NH <sub>3</sub> )	0
Carbon Dioxide (CO <sub>2</sub> )	0
<b>NOTE:</b> Chlorine and Chlorine Dioxide have a significant negative cross-interference with the SO <sub>2</sub> sensor.	

## Ammonia Sensor Specifications

Table 4-15. AMMONIA (appropriate models only) Typical Performance Specifications	
<b>RANGE</b>	0 to 50 ppm
<b>RESOLUTION</b>	1 ppm
<b>RESPONSE TIME</b>	$t_{50}$ = 18 seconds
	$t_{90}$ = 310 seconds
<b>TEMPERATURE RANGE</b>	-30 to +30°C

### General Information

The Ammonia Sensor helps provide an indication of exposure to toxic ammonia gas. Unlike many other FiveStar Alarm sensors, chemicals in the Ammonia Sensor are actively consumed through exposure to ammonia gas; therefore, Ammonia Sensor life is limited by continuous exposure to ammonia. In addition, to maintain internal chemistry stability, the sensor must be installed in a "biased" position ("TOX 3" only) in the instrument.

The FiveStar Ammonia Sensor also exhibits a strong response to hydrogen sulfide and sulfur dioxide. Exposures to these gases will further reduce the expected life of the Ammonia Sensor. Therefore, it is *not* recommended that the Ammonia Sensor be used in an environment where it will be exposed regularly to these two gases.

### Zero Stability (FIGURE 4-1)

The zero reading of the FiveStar Alarm Ammonia Sensor may experience some small amount of drift with changes in ambient temperature.

It is recommended that a Fresh Air Setup be performed at the temperature of use if the area to be monitored significantly differs from that of the location where the instrument was last zeroed.

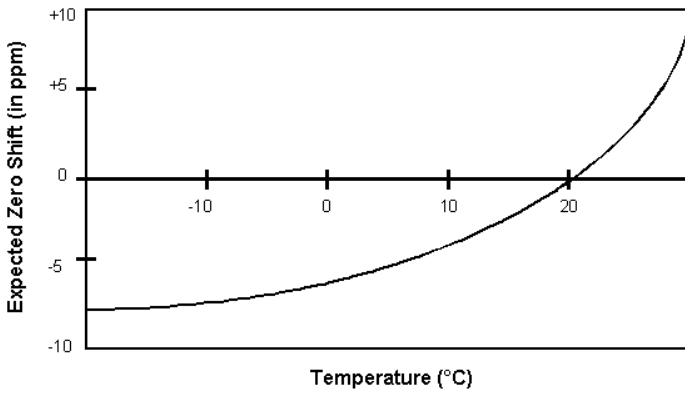

Figure 4-1. Ammonia Sensor Zero Stability

<b>Table 4-16. AMMONIA Cross Reference Factors</b>		
<b>GAS</b>	<b>CONCENTRATION (PPM)</b>	<b>SENSOR RESPONSE (PPM)</b>
Carbon Monoxide	300	0
Hydrogen Sulfide	15	(approx.) 15
Sulfur Dioxide	5	(approx.) 4
Nitric Oxide	35	(approx.) 7
Nitrogen Dioxide	5	0
Chlorine	1	(approx.) 0.5
Hydrogen	200	0
Hydrogen Cyanide	10	(approx.) 0.5
Hydrogen Chloride	5	0
Ethylene	100	0

## Phosphine Sensor Specifications

<b>Table 4-17. PHOSPHINE (appropriate models only) Typical Performance Specifications</b>	
<b>RANGE</b>	0 to 5 ppm
<b>RESOLUTION</b>	0.05 ppm
<b>REPRODUCIBILITY</b>	$\pm 0.2$ ppm or $\pm 10\%$ of reading, whichever is greater
<b>RESPONSE TIME</b>	time to 90% = 80 seconds

<b>Table 4-18. PHOSPHINE - Cross Reference Factors for FiveStar General-Purpose Calibration Using Calibration Cylinder (P/N 478191), (P/N 478192), (P/N 804769), or (P/N 804770) Set to 58% LEL</b>	
<b>NOTE:</b> Data is presented as the indicated output in ppm, which would result from the application of 100 ppm of the test gas.	
TEST GAS	EQUIVALENT PPM
Sulfur Dioxide (SO <sub>2</sub> )	20 $\pm$ 4
Hydrogen Sulfide (H <sub>2</sub> S)	>15
Ammonia (NH <sub>3</sub> )	0.00
Carbon Dioxide (CO <sub>2</sub> )	0.00
Carbon Monoxide (CO)	0.10
Nitric Oxide (NO)	-1.10

## Chlorine Sensor Specifications

<b>RANGE</b>	0 to 20 ppm
<b>RESOLUTION</b>	0.1 ppm
<b>REPRODUCIBILITY</b>	±15% at 10 ppm applied
<b>RESPONSE TIME</b>	t <sub>50</sub> = 25 seconds
	t <sub>90</sub> = 100 seconds

<b>NOTE:</b> Data is presented as the indicated output in ppm, which would result from the application of 100 ppm of the test gas.	
<b>TEST GAS</b>	<b>EQUIVALENT PPM</b>
Carbon Monoxide (CO)	0
Hydrogen Sulfide (H <sub>2</sub> S)	-14
Nitric Oxide (NO)	0
Nitrogen Dioxide (NO <sub>2</sub> )	1
Sulfur Dioxide (SO <sub>2</sub> )	0
Ammonia (NH <sub>3</sub> )	-1
Hydrogen Cyanide (HCN)	1
Hydrogen Chloride (HCl)	0
Ethylene (C <sub>2</sub> H <sub>4</sub> )	0
Chlorine Dioxide (ClO <sub>2</sub> )	200 (over)

### Special Instructions

Due to the high reactivity of chlorine gas, ambient humidity and sample line material can react with chlorine to cause the chlorine concentration reading to be lower than actual concentrations. It is therefore necessary when sampling for chlorine to use dry sample lines.

1. If condensation in the sample line is suspected, dry the sample line by running the pump module with the sample line attached in a low humidity atmosphere.
2. To verify operation of a FiveStar unit equipped with a chlorine sensor, perform response check with the sample line in place.
3. Since shorter sample lines will reduce the reaction with chlorine gas, calibrate and operate the instrument using the shortest possible tubing to connect to the calibration cylinder. Use no more than 10 feet of sample line for best results. Use only a dedicated regulator with your chlorine calibration cylinder.

The chlorine compatible pump has internal parts made of materials specially chosen to minimize their effects on chlorine. Therefore, the following parts must be installed on the FiveStar unit to properly sample for chlorine:

PART	PART NO.
Sensor Cover	10016244
Sensor Cover Filter	10016245
Pump (if used)	10018395

The chlorine compatible sensor cover and filter are easy to recognize; they are completely cut away over the Tox 3 position.

### **WARNING**

**Failure to use the appropriate sampling system and instrument parts when detecting chlorine may cause reduced readings. This may lead to serious personal injury or death.**

## Chlorine Dioxide Sensor Specifications

<b>Table 4-21. CHLORINE DIOXIDE Typical Performance Specifications</b>	
<b>RANGE</b>	0 to 4.95 ppm
<b>RESOLUTION</b>	0.05 ppm
<b>REPRODUCIBILITY</b>	±0.10 ppm
<b>RESPONSE TIME</b>	t <sub>50</sub> = 25 seconds
	t <sub>90</sub> = 90 seconds

<b>Table 4-22. CHLORINE DIOXIDE - Cross Reference Factors for FiveStar Calibration Using Calibration Cylinder (P/N 806740) Set to 4.95 ppm</b>	
<b>NOTE:</b> Data is presented as the indicated output in ppm, which would result from the application of 100 ppm of the test gas.	
<b>TEST GAS</b>	<b>EQUIVALENT PPM</b>
Sulfur Dioxide (SO <sub>2</sub> )	0
Nitric Oxide (NO)	2.80
Nitrogen Dioxide (NO <sub>2</sub> )	33.5 (over)
Methane (CH <sub>4</sub> ) - (1.45%)	0
Carbon Monoxide (CO)	0
Hydrogen Sulfide (H <sub>2</sub> S)	0
Ammonia (NH <sub>3</sub> )	Known negative interference
Phosphine (PH <sub>3</sub> )	0
Chlorine (Cl <sub>2</sub> )	50 (over)

### Special Instructions

Due to the high reactivity of chlorine dioxide gas, ambient humidity and sample line material can react with chlorine dioxide to cause the chlorine dioxide concentration reading to be lower than actual concentrations. It is therefore necessary when sampling for chlorine dioxide to use dry sample lines.

1. If condensation in the sample line is suspected, dry the sample line by running the pump module with the sample line attached in a low humidity atmosphere.

2. To verify operation of a FiveStar unit equipped with a chlorine dioxide sensor, perform response check with the sample line in place.
3. Since chlorine dioxide is not readily available in cylinders, it is recommended that either chlorine gas or a chlorine dioxide generator be used to perform the chlorine dioxide calibration check. When using chlorine as a check gas, the reading should be 1/2 (50%) of the known concentration of the cylinder (e.g., 2 ppm chlorine should read approximately 1 ppm chlorine dioxide).
4. Since shorter sample lines will reduce the reaction with chlorine gas, calibrate and operate the instrument using the shortest possible tubing to connect to the calibration cylinder. Use no more than 10 feet of sample line for best results. Use only a dedicated regulator with your chlorine calibration cylinder.

The chlorine dioxide compatible pump has internal parts made of materials specially chosen to minimize their effects on chlorine dioxide. Therefore, the following parts must be installed on the FiveStar unit to properly sample for chlorine dioxide:

PART	PART NO.
Sensor Cover	10016244
Sensor Cover Filter	10016245
Pump (if used)	10018395

The chlorine dioxide compatible sensor cover and filter are easy to recognize; they are completely cut away over the Tox 3 position.

### **WARNING**

**Failure to use the appropriate sampling system and instrument parts when detecting chlorine dioxide may cause reduced readings. This may lead to serious personal injury or death.**

# Chapter 5

## Accessories Parts List

Table 5-1. Parts List				
PART	NORTH AMERICAN APPROVED INSTRUMENT		AUSTRALIAN APPROVED INSTRUMENT	EN APPROVED INSTRUMENT
	NICKEL PLATED	BLACK ABS PART NO.	PART NO.	PART NO.
Pump Assembly	10008609	710790	10007440	10008724
Aspirator Assembly	10008608	710959	10009305	10008608
Calibration Cap	710824		710824	710824
Probe - 1 ft.	800332		800332	*
Probe - 3 ft.	800333		800333	*
Sampling Line - 5 ft.	497332		497332	*
Sampling Line - 10 ft.	497333		497333	*
Sampling Line - 15 ft.	497334		497334	*
Sampling Line - 25 ft.	497335		497335	*
Replacement Filter, Probe (package of 10)	801582		801582	*
Calibration Kit Model RP with 0.25 lpm Regulator	477149		477149	477149
Calibration Gas - LEL Pentane Simulant / 15% Oxygen	478192		478192	478192
Calibration Gas, 58% LEL pentane simulant / 15% oxygen, 300 ppm CO	10010162		10010162	10010162
Calibration Gas - LEL pentane simulant / 15% Oxygen; 300 ppm CO and 10 ppm Hydrogen Sulfide	804770		804770	804770
Calibration Gas - LEL Pentane Simulant / 15% Oxygen; 10 ppm Hydrogen Sulfide	804769		804769	804769

**Table 5-2. Battery Pack and Charger Parts List**

<b>PART</b>	<b>NORTH AMERICAN APPROVED PART NO.</b>	<b>AUSTRALIAN APPROVED PART NO.</b>	<b>EN APPROVED PART NO.</b>
Battery Pack Assembly for Replaceable Batteries, Standard	710955	10007351	N/A
Battery Pack Assembly for Replaceable Batteries, Plated	10008607	N/A	N/A
Spare Fuses for Battery Pack Assembly	655836	10006582	N/A
Replacement Internal Gasket for Battery Pack Assembly	710958	710958	N/A
Battery Pack, Ni-Cad Rechargeable, Standard	710427	711024	N/A
Battery Pack, Standard Ni-Cad Rechargeable, Plated	10008606	N/A	10013094
Battery Pack, Heavy-Duty NiMH, Rechargeable, Standard	10008642	10005691	N/A
Battery Pack, Heavy-Duty NiMH, Rechargeable, Plated	10013145	N/A	N/A
Charger, Omega 8-28 VDC	800525	N/A	N/A
Charger, Omega 120 VAC	494716	N/A	N/A
Charger, Omega 220 VAC	495965	N/A	N/A
Charger, 5 Unit, Omega 110/120 VAC	801759	N/A	N/A
Charger Stand, Omega	710570	N/A	N/A
Kit, Universal Fast Charger	10065553	*	10065556
• Stand, Universal Fast Charger	10065552	*	N/A
• Power Supply, Universal Fast Charger	710774	*	10013426
*These accessories may vary according to the country of use; please contact your nearest MSA Distributor Office for details.			