



Using the MeshGuard



Turning on the MeshGuard

- Hold down the [M] key and release it when the MeshGuard beeps.
- The MeshGuard performs a self-test, followed by warm-up and zero calibration.
- The display briefly shows the firmware version

A digital display showing the number '0.07' in a seven-segment font.A digital display showing the text 'F2.2' in a seven-segment font.

Turning on the MeshGuard



rdo



InI

- The MeshGuard initializes the wireless network
- The display alternates between “rdo” and “InI” (for “radio initialization”)
- Note: If MeshGuard is unable to find a radio network to connect with, it searches, and the display alternates between “rdo” and “SrH” (for “radio search”).

Radio Communication

- The display tells you that MeshGuard is initiating network communication
- If a network is located, an antenna icon appears (if no network is found, press [+/Y] to search for a network).

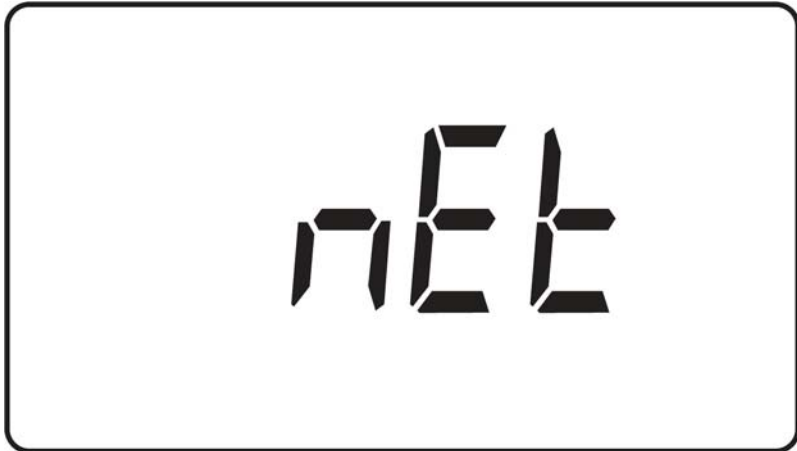

Using the MeshGuard

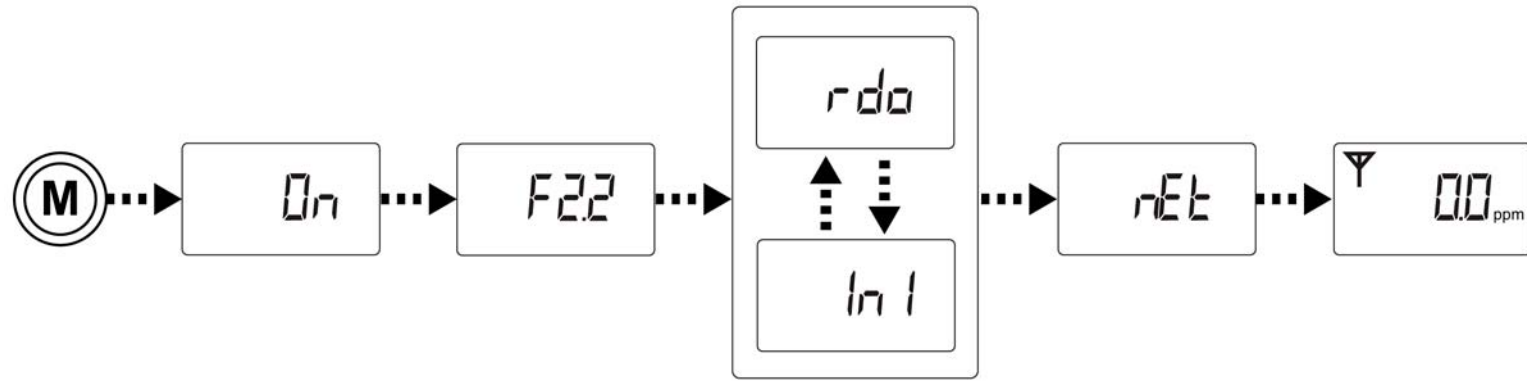

- Once a network is found, the MeshGuard is now operational

Turning off the MeshGuard



OFF

- Hold down the [M] key through the “5...4...3... 2... 1... oFF” sequence.
- The monitor is off when the display is blank.
- Release the [M] key.
- The MeshGuard is now off.

Operation Modes

The MeshGuard can operate as a Reduced Function Device (RFD) or a Full Function Device (FFD).

- In RFD mode, the MeshGuard transmits data to the host at a set interval (the default is 30 seconds) or anytime an alarm occurs.
- In FFD mode, the MeshGuard receives data in real time, and it can also work as a router as needed to relay data from RFD devices back to the host
 - **Note:** Operating the MeshGuard in FFD mode reduces battery life.
 - The interval can be changed in Programming Mode.



Operation Modes

The MeshGuard has 4 Operation modes

- Detection Mode for standard operation
- Programming Mode for making changes to values (such as the High Alarm, etc.)
- Diagnostic Mode (for servicing and checking the sensor, etc.), and
- Diagnostic Programming Mode, which is for selecting the sensor type, etc.

Detection Mode

- The MeshGuard can operate in fixed or portable mode.
- Whenever you start MeshGuard, it is automatically in fixed Detection Mode, which is the default.
- The MeshGuard displays the current reading.
- Press [M], and it displays the sensor type



Detection Mode

- Pressing [M] steps through the Detection Mode screens

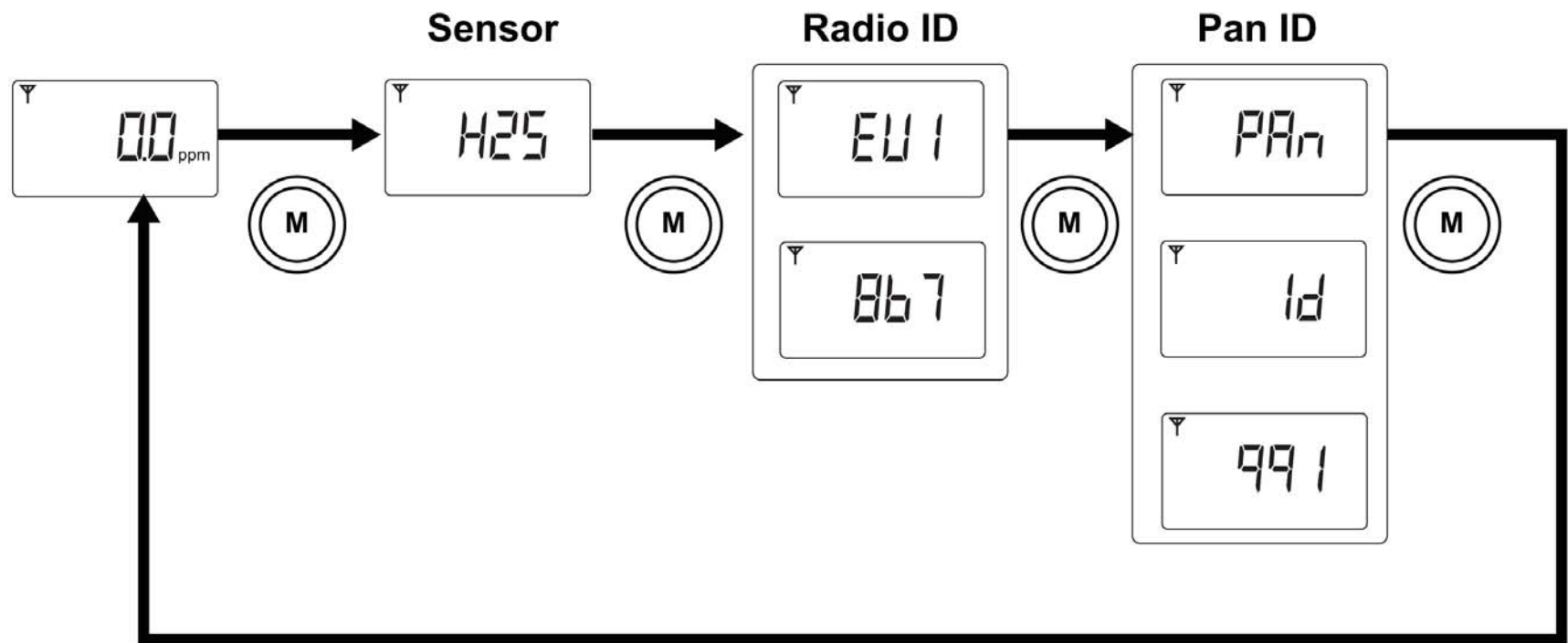

Detection Mode



- Press [M], and it alternates between EUI (Extended Unique Identifier) and its value

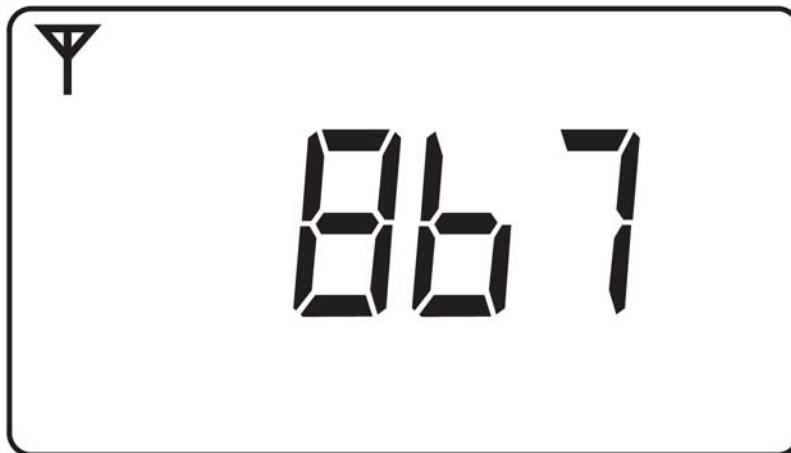

Detection Mode

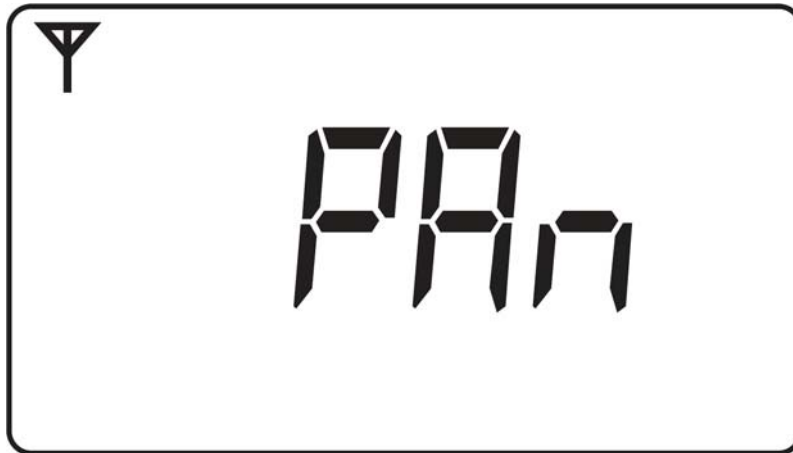

- Press [M], and it alternates between Pan and ID (Personal Area Network Identifier) and its value:



Detection Mode



- Press [M] to return to the detector reading

Manually Sending Data

- While the MeshGuard typically sends reading data to the network on a fixed interval, you can send the data anytime.
- Press the [+/Y] key
- The screen alternates between “Ini” and “nEt” one time, sends the current sensor data, and returns to the detector reading.

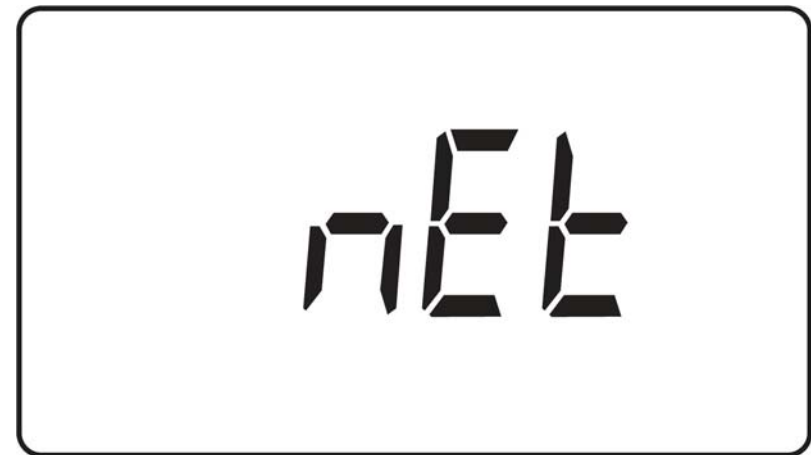
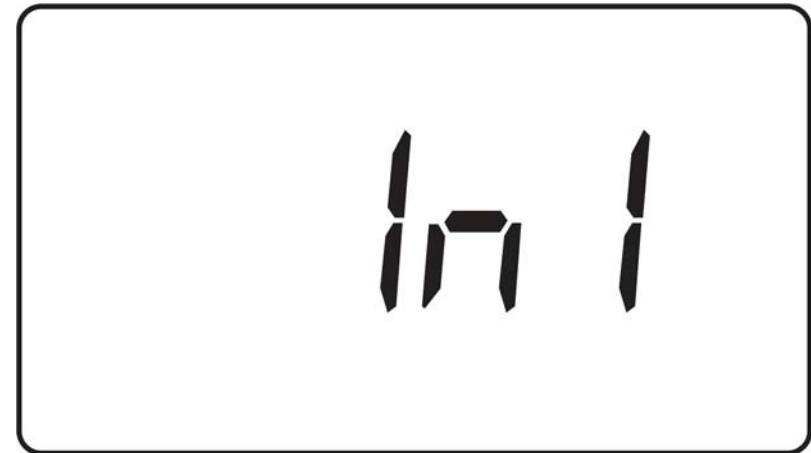

Detection Mode

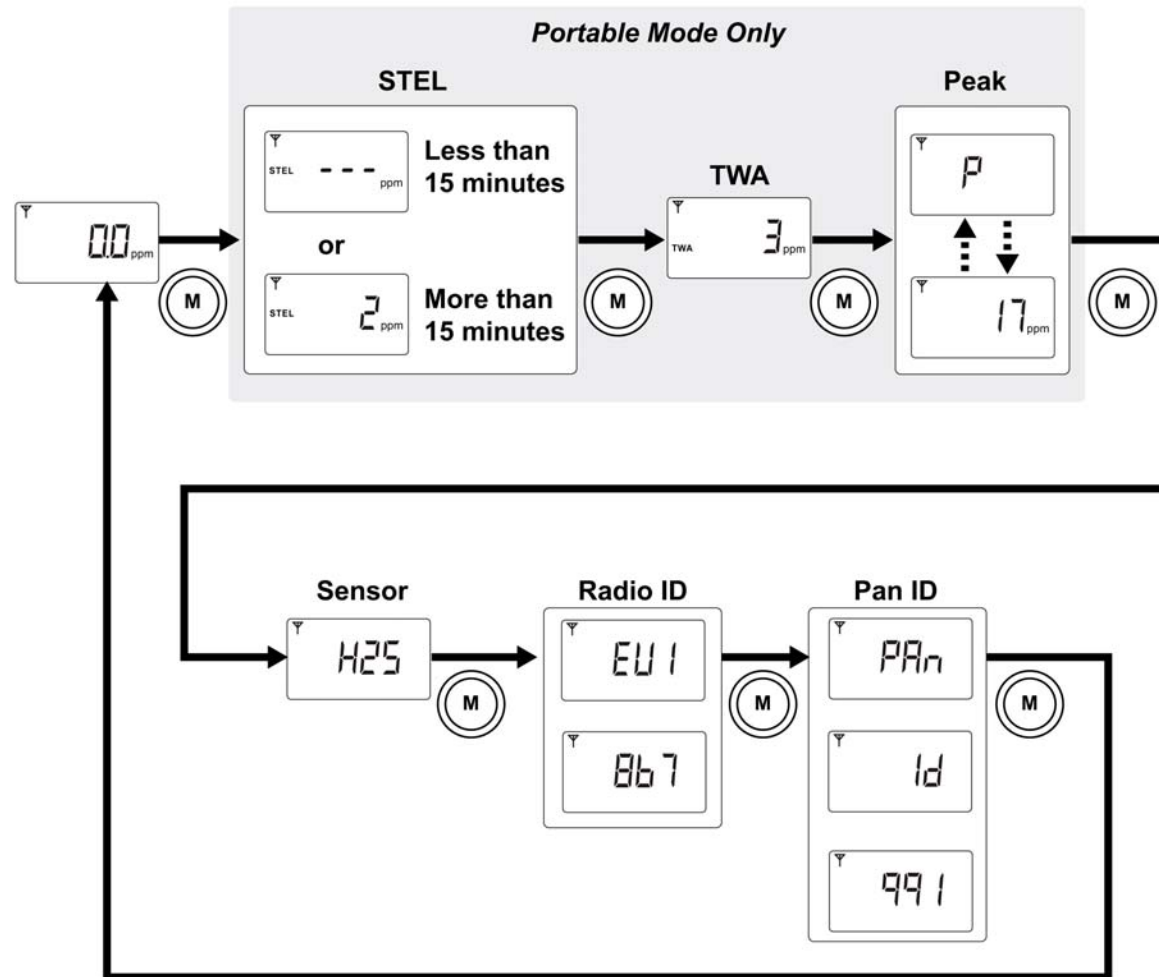

Detection Mode

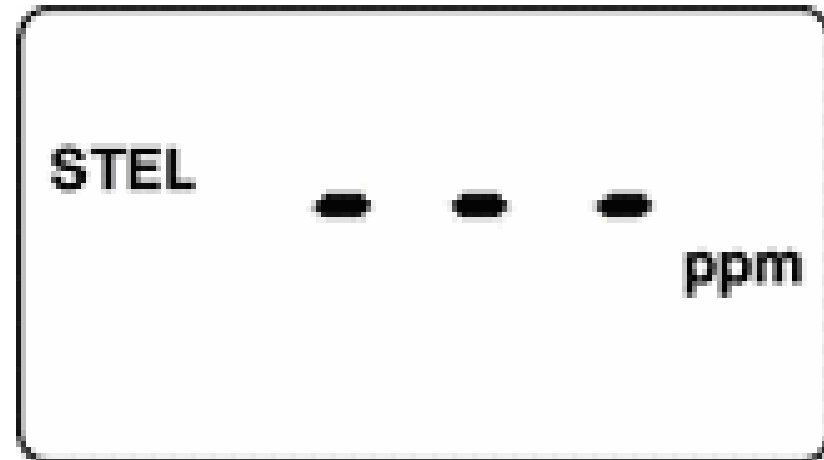
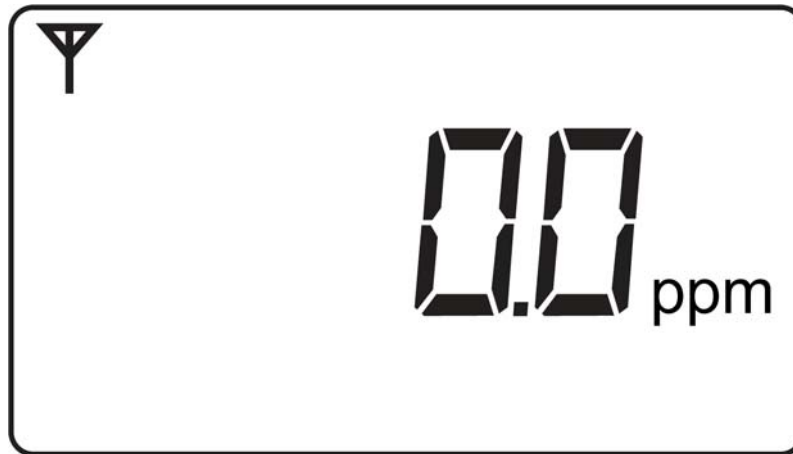

- When Portable Mode is enabled, pressing [M] steps through three more screens, STEL, TWA, and Peak
- Press [M], and it displays STEL.
- The STEL (short-term exposure limit) is the average reading of the gas concentration for the last 15 minutes.
 - **Note:** The STEL reading does not appear until 15 minutes have elapsed. If the MeshGuard has not been on for 15 minutes, it displays three dashes

Detection Mode

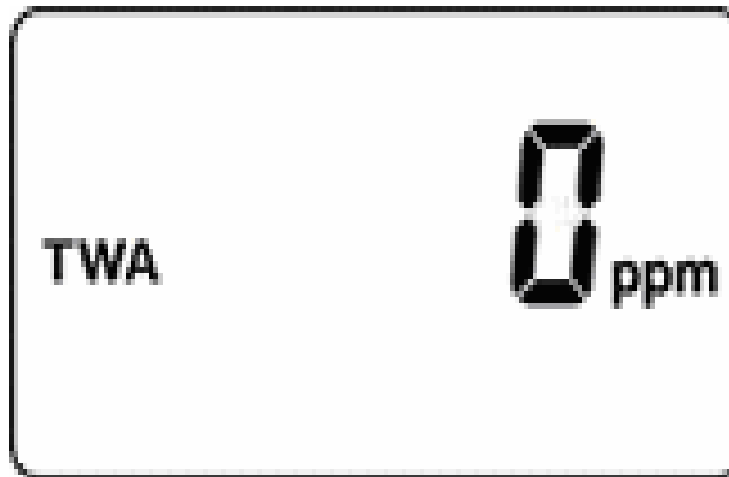

- Press [M], and it displays TWA.
- The TWA (time-weighted average) is the accumulated reading of the gas concentration, divided by 8 hours, since the monitor was turned on.

Detection Mode

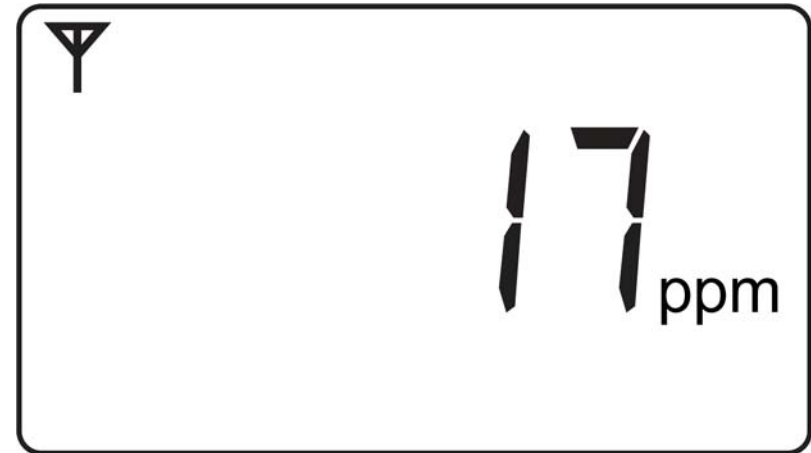
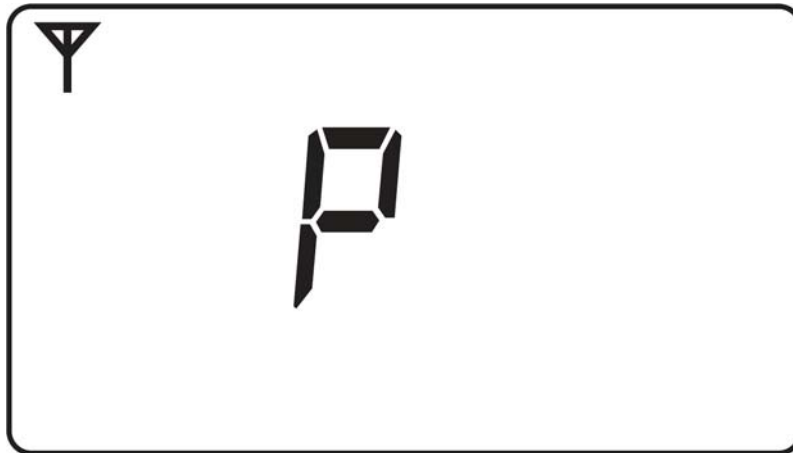

- Press [M], and the display indicates the Peak reading by alternating between “P” (for “Peak”) and a numerical value
- Press [M] to return to the current reading

Programming Mode

- Programming Mode allows you to perform any of the following actions (listed in order of appearance)
 - Calibrate the MeshGuard
 - Changing Preset Limits or Span Gas Values

Programming Mode Menus

- Zero Calibration
- Span Calibration
- High Alarm
- Low Alarm
- STEL (Portable Mode only)
- TWA (Portable Mode only)
- Fixed or portable operation
- Radio enable/disable
- Communication interval

Programming Mode

- To enter the Programming Mode, press [M] and [N/-] for 3 seconds.
- Pressing [N/-] steps you through all the screens and then returns to the first programming display

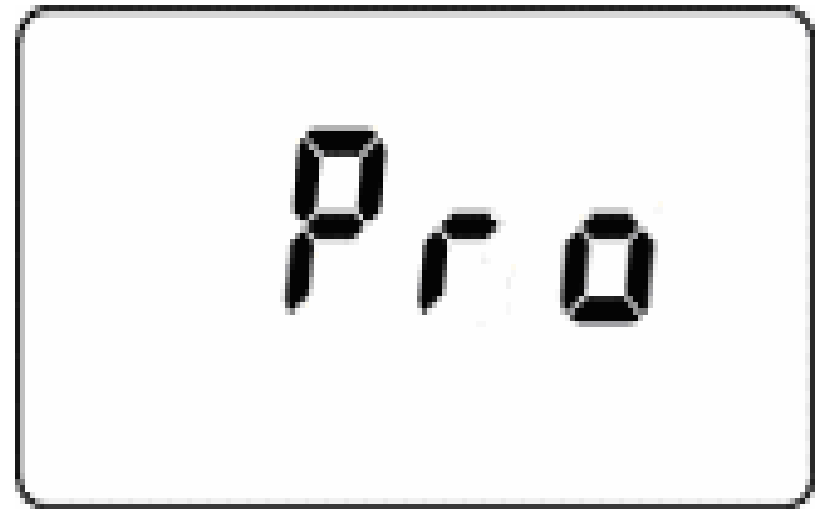

Programming Mode

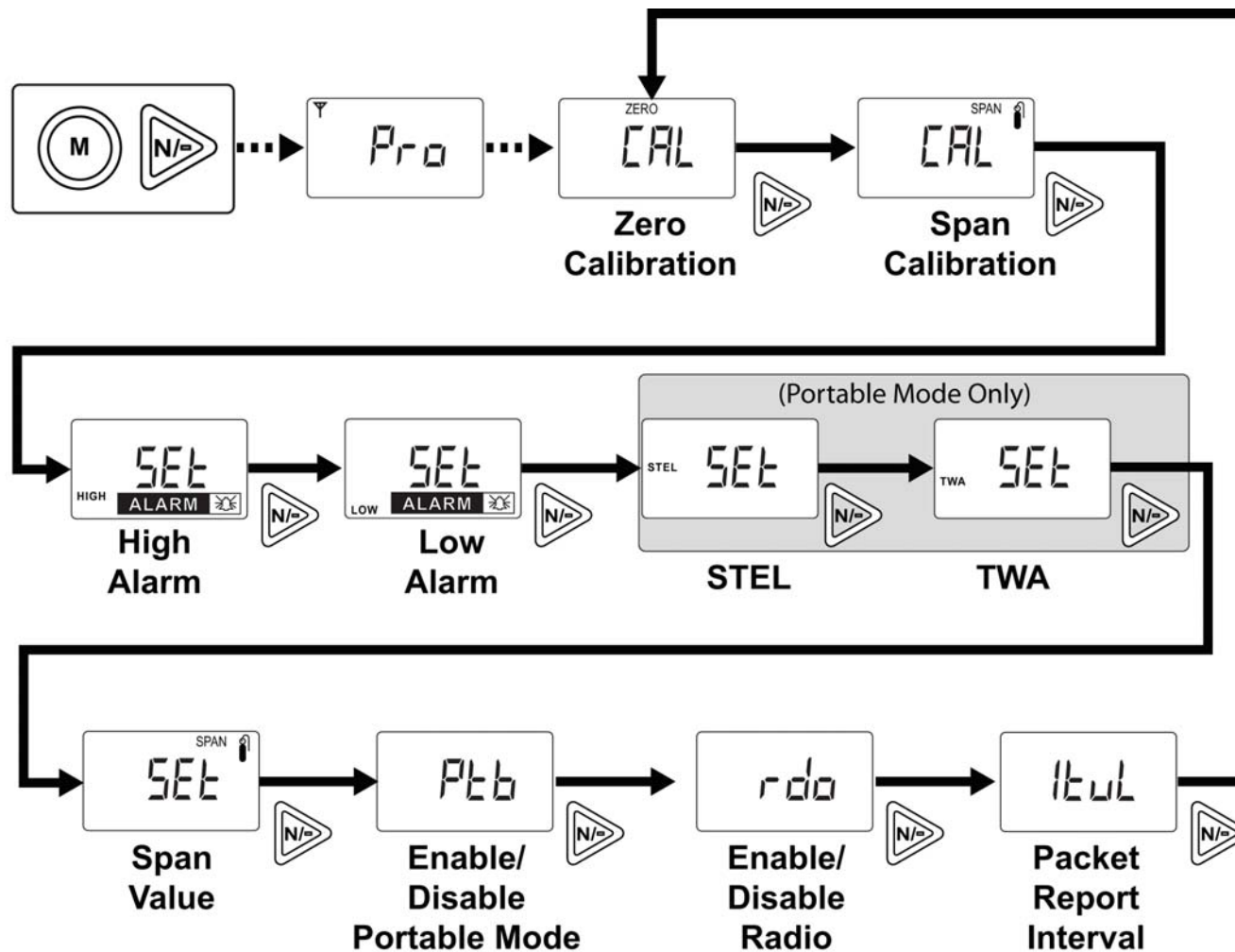

Programming Mode

- Each display alternates between its name and a status message or value.
 - **Note:** You can exit Programming Mode at any time by pressing [M].
- Also, if you do not make a change within one minute, the MeshGuard exits Programming Mode and returns to Detection Mode.

Programming Mode

- Settings can be changed as follows
- When a menu is selected, it flashes between two screens
- Press [M] to exit Program Mode and return to Detection Mode, or press [N/-] to advance to the next menu.
- Press [+ / Y] to enter. The LCD displays “go.”



Exiting Programming Mode

- **You may exit Programming Mode anytime and return to Detection Mode in either of these two ways**
 1. Press [M]. MeshGuard exits Program Mode and shows the current reading in Detection Mode.
 2. Do not press any buttons for 1 minute. MeshGuard automatically exits Programming Mode and returns to Detection Mode, showing the current reading.

Changing Values



- When an editable numerical value is shown, the most significant digit flashes
- Change the value by pressing [+/Y] to increase it, and [N/-] to decrease it.
- Press [M] to advance to the next digit:

Changing Values



- After editing the last digit, press [M].
- A question mark (?) is shown in the display, asking if you want to save the change
- Press [+ / Y] for “yes.”

Changing Values



- The message “dn” indicates the change is done.
- Press [N/-] for “no.”
- A “no” message means that the change was abandoned.
- Press [M] to return to the first digit and continue editing values for that menu.

Zero Calibration

- When “CAL” and “go” are displayed in alternation, and “ZERO” is shown, the MeshGuard is ready to perform a zero calibration.
- Press [+/Y]. The LCD displays “go.”
- The display counts down from 10 to 0.

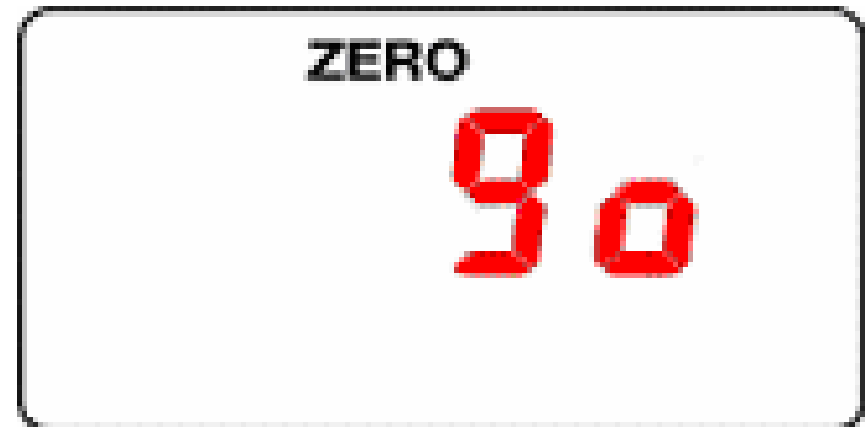

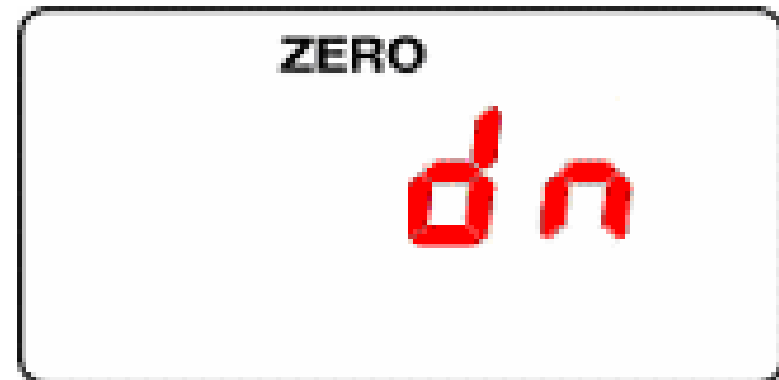

- The display counts down from 10 to 0.
- After the countdown reaches 0, the LCD displays “dn,” for “done.”
- The reading should show 0 (zero).
- Otherwise, repeat the zero calibration.

Zero Calibration

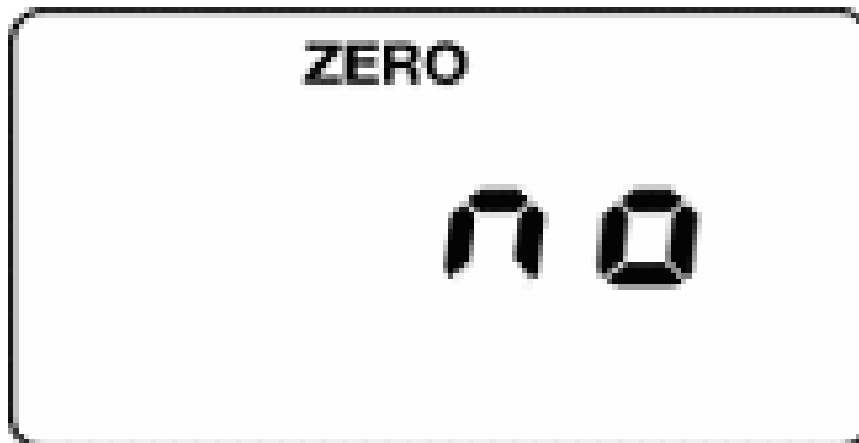
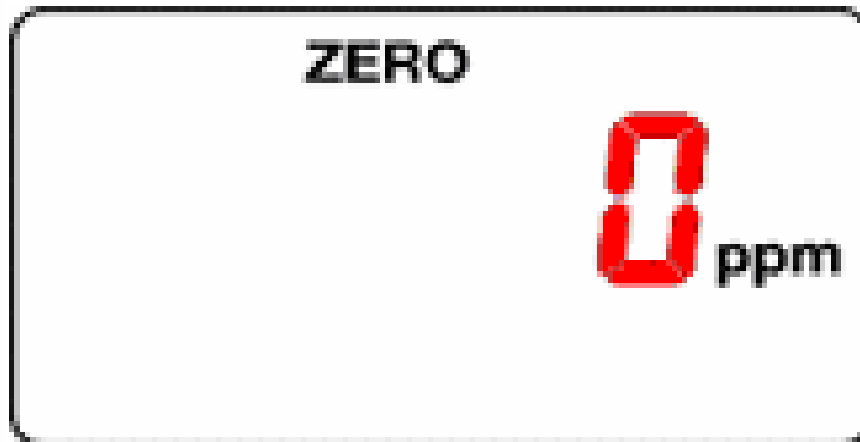

- To stop zero calibration before the countdown reaches 0, press any key.
- The LCD displays “no” and advances to the next programming menu, Span calibration.

Span Calibration

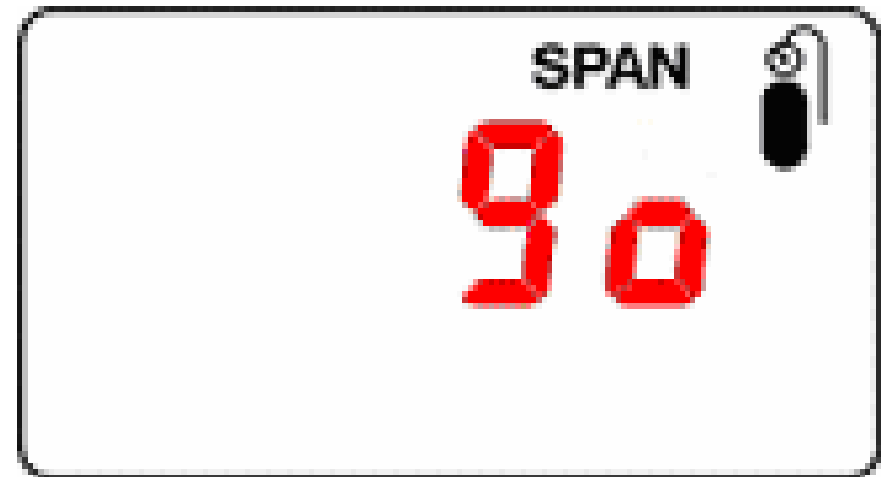

- “CAL” and “go” flash in alternation, and “SPAn” is shown
- The MeshGuard is now ready to perform a span calibration.
- To start calibration, press [+ / Y].

Span Calibration

- The LCD displays “go.”
- The MeshGuard waits for 10 seconds so that you have time to connect the span gas.
- Connect the calibration gas adapter to the MeshGuard, and connect the gas cylinder to the adapter.
- Start the flow of gas.



Span Calibration

- When the gas flow starts, the LCD displays “gAS” and the span concentration value.
- The MeshGuard now counts down to 0.
 - **Note:** The countdown time varies according to the type of sensor used in the MeshGuard.



Span Calibration



- After counting down and reaching 0, the LCD displays “dn.”
- The reading should be the span concentration value.
- Otherwise, the span calibration should be repeated.



Span Calibration

- If the MeshGuard does not detect gas after counting down to 0, the LCD displays “Err” (for “error”).
- The LED glows red and the buzzer sounds to provide extra warning.
- The MeshGuard automatically returns to the span calibration display.
 - **Note:** To stop span calibration before the countdown reaches 0, press any key.
- The LCD displays “no” and advances to the next programming menu, Change High Alarm.

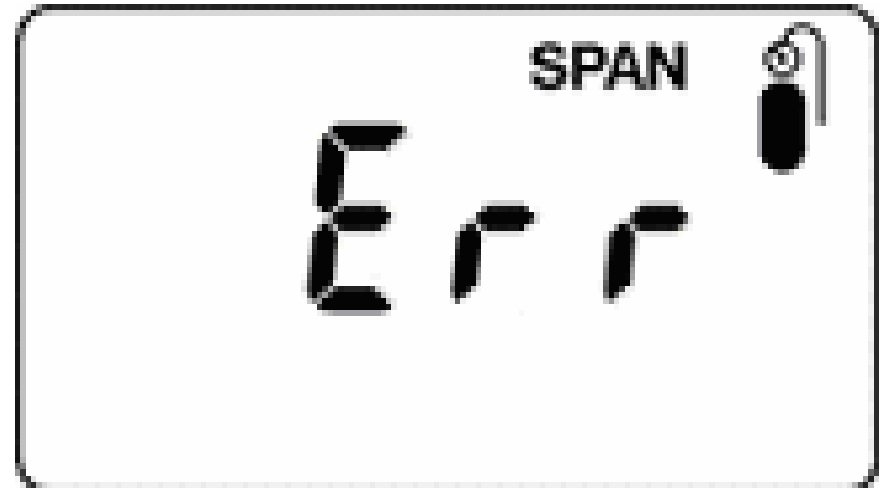

Change High Alarm



- At the menu for changing the High Alarm setting, “ Set” and “ go” flash in alternation, and both “HIGH“ and “ALARM” are shown.
- Press [+ / Y] to enter and change the setting
- Press [M] to go back to Detection Mode or [N / -] to advance to the next menu.

Change High Alarm



- The LCD displays the current value.
- Change the value if necessary.
- Press [+ / Y] to increase the number and [N / -] to decrease it.
- Press [M] to advance to the next digit.
- After moving to the last digit and making changes, press [M].

Change High Alarm



- A question mark (?) is shown in the display, asking if you want to save the change.
- Press [+/Y] for yes. The message “dn” means the change is done.
- Press [N/-] for no. A “no” message means that the change was abandoned.
- Press [M] to return to the first digit.

Change Low Alarm



- At the menu for changing the Low Alarm setting, “ Set” and “ go” flash in alternation, and both “LOW“ and “ALARM” are shown.
- Press [+/Y] to enter and change the setting
- Press [M] to go back to Detection Mode or [N/-] to advance to the next menu.

Change Low Alarm



- The LCD displays the current value.
- Change the value if necessary.
- Press [+ / Y] to increase the number and [N / -] to decrease it.
- Press [M] to advance to the next digit.
- After moving to the last digit and making changes, press [M].

Change Low Alarm



- A question mark (?) is shown in the display, asking if you want to save the change.
- Press [+/Y] for yes. The message “dn” means the change is done.
- Press [N/-] for no. A “no” message means that the change was abandoned.
- Press [M] to return to the first digit.

Change STEL Setting



- **Note:** This menu is only available when the MeshGuard is in Portable Mode.
- If it is in Fixed Mode, you will not see this menu and cannot change its settings.
- “Set” and “go” flash in alternation, and “STEL” is shown.

Change STEL Setting



- Press [+ / Y] to enter and change the setting, [M] to exit and return to Detection Mode, or [N / -] to advance to the next menu.
- The LCD displays current value.
- Change the value if necessary.
- Press [+ / Y] to increase the number and [N / -] to decrease it.
- Press [M] to advance to the next digit.

Change STEL Setting



- After moving to the last digit and making changes, press [M].
- A question mark (?) is shown in the display, asking if you want to save the change.
- Press [+ / Y] for yes. The message “dn” means the change is done.
- Press [N / -] for no. A “no” message means that the change was abandoned.
- Press [M] to return to the first digit.

Change TWA Setting



- **Note:** This menu is only available when the MeshGuard is in Portable Mode.
- If it is in Fixed Mode, you will not see this menu and cannot change its settings.
- “Set” and “go” flash in alternation, and “TWA” is shown.

Change TWA Setting



- Press [+ / Y] to enter and change the setting, [M] to exit and return to Detection Mode, or [N / -] to advance to the next menu.
- The LCD displays the current value. Change the value if necessary.

Change TWA Setting

- Press [+ / Y] to increase the number and [N / -] to decrease it.
- Press [M] to advance to the next digit.
- After moving to the last digit and making changes, press [M]. A question mark (?) is shown in the display, asking if you want to save the change.
- Press [+ / Y] for yes. The message “dn” means the change is done.
- Press [N / -] for no. A “no” message means that the change was abandoned.
- Press [M] to return to the first digit.



Change Span Value

- “Set” and “go” flash in alternation, and “SPAN” and a gas cylinder icon are shown.
- Press [+/Y] to enter and change the setting, [M] to exit and return to Detection Mode, or [N/-] to advance to the next menu.



Change Span Value

- The LCD displays the current value. Change the value if necessary.
- Press [+/Y] to increase the number and [N/-] to decrease it.
- Press [M] to advance to the next digit.
- After moving to the last digit and making changes, press [M]. A question mark (?) is shown in the display, asking if you want to save the change.

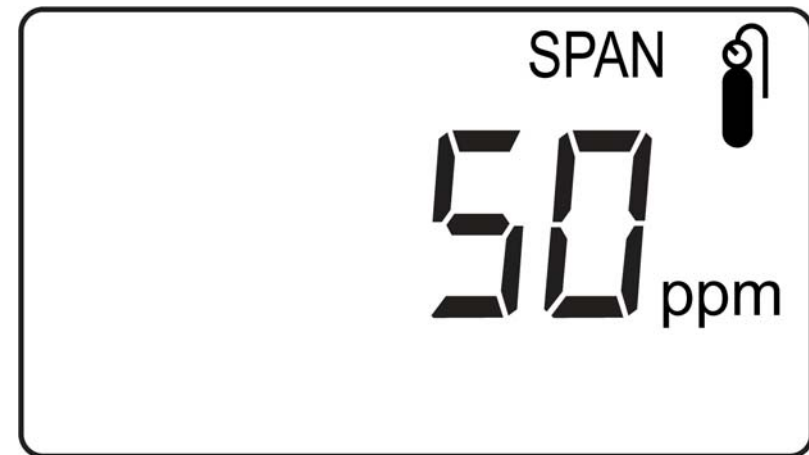

Change Span Value

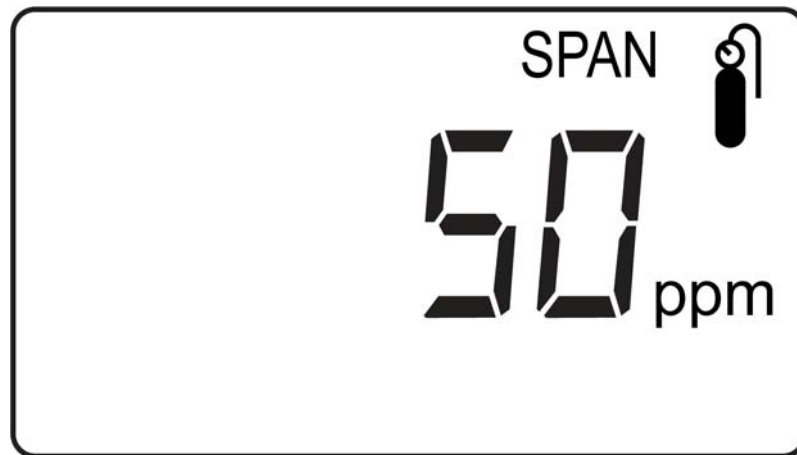

- Press [+/Y] for yes. The message “dn” means the change is done.
- Press [N/-] for no. A “no” message means that the change was abandoned.
- Press [M] to return to the first digit.

Fixed or Portable Operation



SEt



Ptb

- The next menu is for setting the MeshGuard for fixed or portable operation.
- In Portable Mode, STEL, TWA, and Peak readings are included.
- “SEt” and “ Ptb” flash in alternation, to indicate that the MeshGuard can now be set as *fixed* or *portable*.
 - The default value is “fixed.”

Fixed or Portable Operation



SET



Att

- Press [+/Y] to enter and change the setting
- Press [M] to exit and return to Detection Mode, or [N/-] to go to the next menu.
- The LCD displays the current value (enabled or disabled). Change the value if necessary.

Fixed or Portable Operation



En ?

- **Note:** “dIS” means fixed (Portable Mode disabled) and “En” means portable (Portable Mode enabled).

Change Communication Interval

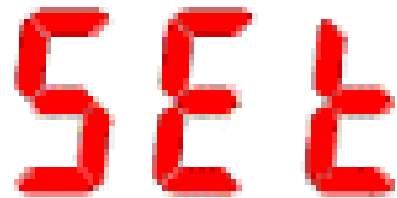

SET

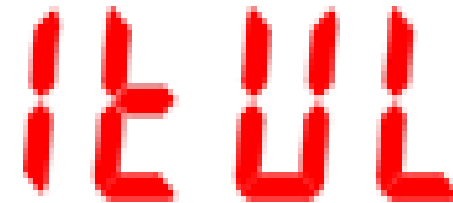

ItUL

- This menu allows you to change the interval between wireless transmissions.
- “SET” and “ItUL” flash, to indicate that you can change the interval.
- The interval can be set to 10, 30, 60, 300, or 600 seconds.
 - **Note:** The default interval is 30 seconds.
- Press [+ / Y] to enter and change the setting, [M] to exit and return to Detection Mode, or [N / -] to advance to the next MENU.

Turning off the MeshGuard



OFF

- Hold down the [M] key through the “5...4...3... 2... 1... oFF” sequence.
- The monitor is off when the display is blank.
- Release the [M] key.
- The MeshGuard is now off.