

3M Occupational Health and Environmental Safety Division

3M™ NoisePro™ Personal Noise Dosimeter



NoisePro Series Quick Start Guide



The 3M logo, consisting of the letters "3M" in a bold, red, sans-serif font.

Quick Start Steps

Turn On

1. Turn on the NoisePro by pressing and releasing  key. The display will initialize and sequence to the "START" screen.
2. If "LOBAT" is in display, put new batteries in the NoisePro.

Reset



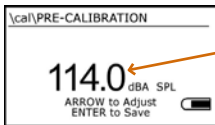

3. Press and hold **RESET** softkey. The display counts down from 5 then shows "Sessions DELETED" for NoisePro DLX or "Studies DELETED" for the NoisePro DL and NoisePro models.
 - **NOTE:** Resetting the NoisePro erases all previously stored data from memory.

Pre-Calibration



4. From the START menu, press the **CAL** softkey. The CAL screen appears with CALIBRATE highlighted.
5. Turn the calibrator on, connect microphone to calibration adapter, connect calibration adapter to calibrator.



Pre-Calibration screen and matching output

6. Press  and the PRE-CALIBRATION screen appears. If required, press the   keys to adjust the displayed value to match the calibrator output. Press  key to save (store) the pre-calibration.
7. Press and release  key to return to START screen.



Begin Study

8. Clip the microphone, with windscreen attached to one's shoulder and secure the NoisePro to the person's waist.
9. Press  key to begin data collection. The run icon  will appear in the lower right corner of the display.





End Study

10. Press  key to stop study. The pause icon "II" will appear in the lower right corner of the display.

Post-Calibration

11. From the START menu, press the CAL softkey. The CAL screen appears with CALIBRATE highlighted.
 12. Turn the calibrator on, connect microphone to calibration adapter, connect calibration adapter to calibrator.
 13. Press  key and POST-CALIBRATION screen appears. Press  key to save (store).
- **NOTE:** in a Post-Calibration, the SPL value cannot be adjusted.

View Data

14. From the "START" screen, highlight "VIEW CURRENT STUDY" and press the  key. Press   keys to scroll through LEVEL, AVG, and DOSE measurements. Press   keys to scroll to other dosimeter measurements.
- **NOTE:** the displayed measurement screens are dependent on the model type and number of defined setups/virtual meters on your instrument. (Examples: NoisePro DLX dosimeters 1, 2, 3, & 4; NoisePro & NoisePro DL dosimeters 1 & 2).

NoisePro Overview



NoisePro Case

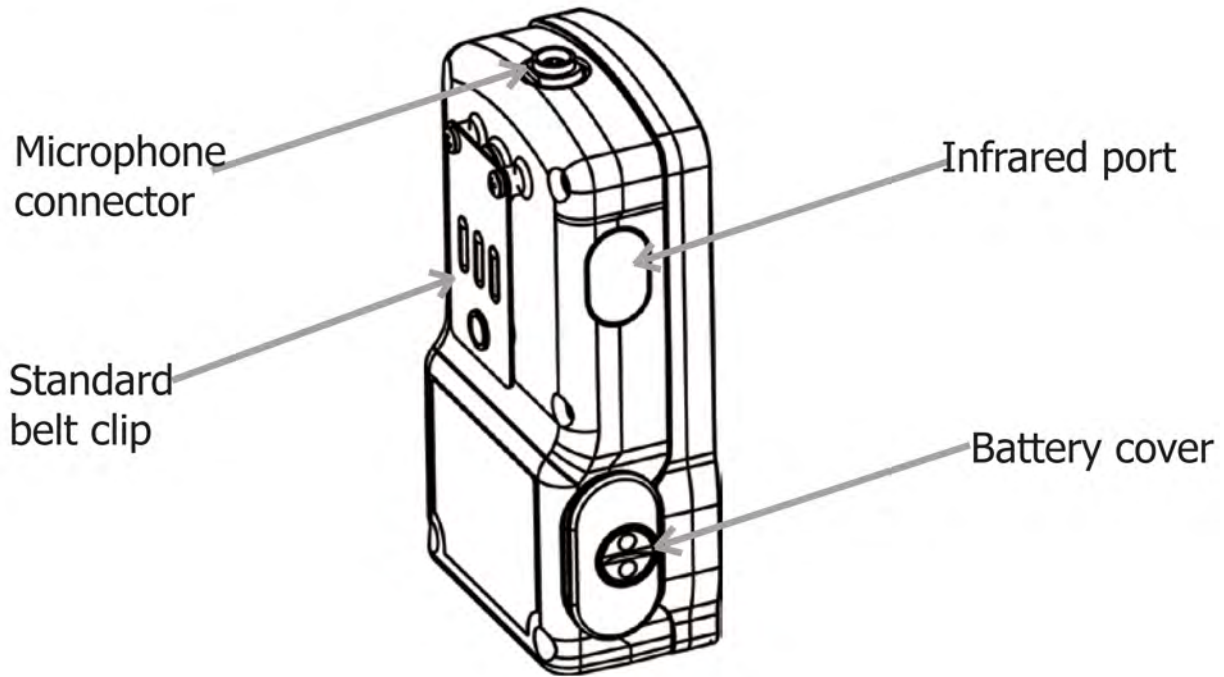

Communicating



Communicating with a USB port with an infrared cable connection

Common Noise Dosimeter Terms

Criterion Level (CL) - expressed in decibels (dB), it is the maximum allowable accumulated noise level that results in 100% dose. Regional noise standards specify criterion level.

Dose - expressed in percent, it is the percent of the maximum exposure that has accumulated over the run time. 100% is the maximum allowable exposure. 100% dose occurs for an average sound level equal to the criterion level for an 8 hour period.

Exchange Rate (Doubling Rate) (ER)- the decibel level that would or halve the sound exposure. For instance with a 3 dB exchange rate the sound exposure doubles with every 3 dB increase, and the sound exposure is halved every 3 dB decrease. Regional noise standards specify the exchange rate.

Lavg - stands for "level average" and is the average sound level measured over the run time.

Leq - stands for "level equivalent" and is the average sound level measured over the run time but is calculated with a 3 dB exchange rate with no threshold.

Max Level - the highest weighted sound level that occurred, also allowing for the response time that the meter is set to. If the meter is set for A weighting with Slow response then the Max level is the highest A weighted sound that occurred applying the Slow response time.

Peak level - the highest instantaneous sound level that the microphone detects. Unlike the Max Level, the peak is detected independently of the slow or fast response time the unit is set for.

Response Time (Fast, Slow, Impulse) - how quickly the circuitry responds to changing noise levels. These are ANSI/IEC defined response times. Most occupational noise standards require slow response time.

Threshold Level (Cut Off) - noise levels below the threshold are integrated as zero decibels. This will affect Lavg, Leq, TWA, and Dose values. Most regional noise standards specify the threshold level, if any.

TWA (Time Weighted Average) - takes the noise exposure accumulated in the run time and applies an eight hour time period. If the meter was in run for 5 minutes, the TWA takes that 5 minutes of noise input and averages it into an 8 hour run time. The TWA in this case would be much lower than the Lavg.

Weighting (A,C,Z) - frequency filters that cover the frequency range of human hearing. A weighting greatly attenuates high and low frequency noise to mimic how the human ear hears noise. C weighting also attenuates high and low frequency noises, but not nearly as much as A weighting. Z weighting does not apply any attenuation, or weighting, to any frequency. Most regional noise standards require a weighted measurements.

Pre-Defined Setups

Six of the nine dosimeter setups are factory-defined and conform to standards established for noise dosimetry in the United States and the European Union. It is recommended to check your regulations prior to data collection.

OSHA HC (Hearing Conservation)

- "A" Weighting
- 90 dB CL
- Slow response
- 80 dB Threshold
- 5 dB ER

OSHA PEL (Permissible Exposure Level)

- "A" Weighting
- 90 dB CL
- Slow response
- 90 dB Threshold
- 5 dB ER

MSHA HC (Hearing Conservation)

- "A" Weighting
- 90 dB CL
- Slow response
- 80 dB Threshold
- 5 dB ER

MSHA PEL (Permissible Exposure Level)

- "A" Weighting
- 90 dB CL
- Slow response
- 90 dB Threshold
- 5 dB ER

ACGIH

- "A" Weighting
- 85 dB CL
- Slow response
- 80 dB Threshold
- 3 dB ER

200310EC (EU Directive)

- "A" Weighting
- 85 dB CL
- Slow response
- No Threshold
- 3 dB ER



3M

QUEST
TECHNOLOGIES
now part of 3M

Occupational Health & Environmental Safety Division

Quest Technologies, a 3M Company
ISO 9001 Registered Company
ISO 17025 Accredited Calibration Lab
1060 Corporate Center Drive
Oconomowoc, WI 53066
Customer Service: 262-567-9157
Toll Free: 800-245-0779
www.3m.com/detection

www.questtechnologies.com

Please recycle. Printed in USA.
© 2011 3M
All rights reserved.
098-574 Rev.D 1/12